



This is a digital copy of a book that was preserved for generations on library shelves before it was carefully scanned by Google as part of a project to make the world's books discoverable online.

It has survived long enough for the copyright to expire and the book to enter the public domain. A public domain book is one that was never subject to copyright or whose legal copyright term has expired. Whether a book is in the public domain may vary country to country. Public domain books are our gateways to the past, representing a wealth of history, culture and knowledge that's often difficult to discover.

Marks, notations and other marginalia present in the original volume will appear in this file - a reminder of this book's long journey from the publisher to a library and finally to you.

### **Usage guidelines**

Google is proud to partner with libraries to digitize public domain materials and make them widely accessible. Public domain books belong to the public and we are merely their custodians. Nevertheless, this work is expensive, so in order to keep providing this resource, we have taken steps to prevent abuse by commercial parties, including placing technical restrictions on automated querying.

We also ask that you:

- + *Make non-commercial use of the files* We designed Google Book Search for use by individuals, and we request that you use these files for personal, non-commercial purposes.
- + *Refrain from automated querying* Do not send automated queries of any sort to Google's system: If you are conducting research on machine translation, optical character recognition or other areas where access to a large amount of text is helpful, please contact us. We encourage the use of public domain materials for these purposes and may be able to help.
- + *Maintain attribution* The Google "watermark" you see on each file is essential for informing people about this project and helping them find additional materials through Google Book Search. Please do not remove it.
- + *Keep it legal* Whatever your use, remember that you are responsible for ensuring that what you are doing is legal. Do not assume that just because we believe a book is in the public domain for users in the United States, that the work is also in the public domain for users in other countries. Whether a book is still in copyright varies from country to country, and we can't offer guidance on whether any specific use of any specific book is allowed. Please do not assume that a book's appearance in Google Book Search means it can be used in any manner anywhere in the world. Copyright infringement liability can be quite severe.

### **About Google Book Search**

Google's mission is to organize the world's information and to make it universally accessible and useful. Google Book Search helps readers discover the world's books while helping authors and publishers reach new audiences. You can search through the full text of this book on the web at <http://books.google.com/>

UC-NRLF



#B 32 897

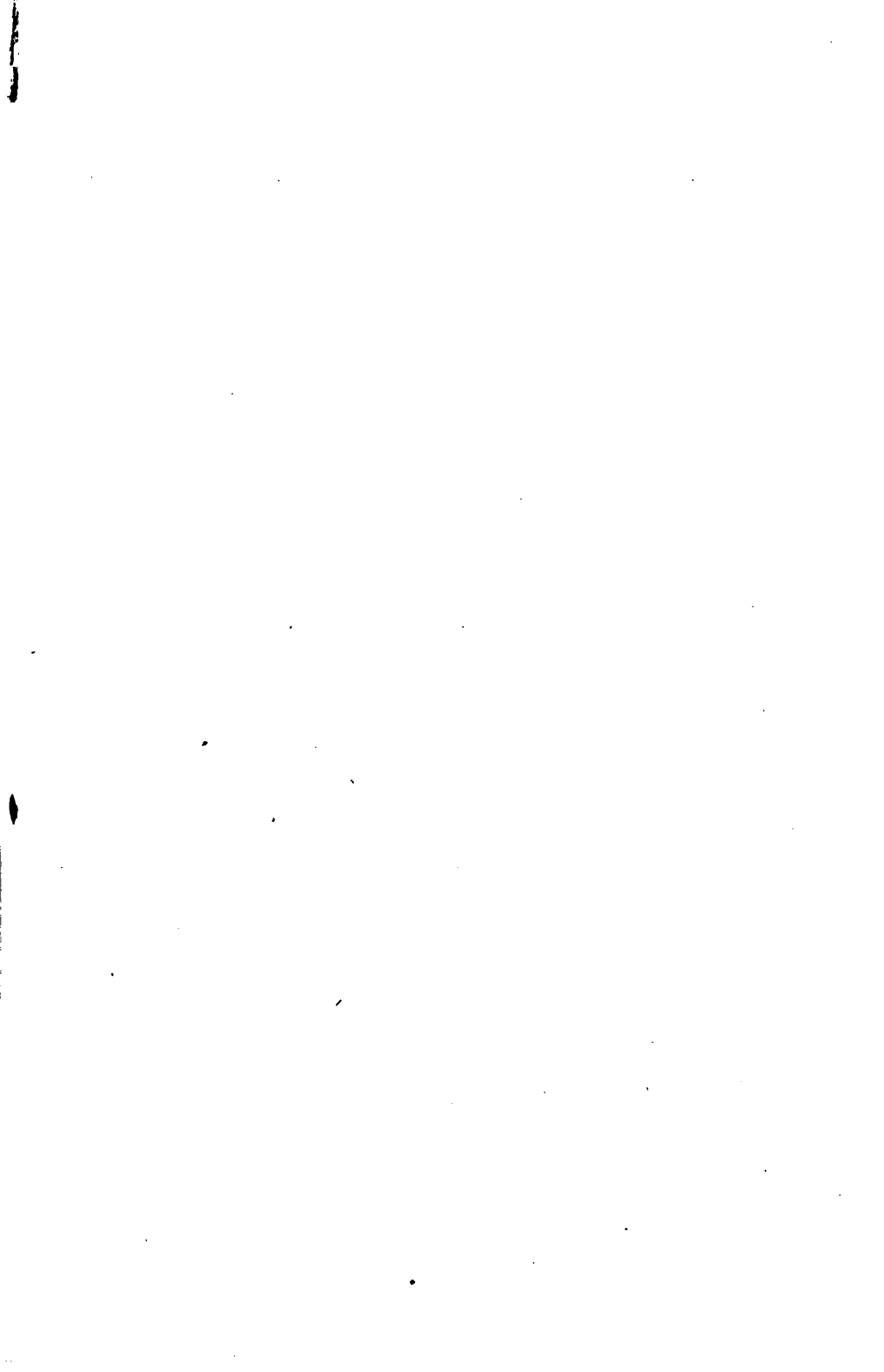
THE  
A-B-C of  
AVIATION

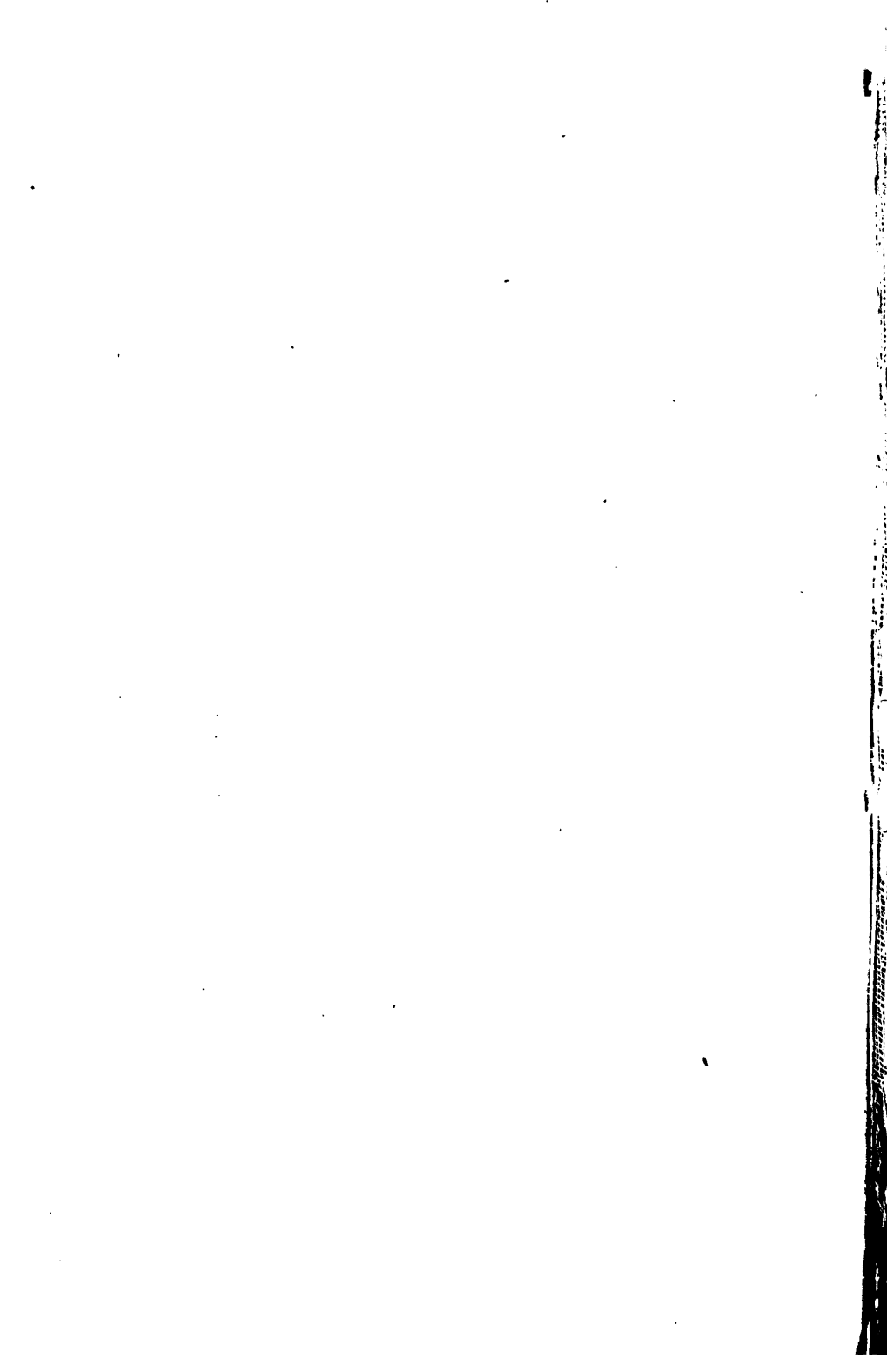
PAGE



1919 EDITION







**THE  
A-B-C OF AVIATION**

By  
Captain VICTOR W. PAGÉ  
Sig. R. C., A. S.

has been censored, and passed for publication, by The Chief Military Censor,  
Washington, D. C.



## NOTICE

The author of this book, Capt. Victor W. Pagé, Sig. R. C., A.S., having been called to France for service, had not the opportunity of reading the proof pages of this book before its publication, and, therefore, could not make any necessary corrections before its publication.

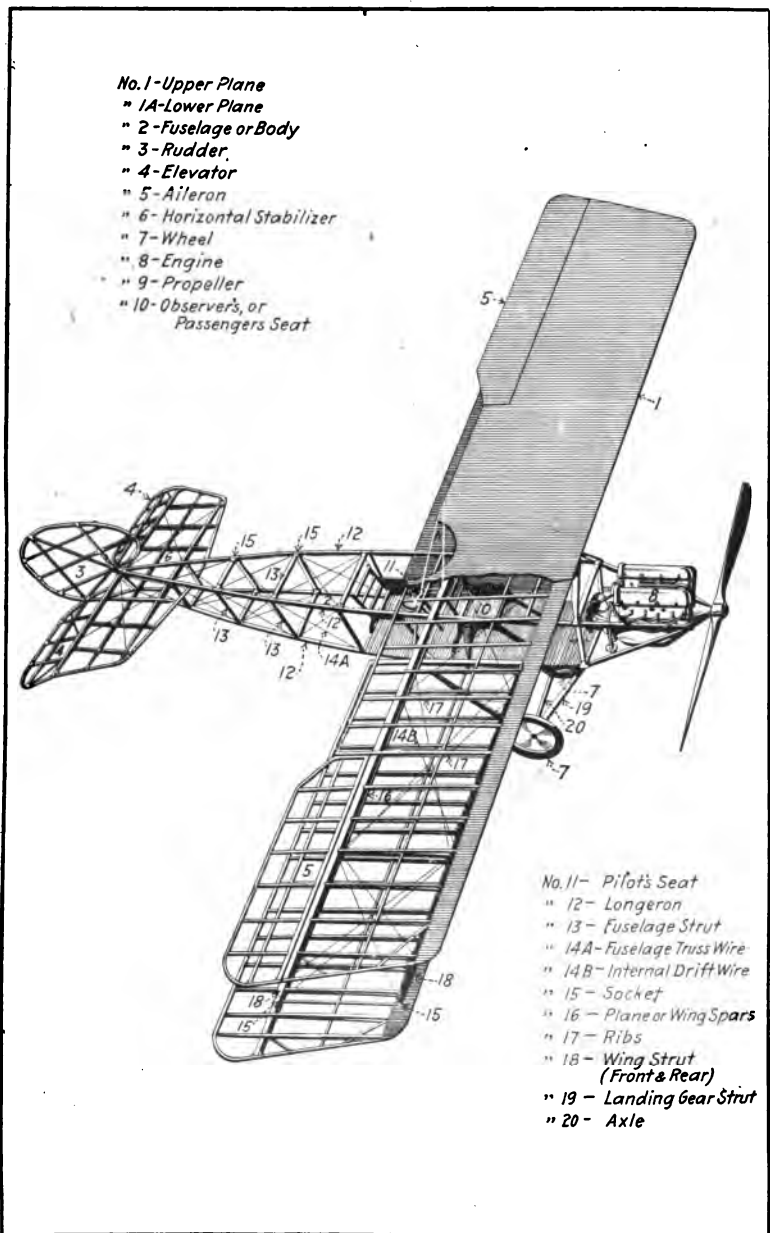
The Publishers will appreciate it if the reader will, therefore, call to their attention any seeming errors.

THE NORMAN W. HENLEY PUBLISHING Co.  
2 West 45th St., New York City.









- No. 1-Upper Plane
- " 1A-Lower Plane
- " 2-Fuselage or Body
- " 3-Rudder,
- " 4-Elevator
- " 5-Aileron
- " 6-Horizontal Stabilizer
- " 7-Wheel
- " 8-Engine
- " 9-Propeller
- " 10-Observers, or  
Passengers Seat

- No. 11- Pilot's Seat
- " 12- Longeron
- " 13- Fuselage Strut
- " 14A- Fuselage Truss Wire
- " 15- Socket
- " 16- Plane or Wing Spars
- " 17- Ribs
- " 18- Wing Strut  
(Front & Rear)
- " 19- Landing Gear Strut
- " 20- Axle

PLATE I.—Part Sectional View of Typical Airplane, Showing Important Parts.

# *The* A-B-C *of* A V I A T I O N

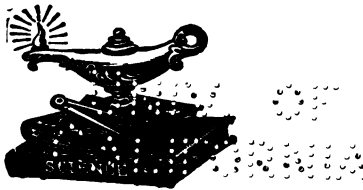
A COMPLETE, PRACTICAL TREATISE OUTLINING CLEARLY THE ELEMENTS OF AERONAUTICAL ENGINEERING WITH SPECIAL REFERENCE TO SIMPLIFIED EXPLANATIONS OF THE THEORY OF FLIGHT, AERODYNAMICS AND BASIC PRINCIPLES UNDERLYING THE ACTION OF BALLOONS AND AIRPLANES OF ALL TYPES. A NON-TECHNICAL MANUAL FOR ALL STUDENTS OF AIRCRAFT

THIS BOOK INCLUDES INSTRUCTIONS FOR LINING UP AND INSPECTING TYPICAL AIRPLANES BEFORE FLIGHT AND ALSO GIVES EASILY UNDERSTOOD RULES FOR FLYING

BY

CAPTAIN VICTOR W. PAGÉ, SIG. R. C., A. S.

MEMBER SOCIETY OF AUTOMOTIVE ENGINEERS; LATE CHIEF  
ENGINEER OFFICER, SIGNAL CORPS AVIATION SCHOOL,  
HAZELHURST FIELD, MINEOLA, L. I.



CONTAINS VALUABLE INSTRUCTIONS FOR ALL AVIATION STUDENTS, AIRPLANE MECHANICIANS, SQUADRON ENGINEERING OFFICERS AND EVERYONE INTERESTED IN CONSTRUCTION AND UP-KEEP OF AIRPLANES

A SIMPLIFIED TEXT SUITABLE FOR SCHOOL OR HOME STUDY

NEW YORK  
THE NORMAN W. HENLEY PUBLISHING COMPANY

2 WEST 45th STREET

1918

TL 545  
12

COPYRIGHT, 1918  
BY  
THE NORMAN W. HENLEY PUBLISHING CO.

PRINTED IN U. S. A.

TO THE  
PUBLISHERS

COMPOSITION, ELECTROTYPING AND PRESSWORK  
BY THE PUBLISHERS PRINTING CO., NEW YORK

## PREFACE

As a result of considerable experience obtained last year in instructing prospective aviators and mechanics, and in response to an insistent demand, the writer prepared a treatise on airplane power-plants called "Aviation Engines," which has met with a very gratifying reception and which is used by many aviation schools as a text on this subject. Instructors who are using the engine book successfully and numerous students who have derived some benefit from its contents have asked for an exposition of the airplane in which its operation and repair principles would be written in the same simple non-technical manner as the treatise referring to power-plants.

To meet this demand, the present treatise has been prepared and instructors, both civilian and army officers, who have read the manuscript have pronounced the book as one well suited for instruction work. It is not intended to be an engineering treatise, nor is it intended to consider technical points that can interest only the designer. At the same time, it is necessary to consider some of the basic principles of airplane flight and aerofoil design in simple language so the student may obtain a complete grasp of the subject. For those seeking technical knowledge, numerous excellent reference works are available. Very simple books for boys are also on the market, so neither of these extremes has been considered in preparing this text, because any need of the above can be met with existing standard works.

The notes on inspection and lining up of airplanes have been purposely made brief and apply to airplanes in general, as well as the specific type illustrated. This also applies to the instructions, or rather observations, on flying which have been suggested by a pilot of considerable experience. Every effort has been made to explain all technical points and numerous diagrams have been prepared to amplify the text. It is

believed that this treatise, owing to its having been prepared with a full realization of the average student's needs, should be well adapted for instruction work on general principles of mechanical flight and their practical application in both lighter-than-air craft and airplanes. The book is as well adapted to home study work as it is for classroom instructions.

THE AUTHOR.

OCTOBER, 1918.

## ACKNOWLEDGMENT

THE author desires to acknowledge the valuable assistance given by 1st Lieut. Chas. A. Muller, Sig. R. C., A. S., who was associated with him in instructing flying cadets at the Signal Corps Aviation School, Hazelhurst Field, Mineola, L. I., in Aeronautical Science, and who furnished many ideas for making this treatise one well suited for instruction work. The wide experience of Lieut. Muller, who was a pioneer airplane designer and constructor, was utilized to good advantage in checking up the manuscript and drawings prior to publication. Assistance given by Mr. Max Goodnough, Aeronautical Mechanical Engineer, S. S. L., and the Engineering Dept. of the Curtiss Aeroplane and Motor Co. also proved of value in compiling the original instructions for students which form the basis of this treatise.

THE AUTHOR.

OCTOBER, 1918





# TABLE OF CONTENTS

## CHAPTER I

### AIRCRAFT TYPES

Force of Air in Motion—Ascensional Power of Warm Air—Lifting Power of Hydrogen-Gas—Types of Dirigibles—Why the Airplane is Best—Attraction of Gravity—Elementary Airplane Principles—Kite Supported by Air in Motion—Air Resistance—Table 1: Resistance of Aerofoil Sections—Table 2: Wind Pressure at Various Velocities—How Airplanes Differ . . . . . 13-27

## CHAPTER II

### LIGHTER-THAN-AIR CRAFT

Spherical Balloon Parts—Hydrogen Gas for Military Balloons—Control of Free Balloons—Free or Captive Spherical Balloons of Little Value in Military Work—Kite Balloons Best for Observation Work—Dirigible Balloon Types: The Zeppelin—Dirigible Balloon Types: The Blimp . . . . . 28-38

## CHAPTER III

### EARLY AIRPLANES AND GENERAL DESIGN CONSIDERATIONS

Henson Airplane—Philips Multiplane—Maxim's Flying Machine—Ader's and Other Machines—First Flights of Wright Brothers—Lack of Speed a Drawback—Plane Forms—Bird and Plane Form Compared—Airplane Moves in Three Planes—Table 3—Birdflight Difficult to Imitate—Comparing Airplane and Bird Flight—Plane Balancing Principles—Airplane Control Methods—Use of Vertical Rudder . . . . . 39-53

## CHAPTER IV

### DESIGN AND CONSTRUCTION OF AEROFOILS

How Plane Performance May be Gauged—Meaning of Lift and Drift—Lift-Drift Value for Rectangular Plane—Meaning of Center of Pressure—Properties of Cambered Aerofoils—Leading Edge Should be Curved Down—Best Design of Cambered Aerofoil—Table 4—Table 5—Effect of Wing Loading on Camber—Effect of Varying Lower Camber—Pressure Distribution on Aerofoils—Position of Maximum Efficiency—Position of Center of Pressure—What is Meant by Critical Angle or Burble Point—Greatest Lift Produced by Upper Surface—Table 6 . . . . . 54-75

## Table of Contents

### CHAPTER V

#### ARRANGEMENT, CONSTRUCTION, AND BRACING OF AIRPLANE WINGS

Monoplane or Biplane—Effect of Gap—Table 7—Effect of Stagger—Plane Forms—Securing Uniform Pressure Distribution—Airplane Wing Construction—Wing Covering Fabric—Why “Dope” is Used for Wings—How Fabric is Fastened—Airplane Wing Bracing—Loads on Airplane Wing Wires—Airplane Wing Form—Planes with Longitudinal Dihedral—Influence of Lateral Dihedral—Airplane Wing Bracing—Side Bracing of Airplane Wings—Airplane Bracing Wires—Typical Wire Bracing Arrangements . . . . . 76-108

### CHAPTER VI

#### AIRPLANE FUSELAGE CONSTRUCTION

Early Wright Starting System—Design of Fuselage Framework—Airplane Design Considerations—Reduction of Parasitic Resistance—Airplane Fuselage Forms—Complete Enclosure Important—How Coincidence of Centers is Obtained—Landing Gear Forms—Wheel Tread Depends on Spread—Woods for Airplane Parts—Metals Used in Airplanes—Table 8—Table 9—Table 10 . . . . . 109-135

### CHAPTER VII

#### AIRPLANE POWER-PLANTS

Aerial Motors Must be Light—Factor Influencing Power Needed—Airplane Engine Forms—Airplane Engine Installation—Standard S. A. E. Engine Bed Dimensions—Installing Rotary and Radial Cylinder Engines—Characteristics of Typical American Pre-War Aviation Engines . . . . . 136-151

### CHAPTER VIII

#### AIRPLANE PROPELLER CONSTRUCTION AND ACTION

When Screw Works in Air—Mathematical Consideration of Propeller Pitch—Propeller Definitions—Propeller Manufacturing Practice—Theories of Screw Propeller Action—How Propellers are Balanced—The Disc Theory—The Blade Theory . . . . . 152-170

### CHAPTER IX

#### AIRPLANE EQUILIBRIUM AND CONTROL PRINCIPLES

Factors Regulating Equilibrium and Stability—Why Small Control Surfaces are so Effective—Control Methods of Early Airplanes—Standard Control Systems of To-day—The Function of Balanced Control—Why the Airplane is Banked in Turning—Instruments for Navigating Airplanes—Suggestions for the Student in Flying—Run Motor Slowly to Warm It—How to Take Off—How to Attain Altitude and Handle Machine—Precautions When Landing—Danger in Stalling—Control in Making Turns—Flying Learned Only by Practice—Important Hints . 171-197

**CHAPTER X**

**UNCRATING, SETTING UP, AND ALIGNING AIRPLANE**

To Unpack Curtiss Biplane—How Parts are Packed—Examination of Parts before Assembly—Assembling Landing Gear to Fuselage—Panel Assembly—Main Panels Joined to Fuselage—Adjustment for Dihedral—Methods of Checking Dihedral—Checking Stagger—Wash-in and Wash-out—Tail Assembly—Landing Gear—Horizontal Stabilizer—Vertical Stabilizer—Elevators—Rudder—Aileron Adjustment—Rudder Control Adjustment—Elevator Control Adjustment—General—Checking Alignment of Wings and Fuselage—String and Straight Edge Method of Lining a Fuselage—Typical Airplanes in Practical Use . . . . . 198-231

**CHAPTER XI**

**INSPECTING AIRPLANE BEFORE FLIGHT**

Inspection of Propeller—Power Plant—Gasoline and Oil System—Cooling System Parts—Landing Gear—Fuselage Nose—Wing Fittings—Brace Wires—Struts—Ailerons—Rudder—Stabilizers—Control Wires—Fuselage Interior—Tail Skid . . . . . 232-244

**CHAPTER XII**

**STANDARD AIRPLANE NOMENCLATURE**

Definitions of All Terms Used in Connection with Aviation Approved by National Advisory Committee for Aeronautics . . . . . 245-257



# THE A. B. C. OF AVIATION

## CHAPTER I

### AIRCRAFT TYPES

**Force of Air in Motion—Ascensional Power of Warm Air—Lifting Power of Hydrogen Gas—Types of Dirigibles—Why the Airplane is Best—Attraction of Gravity—Elementary Airplane Principles—Kite Supported by Air in Motion—Air Resistance—Table 1, Resistance of Aerofoil Sections—Table 2, Wind Pressure at Various Velocities—How Airplanes Differ.**

THE navigation of the air, which has been the dream of mankind for ages, has only been realized in recent years. Practical aircraft have been built in definite forms that can easily be classified, and also in several experimental types that are little known and which have been discarded in favor of the types known to be practical. The air is a gas that surrounds the earth and which is said to extend above the earth's surface for about 40 miles, though the density becomes less and the air becomes rarer as the distance above the earth's surface increases. Above a certain height, about four or five miles from sea level, it is very difficult for human beings to breathe because of the rarity of the air. We are so used to moving about in the air that many consider it an almost intangible substance and do not realize that 16 cubic feet of air will weigh about a pound and that it exerts a pressure of about 15 pounds per square inch surface on everything. We are so constituted that this load is not appreciable to us any more than the force of gravity.

**Force of Air in Motion.**—Air in motion may exert considerable force. A gentle breeze creates very slight pressure, but a cyclone or hurricane, which means air travelling at a rate of from 75 to 100 miles per hour, can do considerable damage. Much destruction is caused by tornadoes due to the great pressure of air travelling at a high speed, and which has sufficient velocity to uproot large trees and tear buildings

apart. Winds are caused by the conflict between rising air currents due to the lesser weight of heated air which rises from the earth's surface and the down currents of cold and therefore heavier air which rushes down to take its place. The physical contour of the earth and variations of temperature as well as seasons of the year all have their influence on air movements termed winds.

#### ASCENSIONAL POWER OF WARM AIR

The ascensional power of warm air was well known to the ancients, and the first craft to navigate, or rather be supported

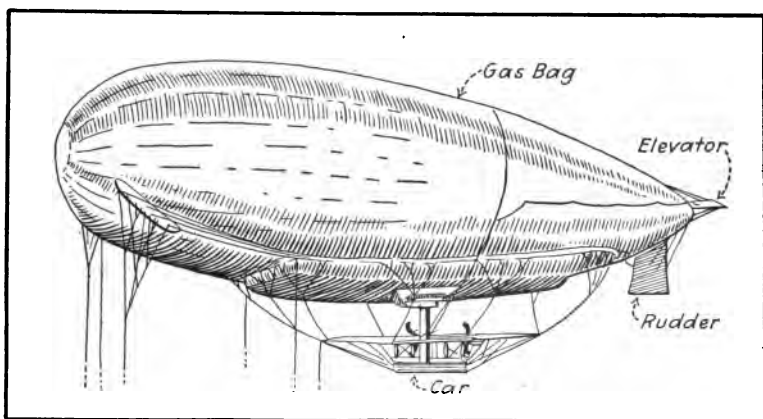


Fig. 1. Non-rigid Type Dirigible Balloon.

by the air, were very large globular or pear-shaped bags of paper or parchment filled with hot air and smoke from a fire burning beneath the opening in the bottom of the bag. A cork or piece of wood floats on water because it is lighter than the supporting medium, a stone sinks because it is heavier than water. A bag filled with hot air, smoke and gases, resulting from combustion, is lighter than the surrounding cold air it displaces and will rise because it is of lesser weight than the supporting medium. The first airships were of the lighter than air type and are called balloons. This type is made in two forms, aerostats or spherical balloons free to rise in the air and blown hither and yon at will of the elements, and dirigible balloons, which are driven by power and which may be steered

by special directional members or rudders. The free balloon is of little value except for exhibition purposes. The kite balloon, however, which is held captive is a splendid type for military observation purposes.

**Lifting Power of Hydrogen Gas.**—Practical balloons are made up of various textile fabrics, such as silk or linen, which are very closely woven and which are impregnated with rubber compound to lessen the porosity in order that they may retain gas. This cloth is cut into strips of the proper size and shape which are sewed together to form the envelope or gas bag. The seams are covered with strips of rubberized tape to insure a gas-retaining joint. The bag is filled with hydrogen gas, the

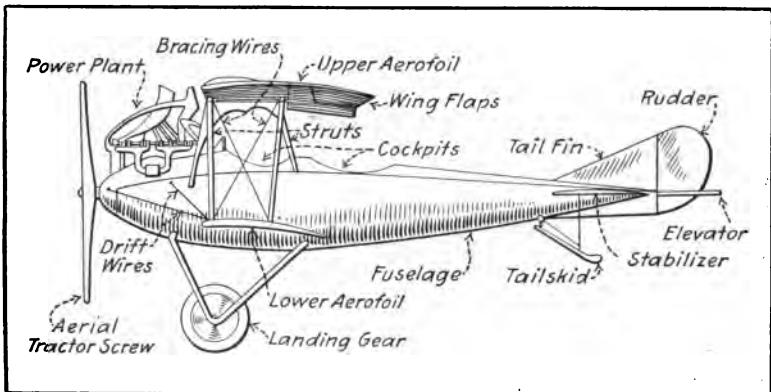


Fig. 2. Side View of Typical Biplane, Showing Important Parts.

lightest known element. One cubic foot of this gas is capable of lifting one ounce weight, therefore a bag with a capacity of 32,000 cubic feet would be able to lift one ton or 2,000 pounds, this weight including the gas, bag and basket and objects raised from the ground. The kite balloons are shaped like a big sausage instead of a pear or globe and are allowed to rise to the desired height by unwinding a cable from a power-driven winch.

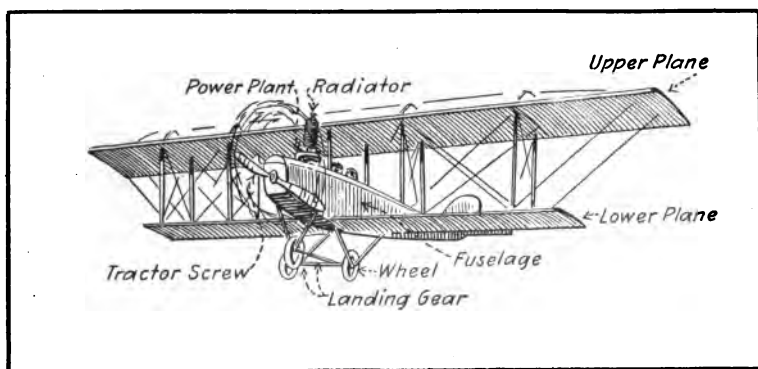
#### TYPES OF DIRIGIBLES

Dirigibles are made in two types, called non-rigid and rigid. The former class includes approximately cigar-shaped bags carrying a basket or body member suspended from the



bag by a series of slings, these being attached either to a netting or to special fabric anchorage pieces sewed to the bag. The bag holds its shape because it is distended by the internal gas pressure. The rigid type, of which the well-known Zeppelin airship is an example, has a metallic framework that divides the main gas container into sections, the only function of the gas bags being to hold the gas. The framework shapes the bag and permits of easy attachment of the "gondolas" or cars carrying the power plants close to the body of the ship. These types will be considered more in detail in proper sequence.

Heavier-than-air machines may be divided into three types: airplanes, helicopters and ornithopters. The first



**Fig. 3. Tractor Biplane in Flight.**

named is made in three different patterns designated by the number of supporting surfaces or wings it has. A monoplane has one wing; a biplane, two; and a triplane, three. The helicopter is a machine that depends on lifting screws for sustentation and propellers for securing movement in a horizontal plane. The ornithopter is a type devised to imitate bird flight and sustentation is supposed to be derived by the flapping of wings. Neither of the two latter forms is practical or seems to have any future. The airplane in its simplest or monoplane form consists of a body to carry the pilot, power plant and controlling members, supported by wings, one at each side of the body. The engine turns an aerial propeller which pulls the machine through the air because the air pressure under the wing and

the suction effect on top of the wing exerts a lift greater than the weight of the machine if it is drawn through the air with sufficient speed. The airplane in its various forms will also be discussed in succeeding installments. The airplane is the most practical type of machine to navigate the air and thousands are in daily use. Its principle of operation is easily understood. If wind moving at high velocity exerts pressure, drawing an object through the air at high speed will produce pressure against it. If this is a plane section, such as a kite, it will rise because of the wind beneath it. Airplane wings may be compared to a kite, the propeller thrust or tractor screw pull can be likened to the tension of the kite string when one runs along the ground to raise the kite.

#### WHY THE AIRPLANE IS BEST

One can hardly conceive of a man even of enormous wealth, who would maintain an ocean liner for personal gratification or as a means of obtaining pleasure. It is evident that amusement and recreation could be secured at much less expense by the use of smaller and no less practical craft. This is really the condition that obtains in the field of aeronautics, and before the problem of aerial navigation can be said to have been solved it will be necessary to produce practical creations which will be light, speedy and mechanically reliable. One must look to the heavier-than-air class to find flying machines which give promise of becoming sufficiently practical so as to be within the reach of the average prospective user. The principles underlying the construction of lighter-than-air craft are such that extremely large sized balloons must be built, because the small lifting power obtained by the use of the lighter gases than air is wholly disproportionate to the large dimensions of the gas container.

The most practical flying machine, the airplane, depends upon the correct application of aerodynamical principles. Yet, while flying machines in a large sense may be said to include all devices that have contributed to assist man to fly, besides the use of the gas bag, the only form that has attained success is the airplane. This machine is capable of

movement in any direction, as in a vertical or horizontal plane or any angular component of the two, by the aid of simply controlled members which are easily installed on the machine itself and actuated by the pilot. There are three classes of flying machines. Those that seek to sustain themselves as birds do, by flapping wings, are known as ornithopters. Other types have been built in which a lifting action is secured by aerial screws, but none of these have been devised that have produced results sufficiently great to warrant further development of this type. The third class includes the airplane and is the most practical. There are two retarding forces to be overcome in securing successful mechanical flight, those having to do with gravity and others that are due to wind or air resistance.

#### ATTRACTION OF GRAVITY

We will first concern ourselves with the attraction of gravity. Every mass of matter that is near the earth, if free to move, pursues a straight line toward the center of the earth, and the force by which this motion is produced is called gravity. At the same distance from the center of the earth the gravity of different objects varies as the mass. If a body is not free to move, its tendency to go toward the earth's center causes pressure, and the measurement of this pressure is called the weight of the body. Weight is usually employed as a measure of mass. The more the pressure of a body is towards the earth's center, the greater its weight. The body that is said to be the lightest is one that has the least gravity attraction. The attraction of gravity varies directly as the mass, the greater the mass the greater the force acting to bring it towards the earth's center; the nearer the earth's center the less the attraction. A body 2,000 miles under the earth's surface would be attracted with only half the force that would obtain were it at the surface. It is at the surface of the earth that this force is greatest and at great heights it is less. For example, 4,000 miles above the earth's surface gravity is four times less than it is at the earth's surface. At heights at which it is possible to carry on experiments the variation is very slight and may be regarded as negligible. It will be evident that one

of the most important forces to be overcome in flying machines is the attraction of gravity, and considerable power will have to be utilized for this purpose alone.

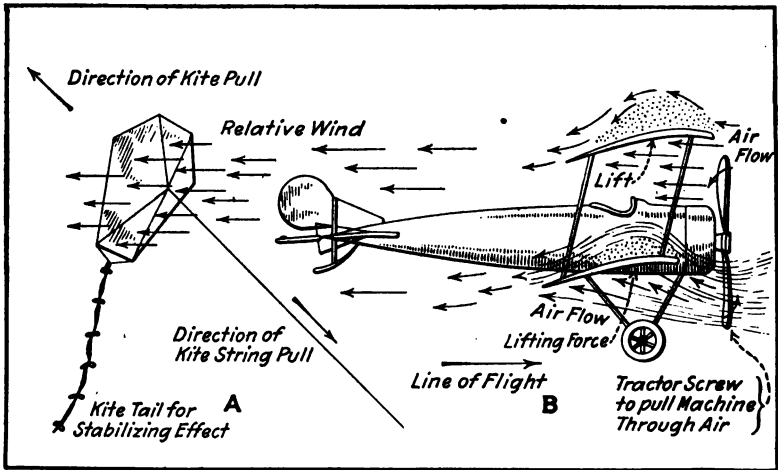
#### ELEMENTARY AIRPLANE PRINCIPLES

In order to secure a good understanding of airplane operating principles it may be well to mention that airplanes of the present day are really developments of the box kite, and that comparisons can be made with well-known appliances such as the sails of boats, to make clear some of the principles upon which airplane flight is based. For simplicity of presentation we can consider the boat sail as an example to show the propelling force of the atmosphere in motion which, as outlined in the first installment, is termed wind. Any object which can be tensed or tightly drawn so that the wind will exert pressure upon its broadest area will create power in proportion to the velocity of the wind and the area exposed to the air pressure. This, of course, means that the object or plane must be at approximately right angles to the relative wind, which is not true of the lifting surface of an airplane, which is inclined at angles ranging from 2 to 14 or 15 degrees as a maximum with the relative wind. Perhaps the most familiar illustration of wind power is the wind-mill, and the toy pinwheel is a device by which any child is capable of unconsciously observing that air in motion will create power or do work.

#### KITE SUPPORTED BY AIR IN MOTION

With the kite attached to the ground by a string and depending upon the velocity of the wind under its surface to elevate it, and a balancing device in the form of a tail to maintain steadiness, as shown at Fig. 4 A, we have one example of the use of air pressure to sustain weight. In the boat sail, which is capable of overcoming the resistance of the water on the hull by using the wind as a propulsive force, we have another example of how the wind may be made to do work, while in the airplane we have to a certain extent the principle of a box kite as far as its capacity for sustaining weight is

concerned by air pressure. Instead of being dependent upon the velocity of the wind as a kite is, an airplane is driven against the air by means of one or more aerial screws which are revolved by suitable prime movers, usually an internal combustion engine as shown in Fig. 4 B. This propulsive force is utilized for a twofold purpose. In the first place, to permit the direction of motion of the airplane to be independent of the wind direction and also to retain a sustaining



**Fig. 4. Diagrams Comparing Action of Wind on Kite and Air Pressure Under Airplane Wings.**

force under the planes regardless of the direction of atmospheric flow.

It will be apparent upon reflection that if the kite is considered a reversed boat sail and then when again reversed an instance or illustration of the airplane supporting surface, it will be evident that in the three there is but one principle, though it is differently applied. In the same manner in which varying power may be secured by altering the pressure of the atmosphere on the sail of the vessel by changing its position, it will be seen that varying the angle of the plane in the air that it is possible to vary the degree of sustaining effort. It is apparent that airplanes must be proportioned with a view of having minimum resistance to the wind, and it must reach

this result without sacrifice of lifting effect or sustaining power.

AIR RESISTANCE

The factor of air resistance is a very important one which must be given careful consideration by the designer of aerial

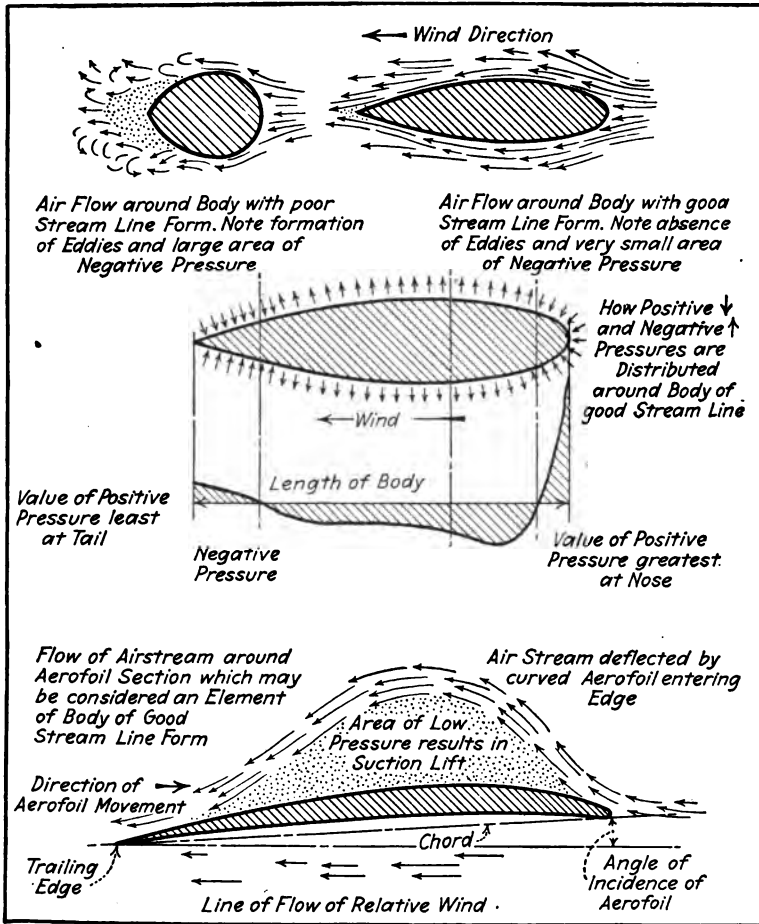


Fig. 5. Diagrams Showing Air Flow Around Various Bodies and Positive and Negative Pressures Produced by Air Currents.

craft. It is of considerably greater moment than one would assume on first thought. The shape of the object being forced through the air (or, in fact, any other gas or fluid) will have

material bearing upon the resistance offered to its passage. A "streamline" body has the least resistance. Air resistance has been estimated to increase as the square of the velocity, so it will be seen that at ten miles per hour atmospheric resistance is four times what it was at five miles per hour; at 50 miles per hour, which is ten times the speed of five miles, the air resistance will be a hundred times as great. It has been found that air currents moving at the rate of 60 miles per hour have a pressure of approximately 17.7 pounds to the square foot, and from this basis the indication of almost any speed may be determined with reasonable accuracy. As an example of the ratio of increase of resistance with augmenting velocity, the following table, which gives the effort required in the horse-power to move a body through the air for each square foot of surface exposed at right angles to the relative wind, will prove of interest. In this case it is well to know that the horse-power required increases as the cube of the velocity, whereas air resistance augments as the square of the velocity.

TABLE I

Miles per Hour	Feet per Second	H.P. per Sq. Ft.
10	14.7	0.013
15	22	0.044
20	24.6	0.105
25	36.7	0.205
30	44	0.354
40	58.7	0.84
50	73.3	1.64
60	87.9	2.83
80	117.3	6.72
100	146.6	13.12

## RESISTANCE OF AEROFOIL SECTIONS

The resistance of plane or aerofoil sections is not nearly as great as that of spherical, cylindrical or rectangular bodies. To begin with, the planes are usually inclined at small angles to the relative wind, and never at an angle of more than 16 degrees, because in the ordinary aerofoil when this point is reached the lift becomes greatly reduced. As the plane

progresses through space with sufficient velocity to obtain a sustaining influence due to the air beneath it, it is thus able to overcome the attraction of gravity. In this connection it is well to state that the lift on the ordinary airplane wing section is not due solely to air pressure on the lower surface of the aerofoil, but, on the other hand, a study of the diagram at Fig. 5 will indicate that there is a pronounced suction effect acting at the top, because there is an area of reduced or negative air pressure which, of course, contributes materially to the total lifting effect. It is stated that this area and the attending lifting influence will vary with the shape of the aerofoil, and that this will also depend upon the aspect ratio of the plane, the angle of incidence and the velocity with which it is passing through the air. To lift the plane, therefore, we must have both compression under the bottom surface and partial vacuum at a portion of the top surface, the direct pressure produced by the former and the increase of lift produced by the yielding of the other raise in ratio with velocity of the air. It is apparent that the movement of the air or velocity of the wind must be sufficient to cause a partial vacuum above and compression below to secure mechanical flight. The following tabulation will give the wind pressure per square foot at the different velocities:

TABLE II  
WIND PRESSURE AT VARIOUS VELOCITIES

Feet per Second	Velocity Feet per Min.	Miles per Hour	Pressure per Sq. Foot
1.47	88	1	.005
7.33	440	5	.123
14.67	880	10	.492
36.6	2200	25	3.075
73.3	4400	50	12.3
102.7	6160	70	24.103
146.6	8800	100	49.2

The figures given above have been determined by considering the pressure of the wind upon a fixed object, but there is probability that there would be some departure from these



values in the event of an object being driven at the speeds indicated against the atmosphere. The table is, therefore, of value only inasmuch as it shows that with the increase in velocity there is a great increase in pressure, which obviously can be taken to mean that there would be a greater sustaining force when the plane is placed at its most advantageous angle of inclination with the relative wind, because it is at this point that the greatest lifting effort will be secured with a minimum of resistance.

The effect of the strength of wind at higher velocities is well known and can be easily understood by any one who has flown a kite. On a windy day there was a much greater pull upon the string than when the movement of the air was less and, unless a favoring air current was found, it was almost impossible to keep the kite in the air unless one exerted a pronounced pressure under the kite by running along the ground in order to draw it through the air by means of the restraining cord. In still air the kite will not raise itself from the ground, and it will fall as soon as the wind produced by drawing it through the air stops. It will be evident therefore, that if one or more surfaces of the usual aerofoil section are attached to a frame that is capable of sustaining a motor for the purpose of driving the apparatus forward by means of fan wheels or aerial screws, and if the surface curvature and area are sufficient to displace the air to an extent capable of exerting a vertical component reaction called lift, which must be greater than the entire weight of the apparatus, we have contrived an airplane which will be capable of flight. The amount of power required depends upon many factors, and as a general rule the greater the surface of the airplane the less the speed that is necessary to drive it through the air to secure sustentation and the less the amount of power required to lift it from the ground.

#### HOW AIRPLANES DIFFER

For this reason airplanes designed to carry loads usually have a large surface, moderate power and relatively slow speed. High-speed airplanes have small surface and high-

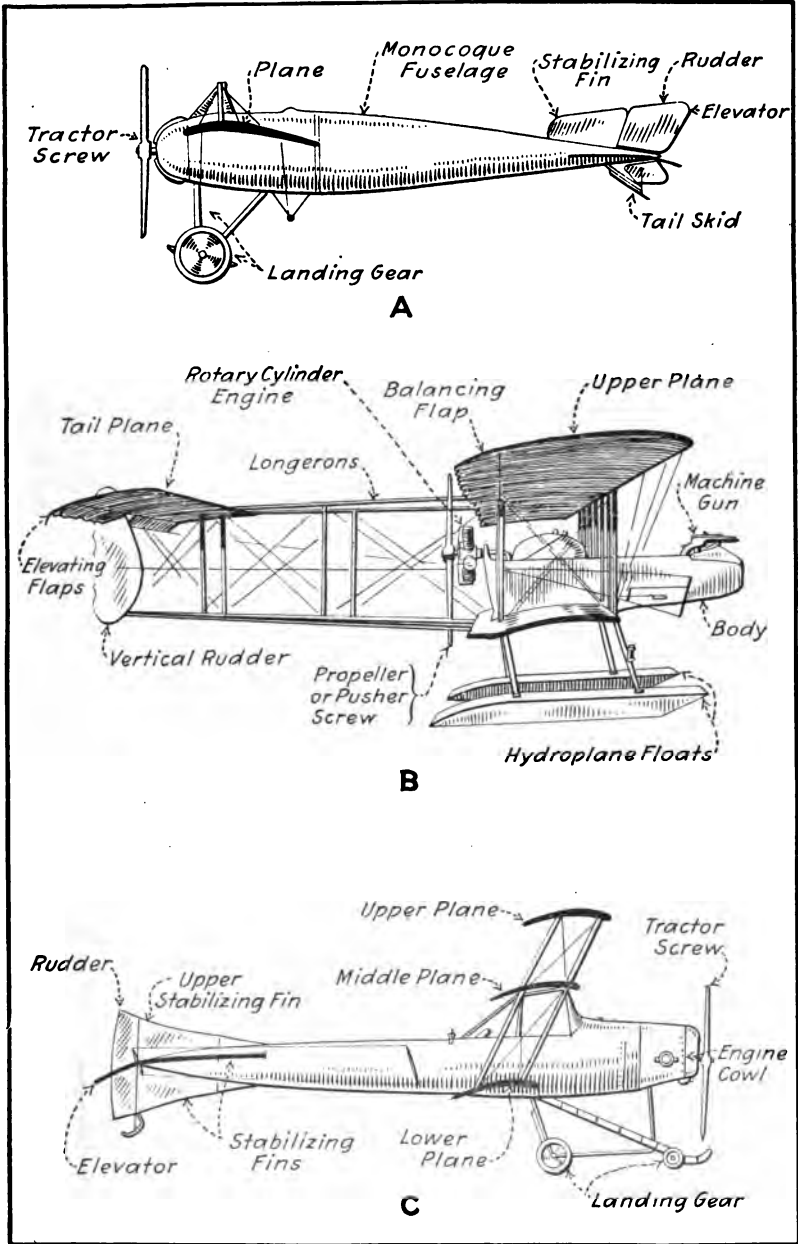


Fig. 6. Three Main Types of Airplanes. A. Monoplane. B. Biplane. C. Triplane.

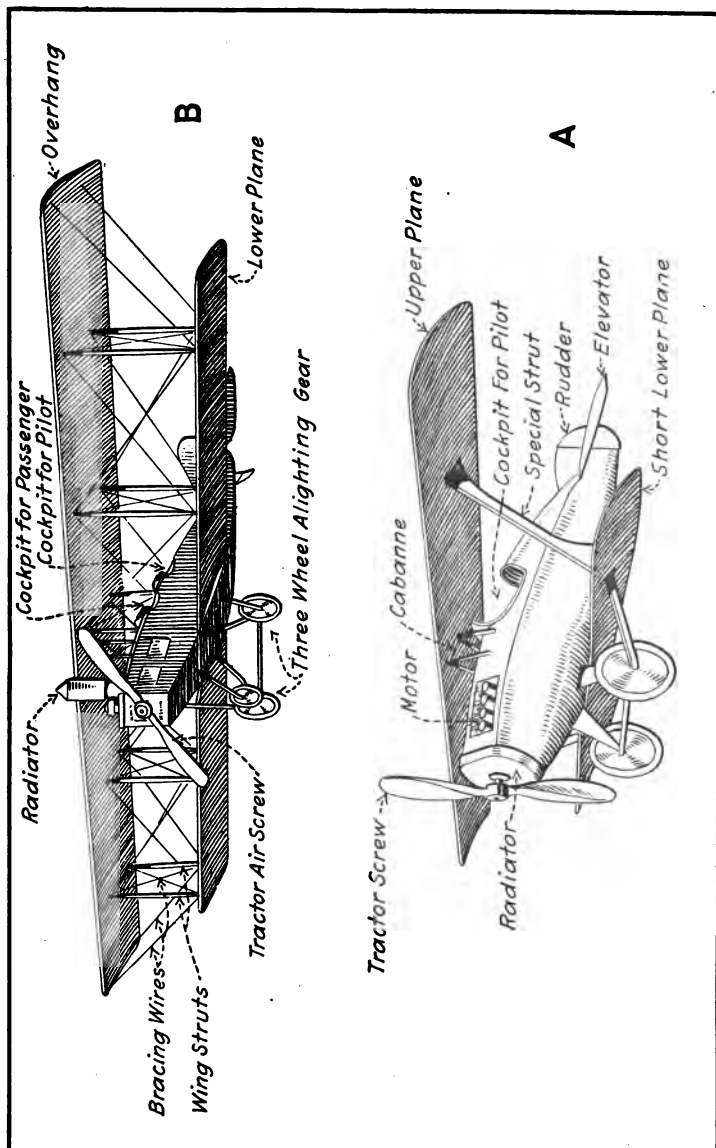


Fig. 7. How Biplane Designs Differ According to Work Required. One Is a Small Surface, High-Speed, One-Passenger Pursuit Model. The Other, a Large Surface, Medium-Speed, Two-Passenger Training Tractor.

capacity power plants. Airplanes are made in three main types—the monoplane as shown at Fig. 6 *A*, the biplane outlined at *B*, and the triplane as depicted at *C*. If the machine has the air screw mounted in front, it is called a tractor; if the power plant and screw are mounted in the rear of the pilot as at *B*, it is called a pusher. Machines intended to rise from and land on water are called “seaplanes” or hydroaeroplanes and are provided with floats instead of wheels. The pusher biplane shown at Fig. 6 *B* is provided with floats instead of wheels. The appearance of a fast one-place scouting or fighting plane is shown at *A*, Fig. 7. The conventional two-seater used in this country for training purposes is shown at *B*. The former is capable of a speed of 120 miles per hour, the latter will not fly faster than 80 miles per hour.

## CHAPTER II

### LIGHTER-THAN-AIR CRAFT

**Spherical Balloon Parts—Hydrogen Gas for Military Balloons—Control of Free Balloons—Free or Captive Spherical Balloons of Little Value in Military Work—Kite Balloons Best for Observation Work—Dirigible Balloon Types—The Zeppelin—Dirigible Balloon Types—The Blimp.**

THE reason why aircraft of the lighter-than-air type leave the ground is a simple one. It is known that there are a number of gases which are lighter than air, *e.g.*, coal gas and hydrogen. The amount of lift possible depends upon the "buoyancy" of the gas, which is the difference between its weight and the weight of an equal volume of air. If one has an understanding of the approximate buoyancy of the gas used as a lifting medium, it is very easy to compute the lifting power of a given quantity of this gas. A balloon with a capacity of 16,000 cu. ft. of hydrogen, if it is filled at the sea level and at a temperature of 60 degrees Fahrenheit, will lift about 1,000 pounds. This, of course, including the weight of the gas and the container; and a balloon capable of lifting 1,000 pounds would of itself weigh about 550 pounds; this means that the envelope or container, the net-work, the observation car and the equipment it carries, as well as the weight of the gas, are all considered. The lifting power of a balloon of the same size filled with coal gas would be no more than 600 pounds. It will be evident that to lift a given weight with coal gas that it will be necessary to use a container holding nearly twice the quantity that is needed to handle the same load with hydrogen gas.

#### SPHERICAL BALLOON PARTS

The parts of a spherical balloon are clearly shown at Fig. 8, and may be readily understood. At the top of the main container, which is made of some fabric chemically treated to prevent leakage of gas, is placed an escape valve which is kept

seated by pressure of the gas from the inside, and which can be opened only by pulling a cord convenient to the aeronaut who is in the basket. The function of this valve is to permit of a certain degree of gas escapement, which can be controlled by the operator when it is desired to descend. As soon as the operator ceases to exert pressure on the valve cord, the valve

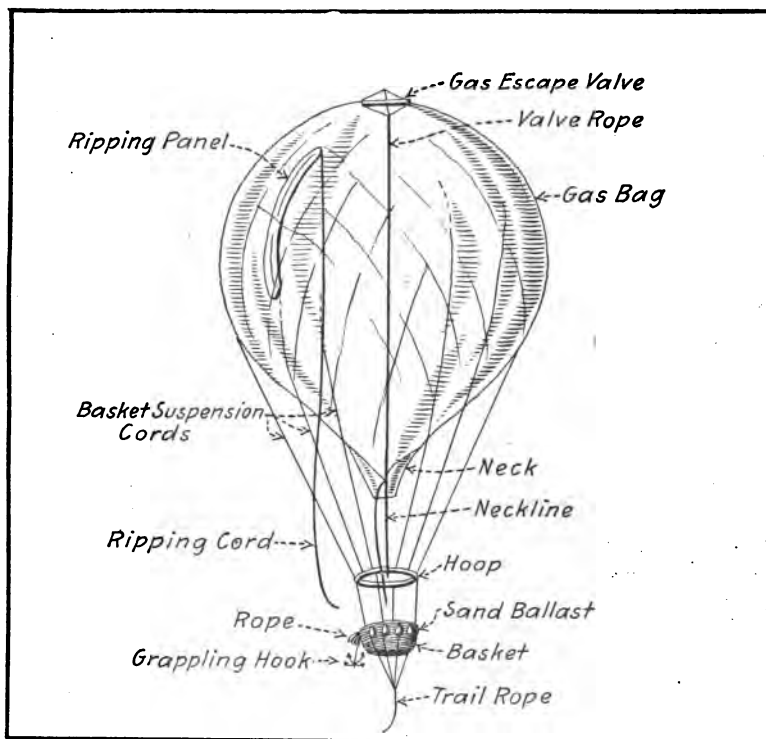


Fig. 8. Simple Free Balloon of the Spherical Type with Parts Designated.

closes and prevents further escape of gas. It will be evident that when it is desired to descend from any altitude, that a decrease in the lifting power of the gas bag would permit it to settle to the ground. There is an open neck at the bottom of the gas bag to permit the gas to escape when it expands, as it would do when coming into warm sunshine. The heat produces an expansion and increases the volume of the gas. It will be apparent that unless some means were taken for relieving

this excessive pressure, that it might disrupt the gas bag; therefore, as the gas expands it rushes out of the gas bag through the open neck at the bottom. If for any reason the sun should be obscured by clouds or there should be considerable moisture in the air, the cooling of the gas will result in its contraction, and there should be a corresponding reduction in volume; the lifting power of the balloon is therefore impaired, inasmuch as the lifting ability is the ratio between the weight of the gas carried and the amount of air that it displaces. In order to keep the balloon from falling too rapidly, and to offset this condensation of the supporting gas, it is necessary for the aeronaut to throw off ballast usually carried in the form of sand, until a state of equilibrium is reached and under which conditions the balloon will stay up as the decreased weight carried is proportionate to the lifting power.

When it is desired to make a rapid descent in order to avoid an approaching storm, or for any other reason, the escape valve is kept open until the balloon begins to settle, and when it has reached a point near the ground the operator will pull the ripping cord and tear away the ripping panel, which is normally sewed to the bag, in order to provide a large outlet for the sudden escape of gas. A grappling hook is carried to permit of securing an anchorage to any convenient tree or fence, and in addition a drag rope, which may be dropped for 100 feet or so below the car, is provided so that it may be grasped by people on the ground who would assist in bringing the balloon to a stop.

#### HYDROGEN GAS FOR MILITARY BALLOONS

Owing to the high cost of hydrogen gas, balloons that have been used for ordinary observation purposes are filled with coal gas, but in all military ballooning the gas bags are filled from compressed hydrogen tubes. It will take about 5 hours to fill a large balloon with coal gas, whereas when the hydrogen is carried in tubes in which it is held under high pressure, less than one hour suffices to fill the bag. Owing to the ease with which hydrogen may be carried when it is contained in tubes under pressure, it is always considered best for military pur-

poses. Relatively simple hydrogen making plants have been devised which may be carried in the field in the event of the supply of compressed hydrogen tubes giving out.

#### CONTROL OF FREE BALLOONS

It will be noted with a free balloon that there is no movement of the balloon relative to the air, as is true of an airplane or dirigible airship. A balloon must move with the air currents in which it is supported. The only control the aeronaut has over the movements of the balloon is to vary its altitude and attempt to seek air currents or winds flowing in the direction in which he wishes to go. The material ordinarily used for making gas bags is silk, though cotton has been employed. The balloon is surrounded by a netting of cord from which cords used to suspend the basket radiate down to a hoop or spacing member of steel, which keeps them separated by the proper distance and prevents them from getting tangled. The baskets are usually of wicker work. Another use for the drag or controlling rope besides that of providing a convenient means of having people on the ground assist in bringing the balloon to a stop is to preserve equilibrium at low altitudes; when the rope is trailing, a certain portion of its weight is supported by the ground, but as the balloon tends to settle more of the rope will be supported by the ground, in which case we have exactly the same effect as though an amount of ballast equal to the weight of rope dragging on the ground had been thrown out of the basket. This relieves the balloon from some of its burden. Then again, if the balloon should tend to rise, some of the rope will be lifted from the ground and the extra weight will tend to check the ascent of the gas bag.

#### FREE OR CAPTIVE SPHERICAL BALLOONS OF LITTLE VALUE IN MILITARY WORK

Free balloons have no definite value for military purposes because of the uncertainty attending their use; there is no guarantee that a balloon of this nature would reach any desired point when released, inasmuch as its voyage would depend



entirely upon atmospheric conditions. A cold, wet day would produce rapid condensation of the gas, shortening the duration of the flight, whereas the operation on a warm day would be much more satisfactory inasmuch as the time of flight would be greatly extended—then again unfavorable winds might blow the balloon out of its course.

The ordinary form of spherical balloon is of little value as a captive balloon for military observation because of its action when restrained from movement. Reference to the illustration of Fig. 9 will demonstrate clearly why the spherical type is not

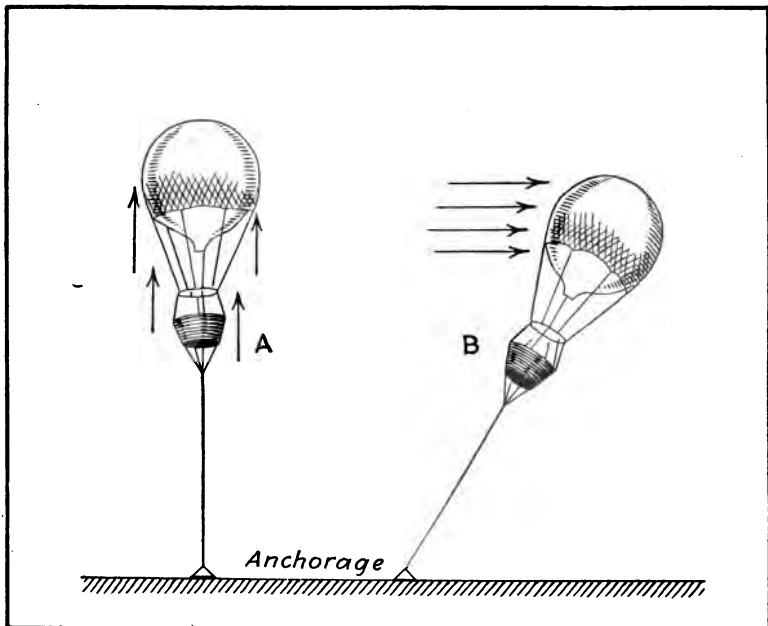


Fig. 9. Why Captive Spherical Balloons Are Not Suited for Observation Work.

the type for military observation purposes under ordinary conditions. If one refers to A in this illustration it will be observed that in an ascending air current the balloon will ride in a position that will readily permit of observations being made; however, should the wind change, and instead of being moderate in velocity assume any speed, it will tend to move the balloon along with it, and the restraining rope, which is

anchored to the ground will, of course, keep the balloon from moving. The result is that the balloon becomes inclined to a degree that makes it very dangerous for the observer, and as it would be swaying violently it would not permit of any observations of value being taken. The condition under which the balloon would work in a wind is shown at *B*.

KITE BALLOONS BEST FOR OBSERVATION WORK

The kite balloon, such as shown at Fig. 10, is the type that is best adapted for captive balloon work. In this balloon, by changing the shape of the gas bag and by the addition of supple-

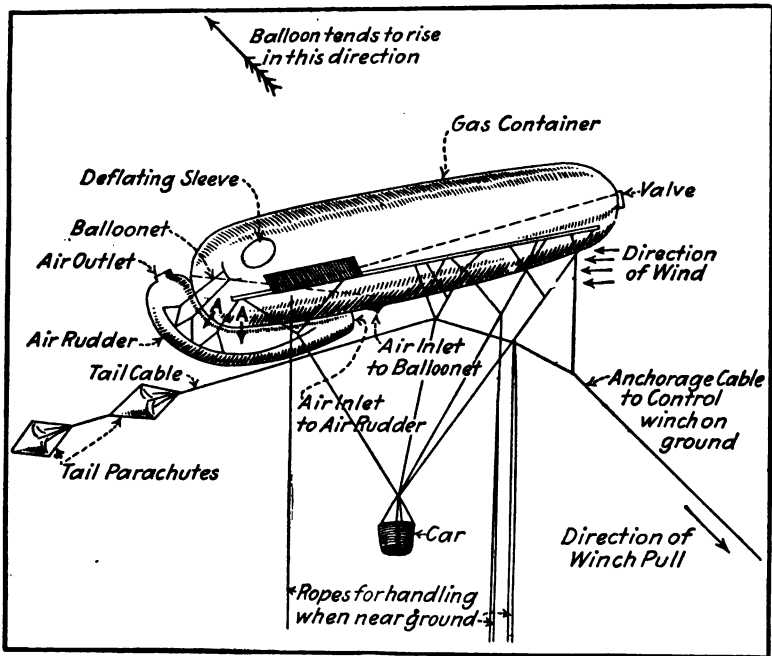


Fig. 10. Parts of Typical Kite Balloon.

mentary tail members, it is possible to have the balloon act just as a kite does, and remain reasonably stable in winds of some magnitude. The construction of a typical kite balloon used for military observation purposes is shown at Fig. 10. This consists of a main bag of gas-retaining material in which a smaller

bag called a "balloonet" is placed. The function of the balloonet is to be filled with air which rushes into the opening and takes care of any expansion or contraction of the gas in the main bag. When the gas in the main bag expands under the influence of the sun's heat, the air in the balloonet can flow out through outlets, as indicated by the small arrows AA, that communicate from the interior of the balloonet to the supplementary air bag or air rudder attached to the bottom of the main gas container. As the air rushes into the opening of this air rudder and passes out of the way it will be apparent that as the velocity of the wind increases its speed through the air rudder bag will increase, and that it will tend to keep the assembly steady, as a tail assists in keeping a kite stable; by the use of a tail cable carrying a number of parachutes or inverted cones, which can fill with air, a further steadying influence is obtained that will keep the balloon from swaying unduly. The pull on the anchorage cable is such as always to keep the balloon in a certain position relative to the air, and as the shape of the container is that of a sausage the air actually assists in keeping the balloon up. Many hundreds of these observation balloons are in use on the battle fronts and form an invaluable method of enabling military observers to gauge the accuracy of fire of the batteries under their control.

#### DIRIGIBLE BALLOON TYPES—THE ZEPPELIN

For offensive purposes the Zeppelin type of airship has received considerable use by the Germans. The Zeppelin airship depends upon numerous independent gas bags ranging in number from 18 to 23, which are held in a lattice work of aluminum metal, so as to form a cylinder with conical ends having from 16 to 20 sides when viewed as a cross-section; each of the gas bags has the usual form of deflating valve and also is provided with an automatic safety valve to permit the escape of gas from the bag if the pressure becomes too high. The capacity of some of the latest Zeppelin types varies from 800,000 to 1,200,000 cu. ft., and the dimensions range from 450 to 550 ft. in length. The diameter varies from 40 to 50 ft. A number of gondolas or cars are attached very close to the

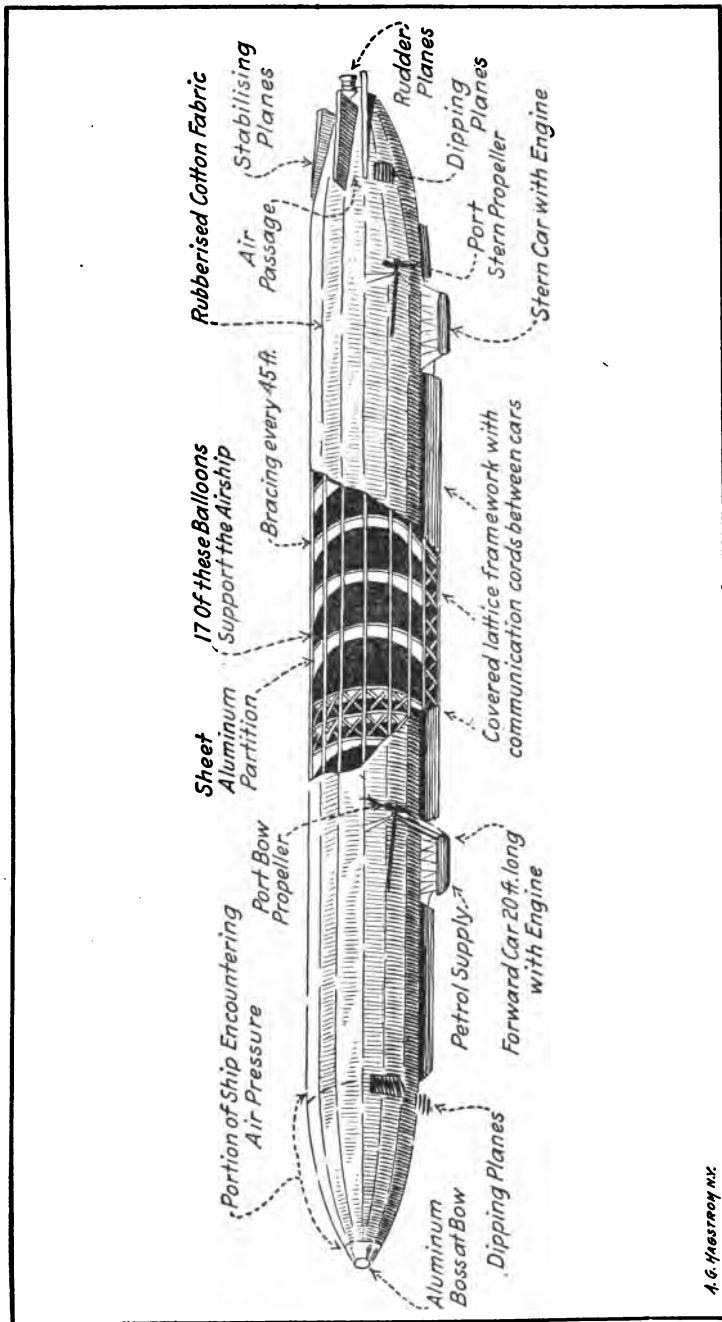


Fig. 11. Part Sectional View of Zeppelin Airship.

framework carrying the gas bags, and have double bottoms and are provided with shock absorbers so that the Zeppelin may descend on both land and water. The rigid type of construction permits of much greater speed than can be secured with the "Blimp" design, because their shape varies to a degree as the pressure inside of the bags varies. The external form of the Zeppelin, which is regulated by the interior framework construction, does not alter its shape. Another thing is that the Zeppelin does not only depend upon the lift of the gas it contains for ascent and descent, but it is provided with horizontal rudders or elevators which can be tilted upwards to give a certain lift when the ship is propelled in a forward direction.

The long under-surface of the airship itself also acts as an elevator as it is driven at high speed through the air. Owing to the small size individual gas bags the Zeppelin airship does not need "balloonets," as the gas expansion is taken care of by the automatic valve. Between the gas chambers and the framework is a space which is filled with non-combustible gas in the war craft in order to serve as some protection from fire. Another thing—this inert gas tends to shield the hydrogen gas to some extent from changes of temperature. These airships are usually provided with water ballast and use several high-powered engines for propulsion. Four propellers are used, these being attached to the framework of the airship and driven from the engines carried in the cars by means of gearing. The Zeppelin is capable of attaining speeds as high as 50 or 60 miles per hour against mild winds, and as it is provided with stabilizing planes and other surfaces that act as elevators to raise or depress the airship, it can be readily controlled. The gas bags are in place inside of the framework; the entire frame assembly is covered with a special fabric which is coated with an aluminum powder compound to increase heat radiation and to reduce the risk of fire. The Zeppelin balloon, however, owing to its large size, is very vulnerable and is much easier to hit with anti-aircraft guns than faster and smaller airplanes are.

**Dirigible Balloon Types—The Blimp.**—The "Blimp" type of balloon is a non-rigid form in which the shape of the gas bag

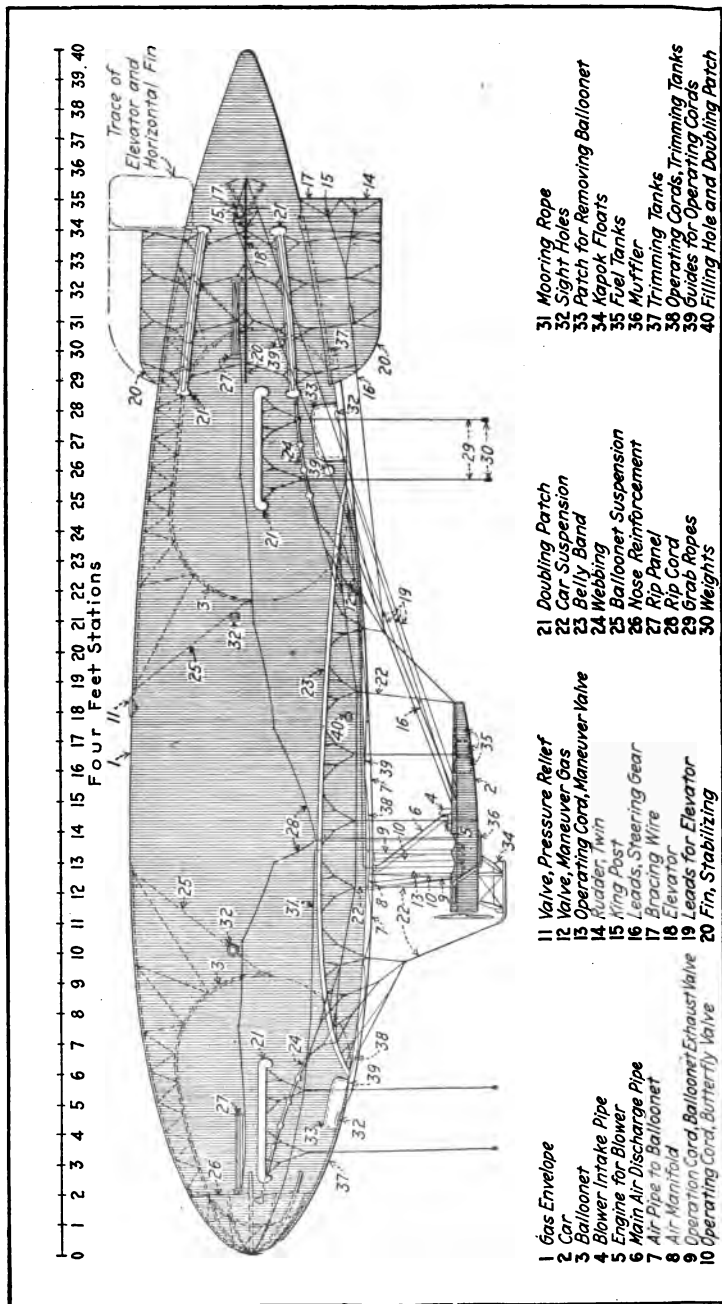


Fig. 12. General Arrangement Plan for New Navy "Blimps."

is maintained by means of an interior balloonet which may be filled with air either from the slip stream of the propeller or by means of a separate blower outfit driven by an auxiliary power plant of the small air-cooled engine form as used for motorcycle propulsion. The amount of air entering the balloonet can be controlled by the operator and, of course, depends entirely upon the condensation or expansion of the gas used inside of the bag as a lifting medium.

A typical "Blimp" is shown at Fig. 12, and this type of aircraft is receiving considerable application for patrolling purposes. It is capable of reasonable speed in the latest types, which are provided with engines of 100 or more horse-power, and is of especial value in hovering over the sea to locate the presence of submarine boats. The usual construction is to use a special cigar-shaped bag, or one with a proper streamline form as will provide for minimum air resistance and ordinary airplane type fuselage, with places for two operators, suspended from the bag by means of the usual suspension wires. These are capable of speeds from 35 to 45 miles per hour and are provided with lifting planes and rudders to facilitate control. Where the lifting planes are used it is not always necessary to change the amount of gas in the container or to throw out ballast to obtain different altitudes. These changes may be obtained by manipulation of the rudders, and as the gas is retained for longer periods it is possible to make longer trips without excessive wastage of gas.

## CHAPTER III

### EARLY AIRPLANES AND GENERAL DESIGN CONSIDERATIONS

**Henson Airplane—Philips Multiplane—Maxim's Flying Machine—Ader's and Other Machines—First Flights of Wright Brothers—Lack of Speed a Draw-back—Plane Forms—Bird and Plane Form Compared—Airplane Moves in Three Planes—Table 3—Birdflight Difficult to Imitate—Comparing Airplane and Bird Flight—Plane Balancing Principles—Airplane Control Methods—Use of Vertical Rudder.**

**Henson Airplane.**—One of the first machines built to operate on airplane principle was devised by an Englishman named Henson, and was built in 1843. This consisted of a light framework of wood, covered with silk, about 100 ft. broad and 30 ft. long and was slightly bent upward at the front. A rudder approximating the shape of the tail of a bird, which was 50 ft. long, was used to steer it in a vertical direction. The car was placed below the main plane and contained the steam power-plant and also provided room for the passengers. Propulsion was to be obtained by two propellers which were placed on either side of the car, and it was proposed to regulate the speed of these. By having the propellers mounted on a universal driving joint it was proposed to assist in turning the machine to the right or left by turning the propellers, so that the thrust would be exerted on an angle instead of in a straight line, as was required to secure normal flight. Owing to very low horse-power and great weight of the power-plant, the engine developing but 20 H.P., the machine was not capable of leaving the ground. Had the modern light-weight high-powered internal combustion engine been available, there is no doubt but that this machine would have been able to leave the ground under its own power, though, of course, in the light of our present knowledge its speed would have been low, its flying action very poor, and it would not have been capable of making any sustained flight.



**Philips Multiplane.**—Horatio Philips, another Englishman, built a very peculiar form of airplane flying machine in 1862. This model had a supporting wing area composed of a very large number of very narrow surfaces with a long advancing edge, the plurality of planes being carried in a frame, so that the entire contrivance resembled a huge Venetian blind. The height of the frame was about 10 ft., the breadth was 21 ft. The whole was mounted on a wheeled carriage shaped like a boat which was about 25 ft. long. It was operated over a circular board track and was anchored by a rope in the middle to the middle of the track. The weight was less than 300 pounds and tests show that a dead weight of 72 pounds placed over the front wheels could be lifted 30 ft. in the air when proper speed had been attained. This proved that airplane surfaces were capable of supporting weight by air reaction. Owing to trouble with the power-plant very little else was done.

**Maxim's Flying Machine.**—A well-known scientist, Sir Hiram Maxim, carried out some very interesting experiments in 1881 with a very large flying machine built on airplane lines, which is said to have cost over \$100,000. This consisted of a large main supporting plane with a number of smaller aerofoils to the right and left of it, the whole having an available supporting area of 3,875 sq. ft. The planes were connected to a platform 40 ft. by 8 ft. by means of a framework built of thin-walled steel tubes, this platform forming the support for the boiler and engine. The diameter of the propellers was over 17 ft. The vertical movement of the machine was controlled by two horizontal planes, one of these being placed at the front of the machine, the other at the back. Horizontal movements were to be controlled by two planes inclined to one another at an angle of about 8 degrees and arranged on either side, so as to be capable of being raised or lowered. The result of this movement was to shift the center of gravity and consequently alter the direction of motion. The entire machine weighed 7,000 pounds, and in the experiments it was mounted on four flanged car wheels and operated on a railroad track. In order to control the upward motion of the machine an overhead rail was placed over the top. With a

steam pressure of 300 pounds (this machine being driven by steam, as it was the only power-plant then available) the machine rose from the lower rails and came into contact with the upper ones. During a test made some time later the upper rail was broken as a result of the impact and the machine flew across a field, and on landing was partially destroyed. This is the first record of a successful flight by a heavier-than-air machine in which the propulsive power was furnished by a power-plant forming a part of the machine structure. The dynamometer test showed that a dead weight of 5,000 pounds would have been lifted, and as can readily be seen, had the modern internal combustion engine been available, it is conceivable that aerial flight might have been solved years earlier than it was. It was about this time that Daimler was perfecting his first crude internal combustion motor, which at that time was not built in multiple-cylinder forms, but only in the simple single-cylinder and two-cylinder V types. These experiments would lead one to believe that it is possible to build airplanes of considerably greater weight than any which have been so successful in modern flying.

**Ader's and Other Machines.**—Among the later creations which must be mentioned is the type shown at the Paris Exposition in 1900, which was devised by a French engineer and electrician named Ader. The planes were of a peculiar form and in the nature of wings which could be folded back. Two propellers were employed, each with 4 blades, and despite the fact that compressed-air motors were utilized to drive the propellers and that the machine weighed over 1,000 pounds, it managed to make short flights and demonstrated that it was capable of lifting its weight from the ground. An Austrian by the name of Kress tried out a machine near Vienna in 1901 with results that gave considerable promise, and the experiments made by the late Professor Langley at Washington, D. C., resulted in the first flight of over a mile by a heavier-than-air craft. This was made by a model plane of his design on December 12, 1896. The experiments of Prof. Lilienthal, a German, who was studying the problem of soaring by means of gliders and the experiments of the Wright Brothers, in this

country, produced real results that were later turned into account in building power propelled airplanes.

#### FIRST FLIGHTS OF WRIGHT BROTHERS

The flights made in 1903 by the Wright Brothers, who built an airplane which was equipped with a motor of their own construction, was really the first development of a type that was at all similar to the machines used at the present time. Even at the early stages of the development they were able to make flights of over 1,000 ft., but owing to the secrecy with which they worked and the isolated points at which their experiments were carried out, but little was thought of their accomplishments by the world at large. Later developments have proved that even at that early date they were far ahead of their contemporaries, because they were working on independent lines and developing new features of construction instead of trying to improve or re-adapt the principles that had been discovered to apply to the very early types of unsuccessful flying machines. It will be understood that in referring to these as successful flights the description is but a relative one, because at that early date any machine that would leave the ground and fly for a few hundred feet at an elevation of 8 or 10 ft. was considered to be a practical flying machine.

#### LACK OF SPEED A DRAWBACK

It required long development and continuous experimenting to develop the modern forms which are capable of making sustained flights for hours at a time at extremely high speeds. One of the difficulties met with in the early types of machines was the provision of power-plants of inadequate capacity. A theoretical consideration by the early engineers working on mechanical flight outlined that flight would be possible with considerably less power than is now utilized, but the machines of that period were very flimsily built and therefore very light and did not fly at very high speeds, so that power-plants of 30 or 40 H.P. were sufficient to handle the requirements of flying under favorable conditions. It was learned later that

reserve power was needed in order to secure flights and to overcome unfavorable atmospheric conditions. In order to secure relative speed it is imperative that the speed of flight be very much greater than any of the winds one would be apt to meet with while flying. A table showing wind force and how it can be measured is appended. It will be evident that if a machine capable of flying at a speed of 45 miles per hour encountered a wind of equal speed and dashed into it, that the machine would remain practically stationary relative to the ground and would not advance. A machine with a high flying speed which calls for considerably more flying speed than was provided at that time would, of course, be able to make progress against such a wind.

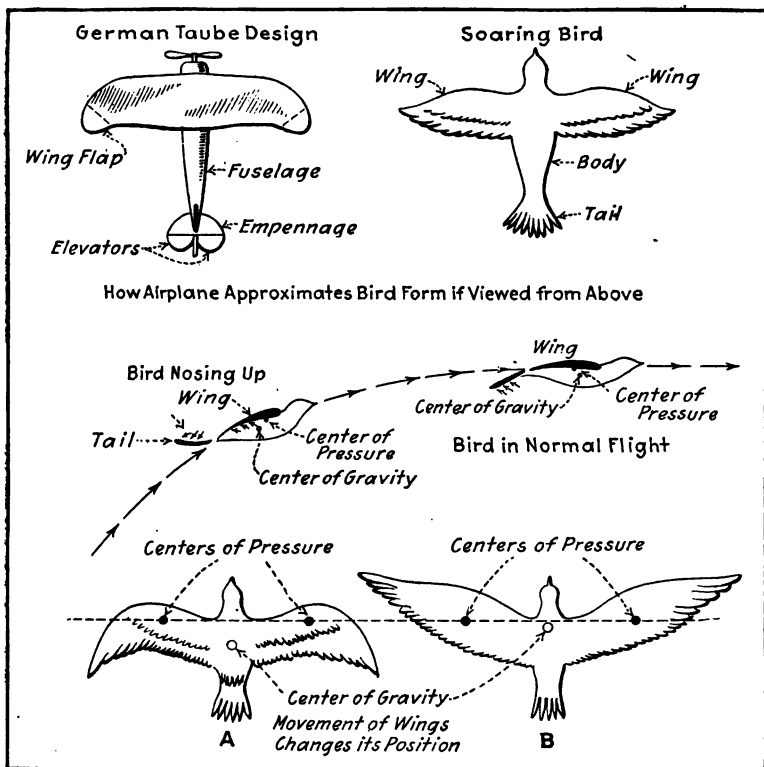
#### PLANE FORMS

The effect of using wings or planes of the same area but of varying shapes and forms is marked, and also with those of different aspect ratio and aerofoil section, but in tests the actual results obtained were so much different as to be the cause of considerable comment. There is no question but that the form of the wing of a bird when extended in soaring flight has proportions which can be followed to advantage by the designer of airplanes; however, the curves of a bird's wings are not easily duplicated in man-made machines, so that various forms of aerofoils have been devised that give really good results when driven through the air at sufficient speed by the thrust or push of a propeller. Experiments have demonstrated that within certain limits the supporting wings should be long when viewed from the front, and short when seen from the side. The best proportions have never been definitely determined and vary in many of the successful creations. The usual aspect ratio is about 6 or 7 to 1,—that is, the spread of the wing from tip to tip is 6 or 7 times the depth or width, measured along the chord.

Professor Langley made some interesting tests to demonstrate that a plane having a wide advancing edge was the most efficient. These, of course, were made with small models. A plane with a width of 6 in. and a length of 18 in. moving

at the rate of 45 miles per hour fell vertically 4 ft. in  $\frac{7}{10}$  of a second. The same plane, when the advancing edge was 18 in. and the length was 6 in., has the same supporting area as the other and when moving at the same velocity it fell vertically 4 ft. in two seconds, demonstrating beyond a doubt that the sustaining power of the form having the wide advancing edge was about three times that of the same plane when it advanced with the narrow edge first.

**Bird and Plane Form Compared.**—If one compares the form of a bird with that of some of the late airplanes, as at



**Fig. 13. A Bird Can Shift the Relation of Pressure and Gravity by Wing and Tail Movements and Secure Changes of Direction in a Vertical Plane with Ease.**

Fig. 13, it will be apparent that they are somewhat similar in form, because both have a wide advancing edge or wing spread

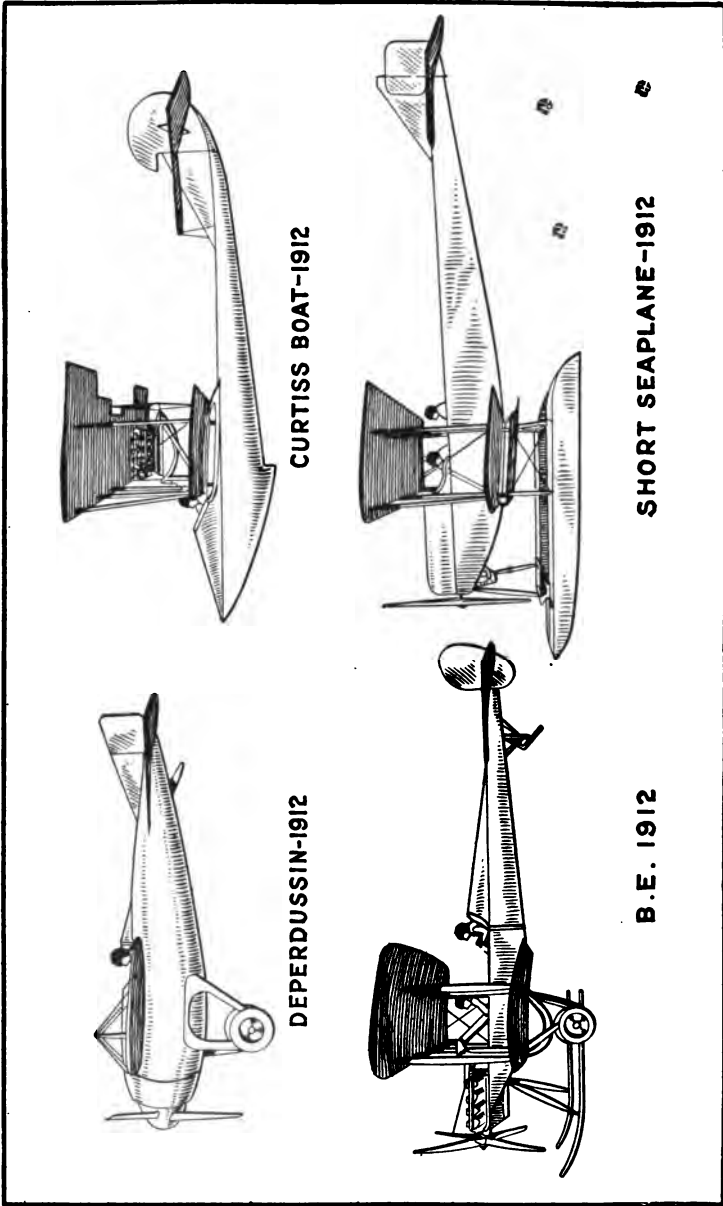


Fig. 14. Successful Airplanes and Seaplanes of Early Development that Suggested Modern Designs.

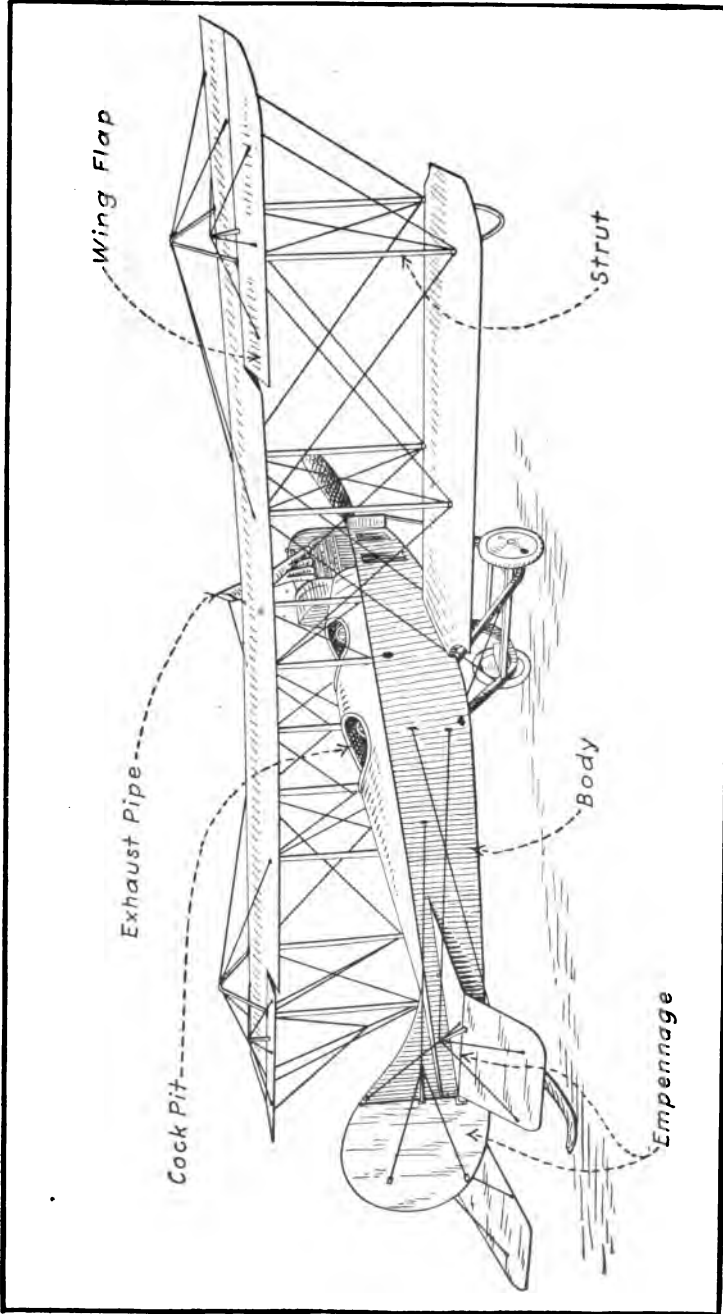


Fig. 15. The Wing Flaps Aid in the Control of Lateral Balance.

and that the plane or wing is comparatively short, and, as will be evident, the bird can utilize its tail as an auxiliary wing which aids and directs its flight. Corresponding to that it is necessary to provide some form of rudder or auxiliary plane on an airplane in the form of an aerofoil which can be lifted or depressed, so that the air will act on the top or bottom of its surface, depending upon the direction it is desired to fly in. The bird has no surface that corresponds to the vertical rudder necessary on an airplane, because it is possible for it

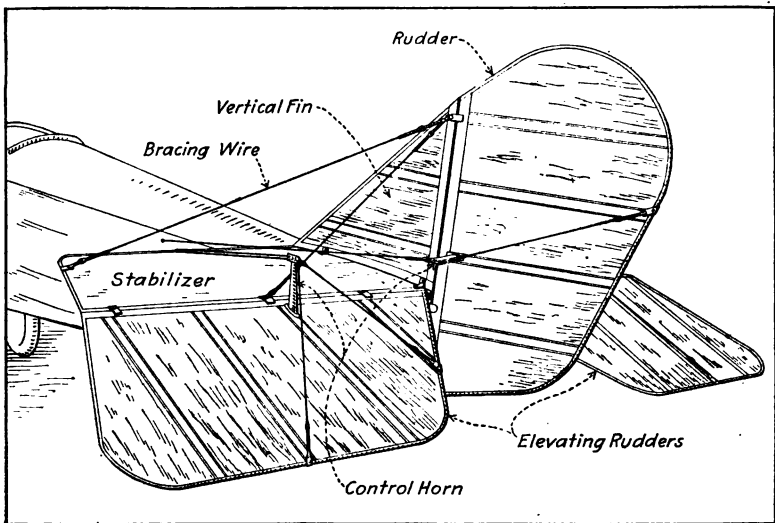


Fig. 16. Typical Empennage of a Modern Flying Machine Showing Various Parts.

to flex its wings and to flap them simultaneously and thus secure propulsive effort and change the direction at the same time. This is not possible with the planes of an airplane which must be immovable relative to the fuselage in order to secure the necessary strength. It is possible, however, to turn an airplane without the use of the vertical rudder by merely working the ailerons which would correspond to some degree to the flexing of the bird's wing tips. The vertical rudder is necessary, however, to make good turns in the man-made machine, even though it can be dispensed with in nature's model.



**Airplane Moves in Three Planes.**—There are really three axes about which an airplane structure can operate, so that three distinct sets of control surfaces are required. In the usual tractor biplane form all of the control planes are at the rear of the fuselage and wings. Those at the tail are called the "empennage." The elevator, which consists of two flaps capable of moving up and down, is at the extreme rear of the fuselage and controls "pitching" or up-and-down movements. The rudder, which has a vertical surface, is utilized for the turning or "yawing," as it is called. The balancing or "rolling" control, as it is called, is produced by the ailerons or wing flaps. The main control surfaces are clearly shown at Fig. 15 in their proper relation to the rest of the machine, and a view of a typical empennage is shown at Fig. 16. This will be considered more in detail in a later chapter.

#### BIRDFLIGHT DIFFICULT TO IMITATE

When one compares the flight of birds with the principles that underlie the support of an airplane in the air, this is not really true, because a part of the supporting force through which a bird flies is obtained by the flapping of wings, which so far has not been successfully imitated by man-made mechanism. It is not strictly a flapping movement, but one that combines a flapping with a forward thrust. Another thing that can never be imitated is the peculiar co-ordination of the various body parts by which a bird can change its center of gravity in its relation to the center of pressure and secure up or down flight by movement of its head, tail or wings. A comparison between birds and airplanes can only be made when one considers soaring birds and then only as long as it supports itself by changing the relation of its wings and body so as to secure the support it needs from varying air currents,—obviously as soon as the bird starts flapping its wings it ceases to act in the same way as an airplane, which cannot have any relative movement of its supporting surfaces or shift weights so that changes of the center of gravity may be obtained.

**Comparing Airplane and Bird Flight.**—In an airplane, the fuselage is suspended between wings on each side which may

be single, in pairs or in triplicate, depending on whether the machine is a monoplane, biplane or triplane. The principle of the wide advancing edge is made use of—just the same as

TABLE III  
WIND  
From Beaufort Scale of Wind Force

General Description of Wind	Specification of Beaufort Scale For Use on Land Based on Observations Made at Land Stations	MEAN WIND FORCE AT STANDARD DENSITY		Equivalent Velocity in Miles per Hour
		Mb.	Lbs. per Sq. Ft.	
Calm . . . . .	Calm; smoke rises vertically . . . . .	.00	.00	0
Light air . . . . .	Direction of wind shown by smoke drift, but not by wind vanes . . . . .	.01	.01	2
Slight breeze . . . . .	Wind felt on face; leaves rustle; ordinary vane moved by wind . . . . .	.04	.08	5
Gentle breeze . . . . .	Leaves and small twigs in constant motion; wind extends light flag . . . . .	.13	.28	10
Moderate breeze . . . . .	Raises dust and loose paper; small branches are moved . . . . .	.32	.67	15
Fresh breeze . . . . .	Small trees in leaf begin to sway; crested wavelets form on inland waters . . . . .	.62	1.31	21
Strong breeze . . . . .	Large branches in motion; whistling heard in telegraph wires; umbrellas used with difficulty . . . . .	1.1	2.3	27
High wind . . . . .	Whole trees in motion; inconvenience felt when walking against wind . . . . .	1.7	3.6	35
Gale . . . . .	Breaks twigs off trees; generally impedes progress . . . . .	2.6	5.4	42
Strong gale . . . . .	Slight structural damage occurs (chimney pots and slates removed) . . . . .	3.7	7.7	50
Whole gale . . . . .	Seldom experienced inland; trees uprooted; considerable structural damage occurs . . . . .	5.0	10.5	59
Storm . . . . .	Very rarely experienced; accompanied by widespread damage . . . . .	6.7	14.0	68
Hurricane . . . . .		8.1	Above 17.0	Above 75

obtained in nature's creation. In a bird, which is always a strictly monoplane design, the body is sustained between two wings that have sufficient supporting area to perform the

necessary functions during soaring flight, but the control of this is so delicate that by the simple movement of feathers at the wing tips, not necessarily the movement of the wings or of the body, it is possible to decidedly change the poise or balance of the bird in the air. Of course, the application of such natural force is instinctive with a bird and the utilizing of speed or wind velocity is all performed automatically without materially affecting the progress of the creature. The fact that this instinctive control is not impossible of attainment by man can be shown by the instinctive balancing which obtains when one becomes familiar with bicycle riding—the unconscious movement of the body so easily accomplished by the rider who has had considerable experience, is very difficult for the novice to acquire, and even after several years' rest it is possible for one who is familiar with bicycle riding or who has learned it to get on a machine and ride off without any trouble.

Of course the mass of a modern airplane is too great to be affected by any unconscious movement of the operator, though this principle of leaning the body to secure equilibrium was used in early soaring gliders and also in the old control system of Curtiss machines, where a shoulder rest which could be rocked from side to side was connected to the ailerons or balancing flaps. The new system of control, however, does not utilize movements of the entire body, though an inherent sense of equilibrium is absolutely necessary in order that the aviator may tell when his plane is not flying as it should, such as having one wing lower than the other, or climbing at too steep an angle. When high up in the air, there is nothing to compare this to except certain parts of the machine, which practice and observation tells the operator must occupy a certain position when in normal flight. We have seen that a slight angle of inclination is necessary to obtain sustentation with the expenditure of a moderate amount of power and that this angle of inclination is constantly varying, due to the control elements.

**Plane Balancing Principles.**—The balancing of a plane is not difficult to understand if one is familiar with the underlying principles of simple levers. It is known that the smaller the distance the weight to be lifted is from the center of support or

fulcrum of the lever, the smaller the amount of force that is necessary to exert a given power. For example: assume a lever that had its fulcrum located  $\frac{1}{6}$  of the distance from the front end and  $\frac{4}{6}$  from the rear end. If one wished to lift 20 pounds at the short end, it would be necessary to exert but 5 pounds at the longer end of the lever to do this, because the power applied is multiplied by the length of the arm leading to the fulcrum point. An airplane may be considered as a lever having the position of the control surfaces so arranged that the air pressure on the empennage will produce a lift or depression that will cause the machine to rock around its supporting point (which is called the center of gravity) between the wings. The farther away from the center of gravity the control surfaces are, the less their area needs be, conversely; the nearer they are the larger the area must be. This point is briefly touched upon and will be considered more completely in a later chapter.

**Airplane Control Methods.**—The control of the airplane is easily accomplished by the operator by means of the auxiliary surfaces which may be disposed horizontally for controlling movements in a vertical plane, such as the elevator flaps; and disposed vertically for controlling turning to the right or left as is the vertical rudder. Horizontal flaps for balancing are carried at the rear ends of the wings to balance the machine. The manner in which the elevator operates can be readily ascertained by reference to the accompanying illustration (Fig. 17) which shows three positions of a tractor biplane. The normal position at *A* shows the machine flying along the normal line of flight, but the elevator is in a neutral position so that the air pressure is equal at the top and bottom. This, of course, produces no movement up or down of the tail. At *B* the elevator position has been changed so that the air currents lift under the bottom of the elevator; the resulting air pressure reaction lifts the tail of the machine up and causes the front end to nose down. At *C* the position of the elevator is reversed, that is to say, it is inclined in such a way that the air current presses upon its top surface. This produces pressure, which tends to force the tail down and lift the nose of the machine up. The center of gravity of the machine is always

considered the equilibrium point about which the lifting force at the tail acts. By inclining the elevator up or down we are able to lift or depress the tail of the machine and produce a resulting or opposite action at the front end of the machine. For example: if the tail is forced down, the nose will be forced up and the machine will climb. If the tail is forced up the nose will be forced down and the plane will move on a downward

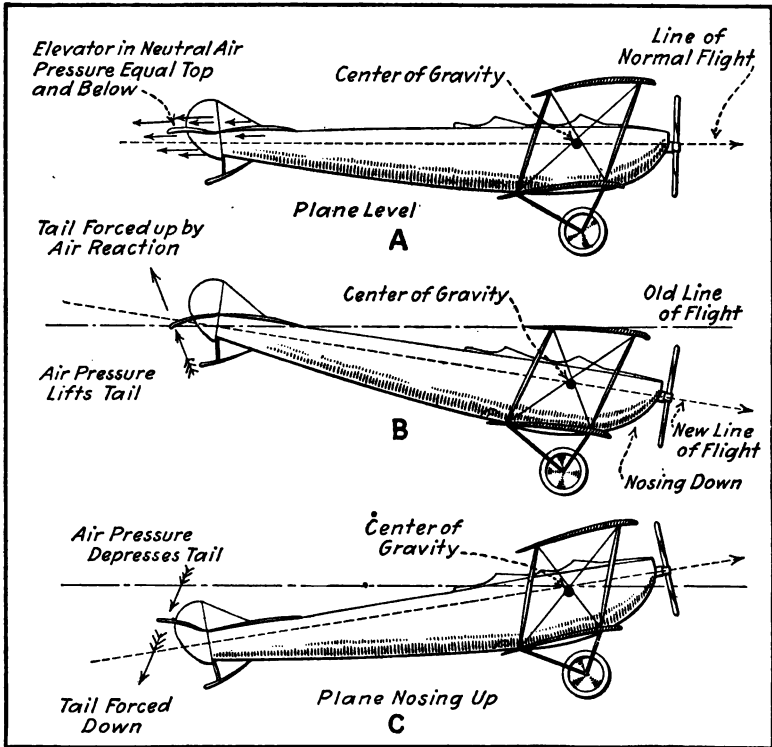


Fig. 17. How the Elevator Controls the Direction of Flight.

path. When the surfaces are left in a neutral position, so that the air pressure is equal at the top or bottom, the plane will fly along the normal line of flight.

**Use of Vertical Rudder.**—The same action that has just been explained in relation to the elevator will work in about the same way when the vertical rudder is tilted to the right or to the left. The reaction of the air against the inclined surface

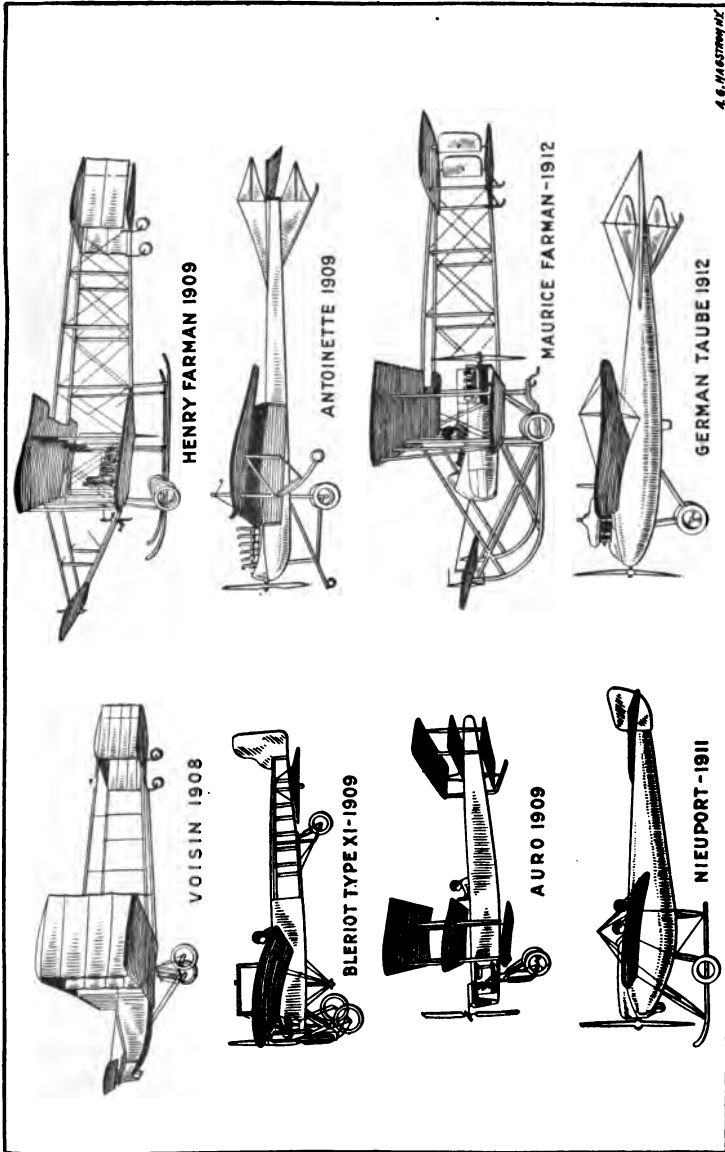
naturally pushes the back end of the machine around in the direction in which the force is acting. In this way it is possible to steer the airplane in the air just as a boat is steered in the water. The remaining control, which is that for balancing the machine or maintaining it in equilibrium, is obtained by the wing flaps which are carried at the rear extremities of the wings in most of the modern machines. (See Fig. 15.) In some of the earlier airplanes the ailerons were held by the struts and were carried at a point approximately midway between the supporting planes. It will be evident that as long as the wing flaps are allowed to remain in a neutral position that there will be no more lift on one wing than on the other. Let us assume that it is possible to raise one wing flap and to lower the one on the other side, as in banking when making a turn. The wing flap or aileron on the side that is to be high is moved so that the pressure will act on its lower surface while the corresponding member of the wing that is to be lowered is moved in such a way that the air pressure acts on its upper surface. The function of the wing flaps or balancing ailerons is not only to permit the operator to right the machine when it is tilted by a gust of wind, but also to tilt the machine purposely when it is desired to bank when the machine leaves a straight path and describes a circle.

## CHAPTER IV

### DESIGN AND CONSTRUCTION OF AEROFOILS

**How Plane Performance may be Gauged—Meaning of Lift and Drift—Lift-Drift Value for Rectangular Plane—Meaning of Center of Pressure—Properties of Cambered Aerofoils—Leading Edge Should be Curved Down—Best Design of Cambered Aerofoil—Table 4—Table 5—Effect of Wing Loading on Aerofoil Design—Wing Sections Vary in Design—Effect of Aerofoil Camber—Effect of Varying Lower Camber—Pressure Distribution on Aerofoils—Position of Maximum Efficiency—Position of Center of Pressure—What is Meant by Critical Angle or Burble Point—Greatest Lift Produced by Upper Surface—Table 6.**

THE reader doubtless wonders how it is possible for an airplane designer to determine the best aerofoil form for a given set of conditions and how it is possible to settle upon a certain cambered surface as the most desirable. The best proportions for supporting surfaces can be obtained by experiments with scale models, which are placed in a wind tunnel and air currents of varying velocities are forced through the tunnel and around the model to stimulate the air stream travel of a machine in flight. If the tests are made with a model of correct proportions the action of much larger bodies of identical proportions can be accurately determined by what is termed the "principle of dynamic similarity." The practical application of this is of great value in both marine architecture and aeronautical engineering. A prediction of the performance to be expected from full size airships may be made after wind-tunnel tests of small models. The wind tunnel is a large rectangular section conduit having a large power-driven blower type fan at one end and incorporating suspension and recording devices by which the action of the model can be observed and measured by the experimenter outside of the tunnel. The blower fan can be driven at different speeds and air currents varied to simulate winds of various velocities.



A. G. Westmeyer

Fig. 18. Some Early Types of Airplanes that Made Successful Flights.



## HOW PLANE PERFORMANCE MAY BE GAUGED

In the cases where the test of a model, which may be either an airplane or any of the parts of which it is composed, is made in the air stream of the same velocity in which the full sized machine or part is to move, the forces upon the small and full sized bodies will be proportional to the square of their corresponding dimensions and also to the square of their relative velocities if the air stream acting on the model is less than the wind pressure that will act on the full sized body. By blowing smoke in the wind tunnel, the actual flow lines of the air around the body may be determined visually and, if photographed, made a matter of permanent record.

## MEANING OF LIFT AND DRIFT

Considering first a flat plane, when this is tipped so it makes an acute angle with the relative wind, it will be subjected to the forces shown at Fig. 19. The vertical force which

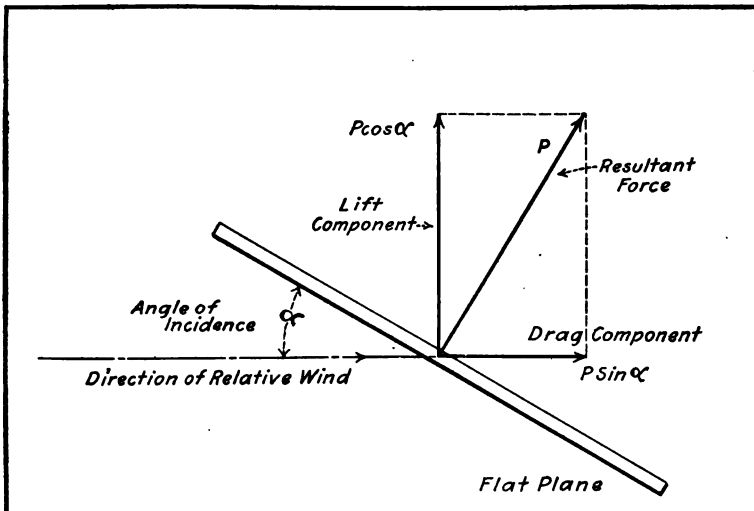


Fig. 19. Diagram Showing Meaning of Lift and Drag, and Forces Represented by These Terms

is  $P$  cosine angle of inclination is called the "lift" component, and the horizontal force, which is indicated as  $P$  sine angle of inclination is termed the "drag" or "drift" and offers a resist-

ance to forward movement of the plane. The pressure  $P$  is a resultant of the two component forces. Obviously, it will be desirable to have the "lift" component greater than the "drift" or "drag" component and the greater the difference between the two, the more effective the lifting ability of the plane becomes, because the lift is increased and the resistance to forward motion or "drift" is reduced. The value of the "lift-drift" ratio for an inclined flat plane will depend upon the inclination and aspect ratio of the plane, the latter not influencing this much above aspect ratios of 8 or 10. Aspect ratio means the relation between the length and breadth of the plane. For instance, a rectangular plane with a length of 20 feet and a breadth of 4 feet would have an aspect ratio of five.

#### LIFT-DRIFT VALUE FOR RECTANGULAR PLANE

The results of a wind tunnel test to determine the lift-drift values for different angles of inclination upon a rectangular

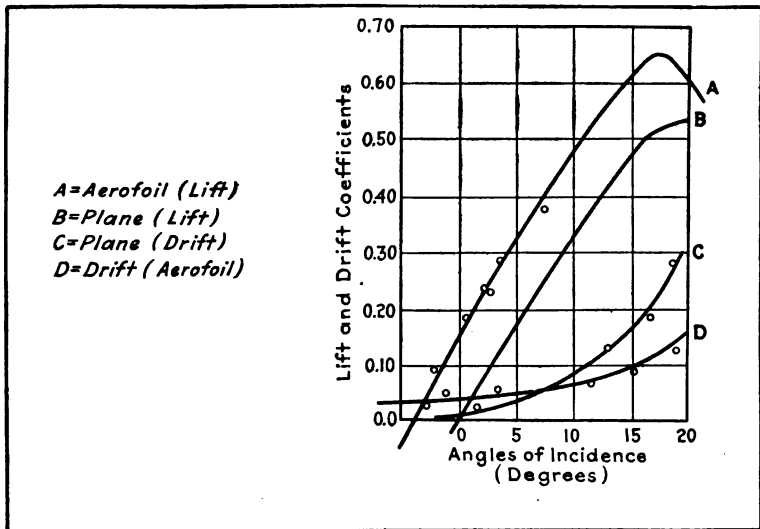


Fig. 20. Diagram Showing Lift and Drift Values for Flat and Cambered Planes.

plane scaling 12.5 inches advancing edge by 2.5 inches chord are shown graphically in Fig. 20. The wind velocity was 20 miles per hour. The lift force follows a linear law of variation

up to an angle of about 15 degrees and the lift reaches its maximum value at about 20 degrees. The "drift" coefficient varies slightly between 0 and 4 degrees, from which point it increases rapidly following a parabolic curve. If these curves are compared with similar values for a cambered aerofoil plotted in the same chart, we find that the lift curve of the aerofoil reaches its maximum at about 16 to 17 degrees angle of incidence, after which the lift falls sharply. This angle is termed the critical angle or "burble point" and is the maximum angle of incidence for the aerofoil in question because any further increase decreases the "lift" and greatly augments the "drift," and as these curves tend to meet, the lifting ability of the aerofoil diminishes.

#### MEANING OF CENTER OF PRESSURE

The "center of pressure" of any aerofoil or body exposed to the wind may be considered as the point where the resultant force shown at Fig. 19 acts. In the case of a flat plane normal

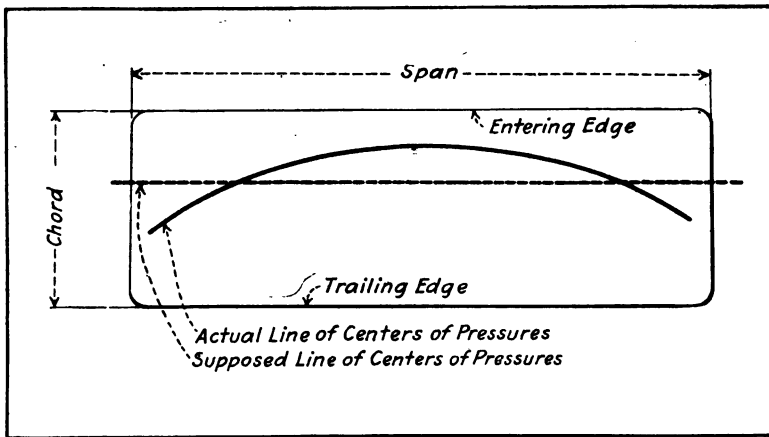


Fig. 21. Location of Centers of Pressure on a Rectangular Aerofoil.

to the wind direction the geometrical center may also be considered the center of pressure. The "center of pressure" position is an important consideration in aerofoil design because the computations for the strength of wing parts are of necessity

based on the position of the center of pressure which represents the load. The initial center of pressure movement is greatest in aerofoils of large aspect ratio, and in flat rectangular aerofoils, the center of pressure will be at the center of the aerofoil at 90 degree inclination. It does not follow, however, that the center of pressures of all the aerofoil sections will be the same distance from the leading edge. In fact the *C.P.* of the central part of the plane is nearer the leading edge, while the *C.P.*'s of the portions near the extremities are nearer the trailing edge. This is clearly shown in Fig. 21. The travel of the center of pressure is greatest for small inclinations, and it is nearest the leading edge where plane is tilted at small angles of incidence. The reason the center of pressure is nearer the trailing edge as it nears the extremities of the plane is because of "end losses." This is caused by the ingress of air at atmosphere pressure into the region of partial vacuum above and also because of the flowing of the air under pressure below the plane into the air not acted upon by the plane movement. This results in a reduction of "lift" and an increase in "drag" for the sections near the wing or plane tips.

**Properties of Cambered Aerofoils.**—While previous consideration has been of flat planes, it is necessary to consider the cambered aerofoils ordinarily used in airplanes as these have properties that make them more suitable for sustentation than flat planes. The wings of birds are really curved or cambered in section and unless there was some advantage in this method of forming wings, it is evident that Nature would have used the simpler flat plane. Both theory and practice indicate that there are marked advantages in having airplane supporting members of cambered section. Comparison of the action of air currents when meeting flat and cambered planes may be made by referring to diagrams at Fig. 22. Considering the flat plane shown at *A*, which is supposed to be dropped vertically, it will be evident that owing to the compression below the plane and the rarefaction of the air above it that there is bound to be a circulation of air from below the plane to the less dense area above it, this giving rise to a kind of vortex motion. Then consider the action of the flat plane

moving in a horizontal direction as shown at *B*. Here, also, we will have a vortex action and the leading edge of the plane will meet air having a relative upward velocity and the leading edge cannot meet the air in the most efficient manner as there will be considerable shock and resistance to forward motion.

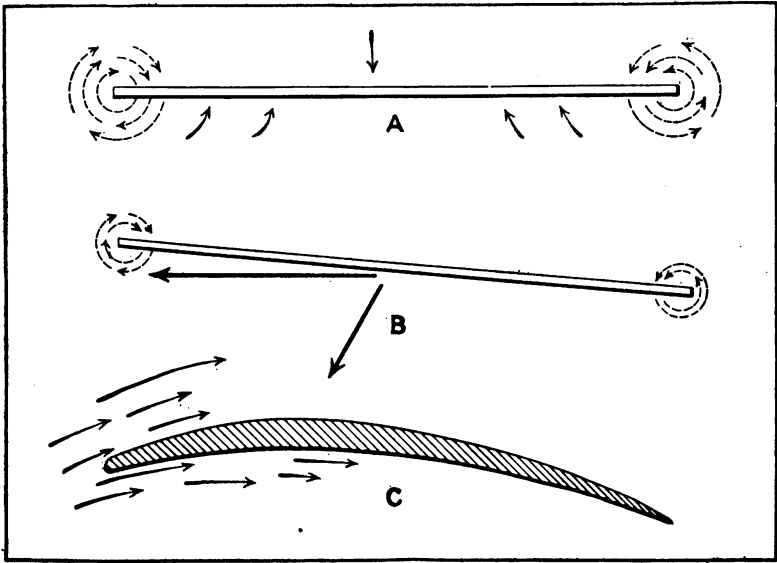


Fig. 22. Diagrams Showing Advantages of Cambered Section Aerofoil.

The "drift" curve is of lower value for a cambered aerofoil than it is for a plane as shown graphically in Fig. 20.

**Leading Edge Should Be Curved Down.**—To meet the air without shock it is important that the leading edge be curved down so it will approximate the direction of the air currents meeting it as shown at Fig. 22 *C*, and the shape of the aerofoil be such that it can be considered as an element of a body of good streamline form. As will be seen by reference to Fig. 23, the air stream travel is such that it is at first upwards, then finally downward, so in the case where the aerofoil is moving horizontally and inclined at a moderate angle of incidence having a low "drag" or "drift" value to retard its forward movement, that a downward momentum will be given to the air streams, this resulting in a vertical lift.

**Best Design of Cambered Aerofoil.**—The air streams flowing over the top of the aerofoil are deflected sharply up-

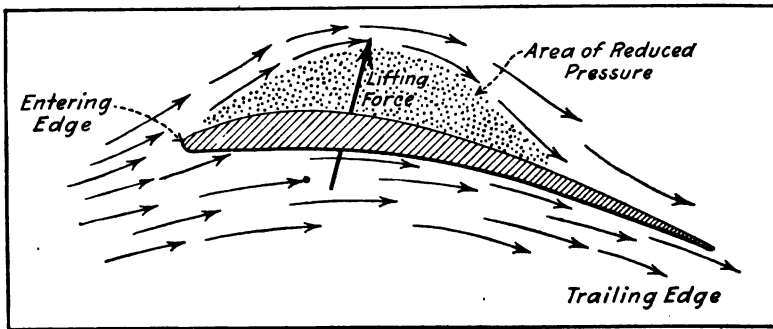


Fig. 23. Diagram Showing How Vertical Lift Is Obtained on Cambered Aerofoil Because of Air Pressure.

wards and as a result, there is an area of reduced pressure above the top camber of the aerofoil which augments the value of the lifting force by reducing the pressure of the air above it

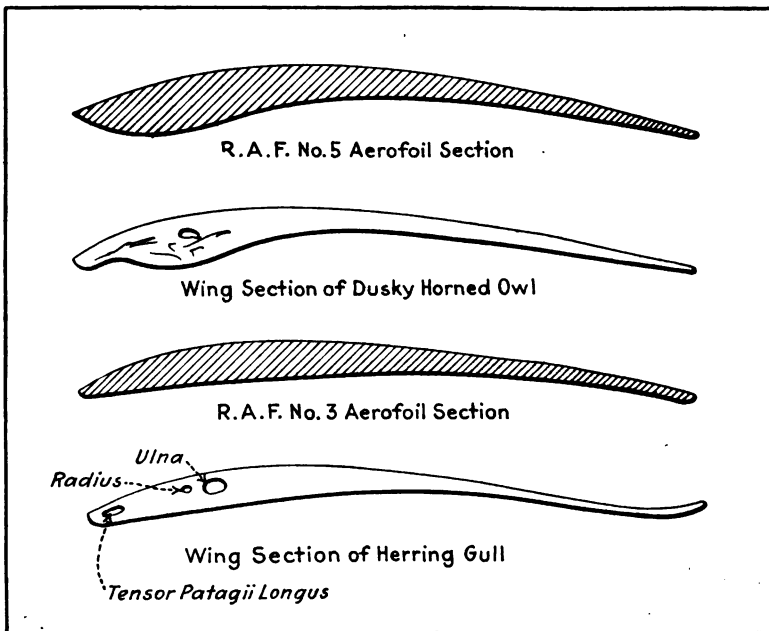
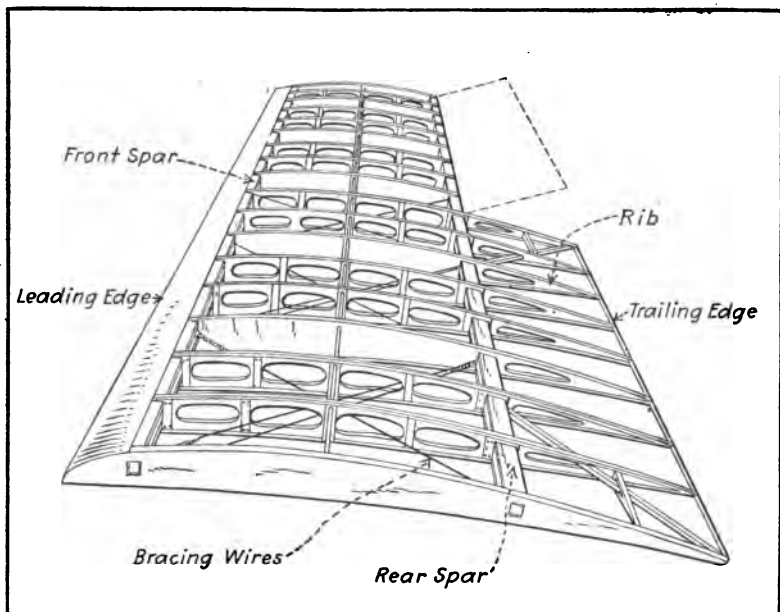


Fig. 24. How Bird's Wing Section Compares With Aerofoil Sections.

and consequently the resistance to the upward movement of the aerofoil. The real advantage of a cambered aerofoil evidently is that it receives a current of air in an upward direction and directs it downward, thus obtaining a lift reaction. The best design of cambered aerofoil would be the form that had the greatest area of negative pressure on top and the greatest value of positive pressure on the bottom and that at



**Fig. 25. Skeleton Structure of Airplane Wing Showing Cambered Ribs Which Give the Aerofoil Its Shape.**

the same time was so formed that there would be no break or eddy in the streamline air flow over its surfaces.

**Loading of Bird's Wings.**—In the preceding chapter mention was made of the similarity in cross-section of some of the aerofoils used for airplane support and the wings of birds. The wing loading of birds, *i.e.*, the amount of weight carried per unit area is light compared to that of flying machines as it varies from half a pound to 2 pounds per square foot. The wings of a black vulture, for instance, are loaded 1.25 pound per square foot. The sustaining members of the dusky

horned owl and the tawny eagle are loaded about 0.90 pounds per square foot. All birds' wing sections are different and undoubtedly have changed in form as a result of a natural development or evolution depending upon the habits of the birds, such as whether they were gliders, soarers, flappers or swimmers.

The student of airplanes may wonder what the proportions of the flying machine devised by nature are and how the supporting surfaces compare in different birds in reference to their weight and flying power. It is conceded that while a study of bird flight and form may be of interest to the student, it is hardly necessary to give this more than passing consideration at the present time. It has been stated that in pre-historic times much larger creatures inhabited this earth than we know of to-day. These included peculiar flying forms that were neither bird, reptile or mammal, but which had characteristics of all of these. Many centuries ago a large flying creature which was a combination of reptile and bird and which was known as the Pterodactyl existed, and while it is not possible to give the exact size of this creature, from the present existing skeletons reconstructed by modern scientists, it is assumed that the wing spread was about 20 feet and that a supporting area of about 25 square feet was available for supporting it in flight. The weight was 30 pounds and it was estimated that it was capable of exerting about  $\frac{1}{25}$  H.P.

If we consider the modern birds, perhaps the largest soaring biped is the condor, which has a wing stretch of 10 ft. from tip to tip, a weight of 17 pounds, a wing area of about 10 sq. ft. and which is capable of exerting about  $\frac{1}{30}$  H.P. The turkey buzzard is a smaller soaring bird which has a wing stretch of 6 ft., a supporting area of 5 sq. ft., a weight of 5 pounds and a power capacity of but little over  $\frac{1}{100}$  H.P. It will be evident that the ratio of supporting surface to the weight of the creatures does not always vary directly with their weight and, strange to say, the larger the creature the less relative power and surface area is needed for its support. The following table, which deals with insects, is given to support this contention. In this, as a basis of comparison, each insect is supposed to be proportioned so that it will weigh 1 pound. Insects fly by



very rapid vibration of their wings and seldom soar. The figures given were published as early as 1868.

TABLE IV  
SQUARE FEET WING AREA PER POUND WEIGHT

Insects	Wing Area
Gnat.....	49.0
Dragon Fly.....	30.0
Bee.....	5.25
Flies.....	5.1
Stag-Beetle.....	3.75
Rhinoceros-Beetle.....	3.14

This table serves to prove the law that the larger the creature the less the relative area of support to a given weight holds true as applies to insects, and as we shall demonstrate by the following table, which has been prepared from data

TABLE V  
VALUE OF NATURE'S AND MAN'S FLYING MACHINES

Birds	Weight in Lbs.	Surface in Sq. Ft.	H. P.	Area per Lb.	H. P. per Lb.	Lbs. per Sq. Ft. of Surface
Humming bird.....	0.015	0.026	0.001	1.73	0.066	....
Pigeon.....	1.00	0.7	0.012	0.7	0.012	....
Wild goose.....	9.00	2.65	0.026	0.2833	0.00288	....
Buzzard.....	5.00	5.3	0.015	1.06	0.003	....
Condor.....	17.00	9.85	0.043	0.57	0.0025	....
Pterodactyl.....	30.00	25.00	0.036	0.833	0.0012	....
<i>Airplanes</i>						
Bleriot XI (early monoplane).....	700.00	150.00	25.00	0.214	0.035	4.7
Wright (early bi-plane).....	1,100.00	538.00	25.00	0.489	0.022	2.04
Curtiss (early bi-plane).....	700.00	258.00	60.00	0.368	0.85	2.7
Standard Model J (modern).....	1,350.00	429.00	100.00	0.318	0.014	3.1
Wright-Martin Model V (modern)....	1,725.00	430.00	150.00	0.24	0.092	4.01
Burgess Type V Seaplane (modern)...	1,800.00	500.00	100.00	0.27	0.55	3.6

NOTE—Airplane weights given without passengers or military loads.

compiled by Langley, which has reference to both soaring birds and those which fly by flapping their wings it will be evident that the law mentioned holds true for large living creatures. Birds, such as the pigeon and goose, seldom soar, and they must keep flapping their wings practically all the time they are in flight. The humming bird flies by moving its wings rapidly so that its flight resembles that of an insect more than it does of a bird. The larger creatures enumerated are soaring birds and it is to these that the aeroplanes should be compared. The figures given are only approximate, but are of interest in showing the proportions obtained in both natural and man-made flying machines.

**Effect of Wing Loading on Aerofoil Design.**—The wing loading of early airplanes was seldom more than 3 pounds per square foot and in the case of the early Wright machine

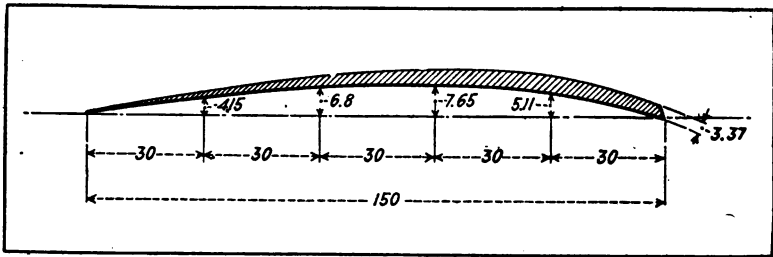


Fig. 26. Aerofoil Section of Early Form Suitable for Light Loading.

it was but little more than 2 pounds per square foot. At the present time wing loading has increased to 5 or 6 pounds per square foot average and in some very high-powered fast airplanes it may run up to 10 or more pounds in rare instances. A wing section to carry a heavy load must be a deep section. The section shown at Fig. 26 gives the approximate proportions of the early Wright aerofoil which was lightly loaded, and its shallowness will be apparent. The diagram at Fig. 27 shows the deeper section needed for structural strength and to accommodate spars of the proper cross-section to withstand the increased load.

It will be evident, therefore, that structural strength, as well as aerodynamical considerations, must be taken into ac-

count in selecting aerofoil sections. The factor of strength must be considered fully as much as efficiency, and if a compromise design must be evolved where one or the other of these qualities must be sacrificed, it is better to favor strength even if the efficiency is somewhat less. Many forms of wing sections have been developed. Some have attained one object, others have properties that make them suitable for other work. There is no one wing section that is the best: Efficient forms devised for speed craft are not suited for slow flying or weight carrying planes. The best aerofoil section to use depends entirely upon the use to which it is to be put. Any fixed aerofoil section is suited to only a limited range of flying angles, and

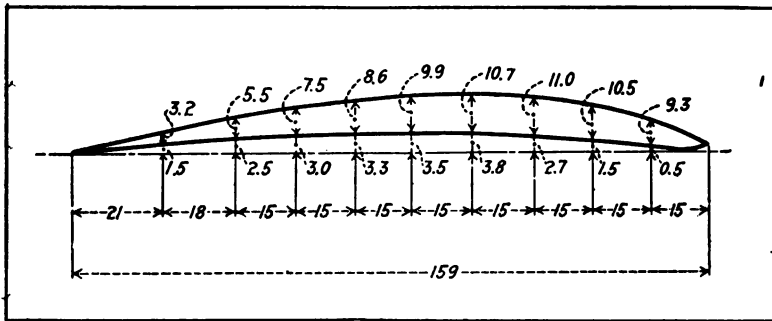


Fig. 27. Aerofoil Section of Modern Airplane Suitable for Heavy Loading.

the present construction of a tilted aerofoil of fixed cross-section is by no means the best, if one looks at it from a theoretical point of view, though it is a compromise that gives adequate results in practice. To secure the best results from an aerofoil as regards lift, drift or resistance and center of pressure position, the section of the aerofoil should be changed with every alteration of flying speed. This is a theoretical consideration that is difficult to meet in practice, owing to structural difficulties. Inasmuch as a practical variable camber wing has not yet been designed, the fixed aerofoil section to be selected depends upon the type of plane and the work it is expected to do.

**Wing Sections Vary in Design.**—Various wing sections intended for widely differing types of machines are shown at

Fig. 28. That at *A* is intended for a fast scout plane and while the section is a good streamline form, the lift is so small at moderate speeds that it can be used only on very fast flying planes. The same applies to the aerofoil shown at *B*, which has a reverse curvature at the trailing edge. This wing has good aerodynamical properties because the center of pressure travel is small, but as its lifting power is low compared to the

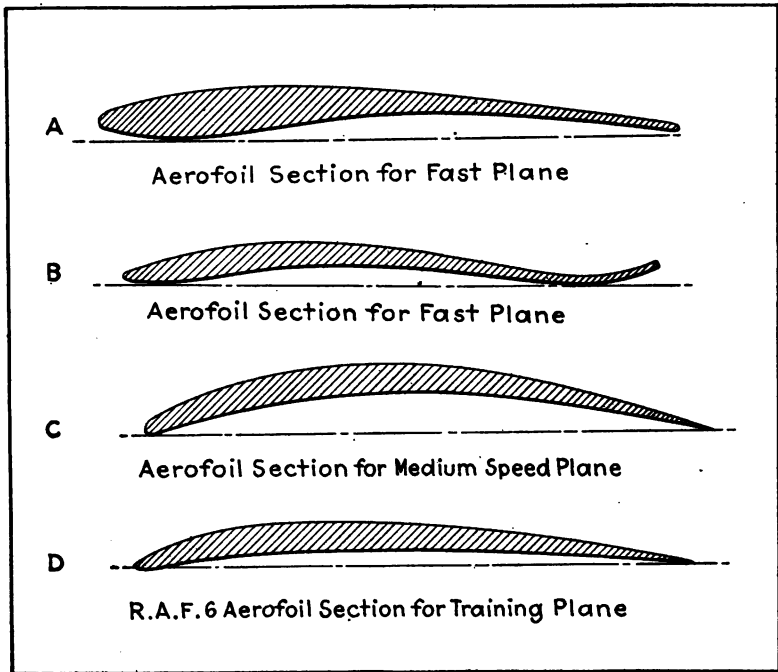
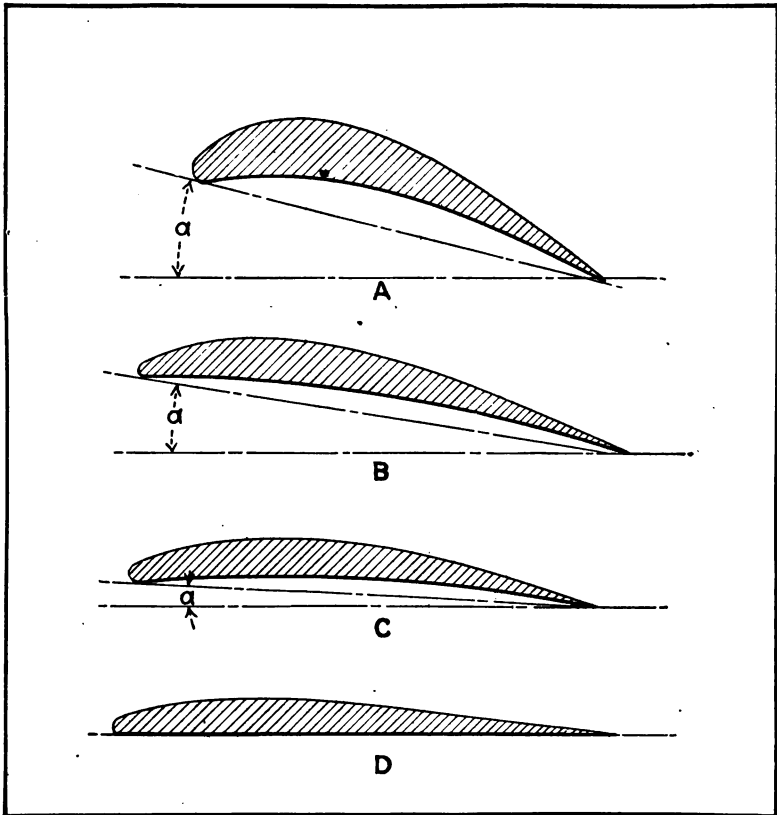


Fig. 28. A and B, Aerofoil Sections for Fast Planes. C, Aerofoil Section for Medium Speed Plane. D, R. A. F. 6 Aerofoil Section for Training Plane.

sections shown at *C* and *D*, can be used to advantage only on speedy machines. Wings of the forms shown at *C* and *D* are used on medium speed biplanes. The landing speed of a small plane having wings of the section shown at *A* and *B* would be about 50 miles per hour, and would call for very skilful piloting. The other wing section at *C* and *D* are suited for medium speed biplanes, as they would permit a landing speed of about 30 miles per hour. The maximum

speed of a properly powered plane using wing sections *A* or *B* may attain values of over 100 miles per hour, that of sections *C* and *D* would not be much more than 65 or 75 miles per hour.

In order to illustrate how widely the requirements differ and the types of aerofoils best adapted for use under different conditions of airplane operation, the sections at Fig. 29 are



**Fig. 29. Aerofoil Sections Designed for Special Work, Showing How Widely They Differ.**

given. These are reproduced from A. W. Judge's treatise, "The Properties of Aerofoils and Aerodynamic Bodies," and show ideal wing sections.

The wing form required to secure the highest lift with the most efficiency is shown at *A*. Such an aerofoil would be

suitable only for a low-speed machine, as it would offer a high head resistance even at small angles of incidence. It would be a good form for slow flying machines but very inefficient for high-speed types. The section at *B* is typical of aerofoils intended for medium flying speeds and at the same time secure a fairly low landing speed. An aerofoil of this type could be utilized for a machine having a flying range between 35 and 65 miles per hour. The wing at *C* shows a section developed to obtain a high lift-drift ratio at small angles of incidence, and while a machine equipped with aerofoils of this section would not have a very low alighting speed, it could attain fairly high flying speeds as the range would be from 55 to 100 miles per hour. The wing section at *D* is a peculiar aerofoil designed for very high speeds. It would be entirely unsuited for low-speed work and is to be used only on machines of very high power. The landing speed would be very high as the angle of incidence is negligible in normal flight.

## EFFECT OF AEROFOIL CAMBER

Both upper and lower cambers of an aerofoil have material influence on the aerodynamical properties. Very complete experiments have been made to determine both the upper and

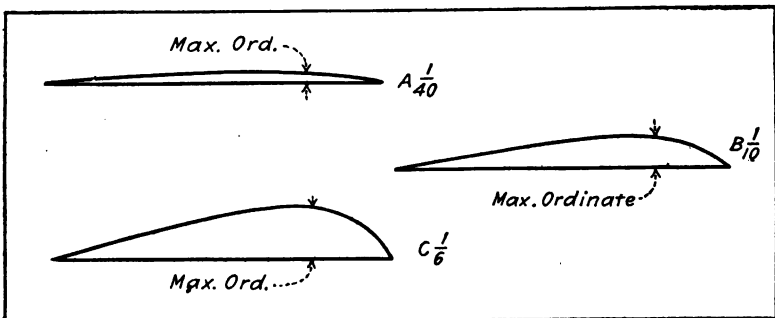


Fig. 30. Wing Sections Experimented with to Determine Value of Top Camber

lower cambers, and considerable data is available for the student. It is not within the province of a discussion of this character to go deeply into the theory of form and proportions, but it may interest the reader to consider typical designs in

both cases and study the values determined for each form. For example, a range of sizes of which the forms shown at Fig. 30 are examples were tested, all having a flat lower surface but with upper surfaces of varying convexity and depth of section. The figures in the illustration show the proportions the maximum ordinate bears to the chord. The position of the maximum ordinate was the same in each case, or about 0.292 of the chord from the leading edge. It is found that the thicker the aerofoil the greater the lift coefficient at small angles of incidence. This is undoubtedly due to a greater total deflection of the air. The thin aerofoil at *A* starts to lift at minus or 1 degree of incidence, but the thick section at *C* starts to lift at minus 7 degrees angle. At 0 degrees angle of incidence the values of the lift coefficient are proportional to the depth of sections. The section best adapted for a wing is one that has a top camber that is an average between the form shown at *A* and *B*, the depth of the camber being about  $\frac{1}{20}$  the chord length. The camber shown at *C* is used only in propellers, and then only where strength is desired, as near the hub. It would have too much resistance to be used for a wing section.

#### EFFECT OF VARYING LOWER CAMBER

In order to determine the influence of various lower cambers, a series of aerofoils were made with various degrees of concavity. A series of tests were made with four aerofoils having sections as outlined at Fig. 31. The deduction that can be made from the data shows that the under-camber influence is to increase the lift at all angles and even at small angles the percentage increase is considerable. The form at *D* has the greatest lift coefficient value. At zero angle of incidence the form at *B* has 13.9 per cent. increase over *A*; *C* has 24.2 per cent., and *D* has 33.3 per cent. increase over the form with the flat under-surface. The upper camber was the same in all cases. At 6 degrees angle of incidence the percentage increase varies as follows: *B*, 4.9 per cent.; *C*, 8.2 per cent.; *D*, 12.9 per cent. At 10 degrees angle of incidence the form at *B*

has 2.8 per cent. increase; *C*, 7.3 per cent. increase, and *D*, 11.2 per cent. increase.

It is therefore evident that the best form for securing maximum lift at low speed will have both upper and lower surface cambers pronounced. A sharp leading edge is not as good as a slightly rounding one. The wing sections of birds show a fine tail angle and have considerable under camber as

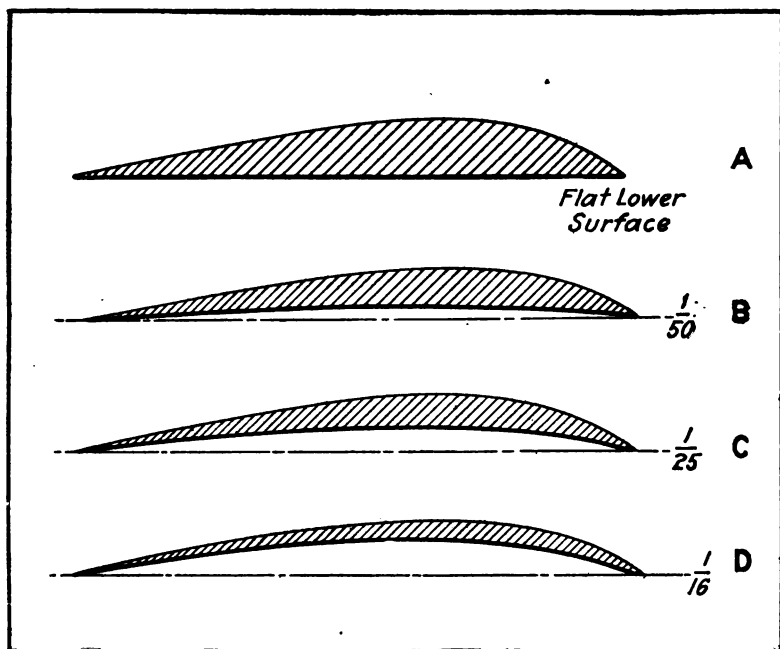


Fig. 31. Wing Sections Experimented with to Determine Value of Various Bottom Cambers.

well as a pronounced upper camber and a rounded entering edge. It is possible to obtain 10 to 15 per cent. more lift at high angles of incidence by using a fine tail angle and a good under camber. For high-speed work it is evident that aerofoils having a good upper camber but a nearly flat lower camber or forms having two convex surfaces as shown at Fig. 29, *C* and *D* will be most suitable.

**Pressure Distribution on Aerofoils.**—Consideration has previously been given to the various aerofoil sections and



diagrams have been presented showing the supposed air flow about the cambered sections so that a definite lift could be obtained both from the positive pressure existing below the plane and the negative pressure existing above it. It is ap-

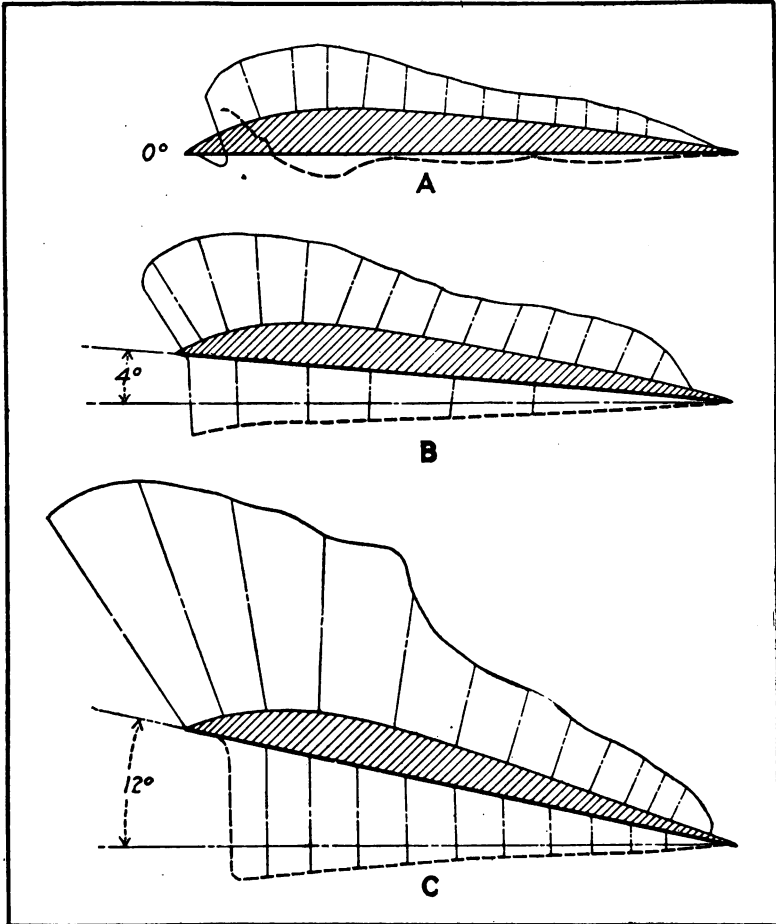


Fig. 32. Graphic Diagrams Showing Pressure Distribution on Top and Lower Surfaces of a Cambered Aerofoil at Varying Degrees of Inclination.

parent that the greater part of the lift at normal angles of incidence is secured by the negative pressure and that this is always greater than the positive pressure below the plane regardless of angle of incidence. Pressure observations have

been made by Eiffel and others with aerofoils of varying cross-sections and while numerous interesting deductions could be made by studying the entire series of tests, in a discussion of this character it is only necessary to study typical diagrams which show graphically the pressure distribution.

Referring to Fig. 32 a deep cambered wing section is shown at *A* that has no perceptible angle of incidence. The pressure distribution is represented graphically by normals drawn from both upper and lower surfaces of the aerofoil and having the degree of pressure existing indicated by making the length of the lines proportional to the existing pressure. The positive lift is denoted by normals drawn from the lower surface down, while the negative pressure or suction lift is indicated by lines drawn normal to the upper cambered surface. It will be evident that at zero angle of incidence all of the lifting force present on the wing is produced by the negative pressure or suction lift above the cambered surface. There is a certain amount of negative pressure on the underside of the aerofoil at the entering edge which actually detracts from the efficiency by reducing the lift. It will be apparent that in the wing of a fast airplane, the top surface should be so designed as to carry practically all of the load. The aerofoil tested had an aspect ratio of six and the tests were made at a wind speed of a mile per minute, or 60 miles per hour, which would correspond to a normal flying speed for an aeroplane having deeply cambered wing section and only moderate power.

#### POSITION OF MAXIMUM EFFICIENCY

The maximum efficiency of the aerofoil was obtained with the wing at the position shown at Fig. 32 *B* in which the angle of incidence is 4 degrees as, while the lift is not as great as it is at a higher angle of incidence, it is at this position that the greatest lift is obtained with the least resistance. It will be observed that there is more uniform distribution of pressure upon both upper and lower surfaces, and while the value of the negative pressure is of considerably greater amount than that of the positive lift, both of these attain their greatest value but a short distance from the leading edge. At 12 degrees inclina-

tion, which can be considered the position of maximum lift, the great increase in the negative pressure effect near the leading edge at this angle of incidence is easily noticed; also the progressive falling off toward the trailing edge.

#### POSITION OF CENTER OF PRESSURE

From these graphic diagrams it will be evident that it is because of the greater magnitude of both positive and negative pressure effects near the leading edge that the center of pressure is nearer to the leading edge than to the center of the aerofoil section at ordinary angles of flight. While the position of the center of pressure varies, it may be stated to average about one-third of the length of the cord from the leading edge. With a certain aerofoil section the pressure upon the upper surface near the leading edge at an angle of inclination of 10 degrees and with a wind speed of a mile per minute is about 40 pounds per sq. ft., while near the trailing edge it is about 3 pounds per sq. ft. only, which makes the average lifting force for the whole surface about 10 pounds per sq. ft.

#### WHAT IS MEANT BY CRITICAL ANGLE OR BURBLE POINT

If an aerofoil is tilted from 0 incidence, the values of the suction lift or negative pressure on the top camber continually increase until a certain angle is reached which invariably lies between 14 degrees and 20 degrees, where a pronounced change in the values of the pressures occurs and where a further increase results in a practically uniform and reduced lift. This is called "the critical angle" because, as has been previously shown, the value of the lift coefficient becomes suddenly reduced, while the drift coefficient, which is a measure of resistance, increases greatly. The sudden change in the pressure distribution is sometimes called "the burble point" and is evidently due to a sudden alteration of the air flow over the camber of the top surface of the aerofoil, and air flow in which there are so many eddy currents that there is a dead air region which offers resistance without producing any useful lifting effort.

**Greatest Lift Produced by Upper Surface.**—It will require but brief study of the graphic pressure diagram given at Fig. 32 to ascertain that of the total lifting force on a cambered surface aerofoil that the greatest lifting effect is due to the negative pressure or suction lift on the upper surface. The amount of this lift will vary with the section of the aerofoil, and it may be stated to range from 75 per cent. in the case of a flat plane to as high as 92 per cent. in the case of a cambered plane at zero angle of incidence. In the case of aerofoils having a fairly flat lower surface, the upper surface at 0 degrees incidence practically supports the load. At 4 degrees the lower surface contributes but 18 per cent. of the lifting effect. Aerofoils designed for fast flying are of such form that the upper surface contributes from 95 to 100 per cent. of the total lift while in cambered sections designed for slower-speed machines the upper surface is responsible for from 65 to 85 per cent. of the lifting influence. The following table shows the percentage of the total load carried by both surfaces in an aerofoil having a fairly high total lift.

TABLE VI  
PERCENTAGE OF TOTAL LOAD CARRIED

Angle of Incidence.	Lower Surface.	Upper Surface.
0 degrees	8	92
4	18	82
6	26	74
8	28	72
10	31	69

## CHAPTER V

### ARRANGEMENT, CONSTRUCTION AND BRACING OF AIRPLANE WINGS

Monoplane or Biplane—Effect of Gap—Table 7—Effect of Stagger—Plane Forms—Securing Uniform Pressure Distribution—Airplane Wing Construction—Wing Covering Fabric—Why “Dope” is Used for Wings—How Fabric is Fastened—Airplane Wing Bracing—Loads on Airplane Wing Wires—Airplane Wing Form—Planes with Longitudinal Dihedral—Influence of Lateral Dihedral—Airplane Wing Bracing—Side Bracing of Airplane Wings—Airplane Bracing Wires—Typical Wire Bracing Arrangements

#### MONOPLANE OR BIPLANE

THE latest developments in airplane construction have resulted in such a great increase of efficiency for the biplane type that it is now practically universally used. In the early days the monoplane was the type used for carrying light loads at high speeds while the biplane was the form favored for carrying heavy loads at relatively slower speed. The biplane is undoubtedly the form having the greatest structural strength as well as permitting one to obtain the greatest amount of carrying surface in the most compact form. For example, if we consider a biplane having 40 ft. spread with a 6 ft. chord we have planes having a surface of 240 sq. ft. each or a total of 480 sq. ft. for the two planes. If one desired to obtain this same area in a monoplane and did not wish to depart from an efficient aspect ratio it would be necessary to use a single plane having a 60 ft. spread and an 8 ft. chord. It will be apparent that the design of a wing structure of these dimensions would be somewhat of a problem and it would require a high grade of engineering to have a strong wing skeleton which would be properly braced without making the framework too heavy.

As the weight that can be sustained with a given amount of power depends largely upon the area of the useful supporting

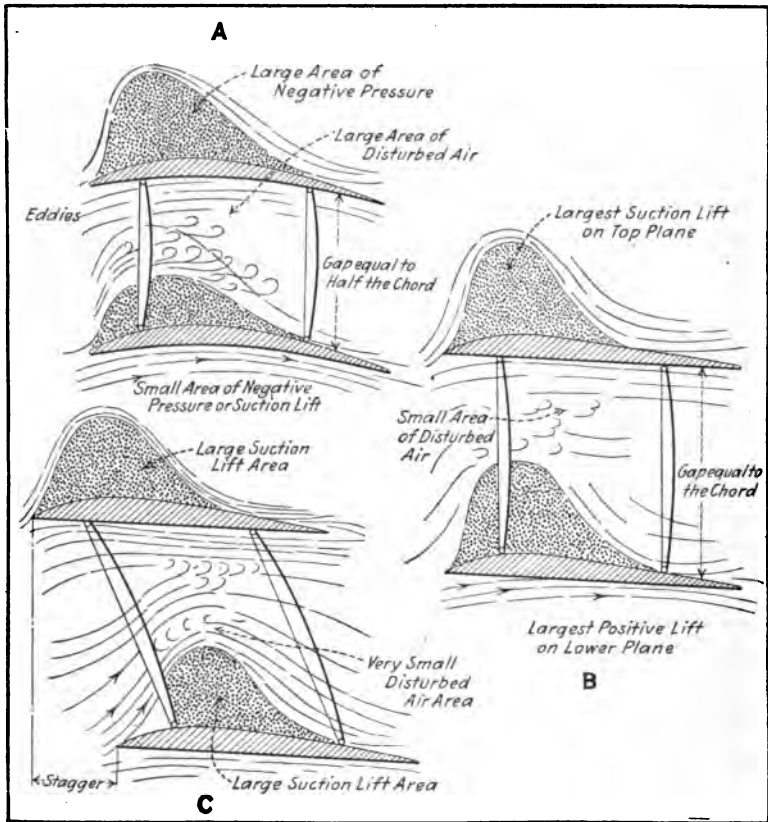
surface and the velocity of the plane through the air, it is evident that if one decreases the supporting surface that one lessens the carrying ability. Of course, if more power is provided and higher speeds obtained the wing loadings can be increased from the average value of 3 or 4 pounds per sq. ft. to twice that amount, but this can be secured only by the sacrifice in low landing speed. The real reason why the monoplane was favored in the early days was because plane forms and their proper relation had not been as carefully studied as they have been in recent years. It was found that the efficiency of a surface was reduced if other planes were carried near it. It was therefore necessary to correct monoplane values to allow for the biplane arrangement.

#### EFFECT OF GAP

The results of wind tunnel tests upon exactly similar aerofoils arranged one above the other shows that there is a disadvantageous interference due to conflicting air currents between the two planes unless there is a gap between the planes of at least twice the chord. If the gap between the planes is less than this figure there is a reduction in the lift effect of the two planes. The condition can be easily understood if one refers to the diagram at Fig. 33 *A*, which shows two planes separated by a distance equal to only half of the chord. It will be evident that there is a large area of disturbed air between the two planes. This results in a reduction of the positive lift on the upper plane and of the negative lift on the lower one. We then have two surfaces working at greatly reduced efficiency and we are depending upon the efficient upper surface of the top aerofoil and the efficient lower surface of the lower aerofoil.

The diagram at Fig. 33 *B* shows the planes separated by a distance equal to the length of the chord. This is the usual spacing and while it is not the most efficient one it is the distance commonly used on account of structural reasons. There is still an opportunity for a conflict of the air currents between the surfaces but the area of disturbed air is considerably less than in the case where the gap was equal to but half the chord. When the gap between the planes is equal to the chord a bi-

plane has an efficiency of but 80 per cent. of a monoplane of the same wing area and aerofoil section.



**Fig. 33.** Diagrams Showing Effect of Biplane Spacing. A. With gap equal to half the chord, note interference and eddies. B. With gap equal to chord. C. Effect of staggering aerofoils.

It will be seen from the following table that the gaps tried varied progressively from 0.4 to 1.6 of the chord. The coefficients given are values by which the monoplane lift coefficients have to be multiplied in order to secure the biplane spacing values for the gaps given. The wing tested was the form used on the Bleriot-XI, of a plan form that had a rounding wing tip and a shorter trailing edge than entering edge. The spread was about five times the chord. From the table it will be evident that the best arrangement or spacing of the biplane

wings is determined by practical considerations. While there is an increase in efficiency as the gap increases there is a corresponding increase in the length and consequently the resistance of the plane spacing struts, the lifting and landing bracing wires and also the incidence wires. Practical considerations generally limit the gap or spacing so that it seldom exceeds the chord.

TABLE VII  
CORRECTIONS FOR BIPLANE SPACING

RATIO GAP	LIFT COEFFICIENT		
	Chord	6 Degrees	8 Degrees
0.4	0.61	0.62	0.63
0.8	0.76	0.77	0.78
1.0	0.81	0.82	0.82
1.2	0.86	0.86	0.87
1.6	0.89	0.89	0.90

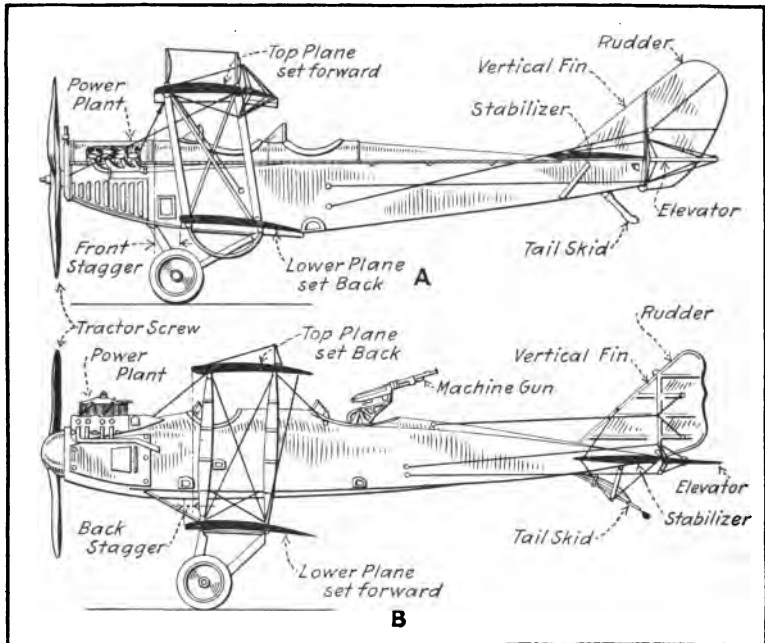
#### EFFECT OF STAGGER

The efficiency of the biplane arrangement can be increased by staggering the planes, *i.e.*, setting the entering edge of one plane some distance ahead of the entering edge of the other. A somewhat exaggerated stagger is shown at Fig. 33 C. The effect of moving the top plane forward is to increase the lift coefficient as well as obtaining a higher value of the lift-drift ratio. When the top plane is moved forward a distance equal to about two-fifths of the chord an increase in both lift and lift-drift coefficient of about 5 per cent. is secured. This is equivalent to increasing the gap from 1.0 to 1.25 of the chord. Staggering the planes improves the efficiency of the upper plane because it reduces greatly the disturbed area between the planes. The planes are not always staggered forward; sometimes the lower plane may be set ahead of the upper one. The best effect is obtained by using the positive stagger rather than the negative as the range of vision of the occupants of the airplane is much better when the top plane is staggered forward and a more decided gain in efficiency is obtained. The views at Fig. 34 show two types of tractor biplanes. That at A shows a standard training machine which has a positive



or front stagger, in this the upper plane is set forward of the lower plane. The design shown at *B* has a slight negative stagger as the lower plane is set somewhat ahead of the upper one.

**Plane Forms.**—It is not the purpose of a popular discussion of this character to consider the technical aspects of pressure



**Fig. 34. Typical Tractor Biplanes of Modern Design Showing Positive or Forward Stagger at A and Negative or Back Stagger at B.**

distribution over the entire surface of the wings, but enough has been presented in a preceding consideration of this subject to show that the pressure is not uniform at all points on the wing. While considerable useful information may be secured if careful thought is given to the variations in pressure along the leading edge of the wing and at some distance back of this line on both upper and lower surfaces, experiments have shown that the values of the positive and suction lift over the central portion of the aerofoil or those parts near the fuselage were greater than at other portions of the wing and that the values of the positive and negative pressure became less near the wing tips.

The reason for this is that the air that is under pressure at that part of the wing near the tips has nothing to restrain its flowing out sideways and inasmuch as this escape of air over the edges produces eddy currents, the value of the suction lift at the top will be likewise reduced. The reason that wings of reasonably high aspect ratio are more efficient than those forms of low aspect ratio is that the relative magnitude of the loss in lift due to the escape of air will be less in proportion to

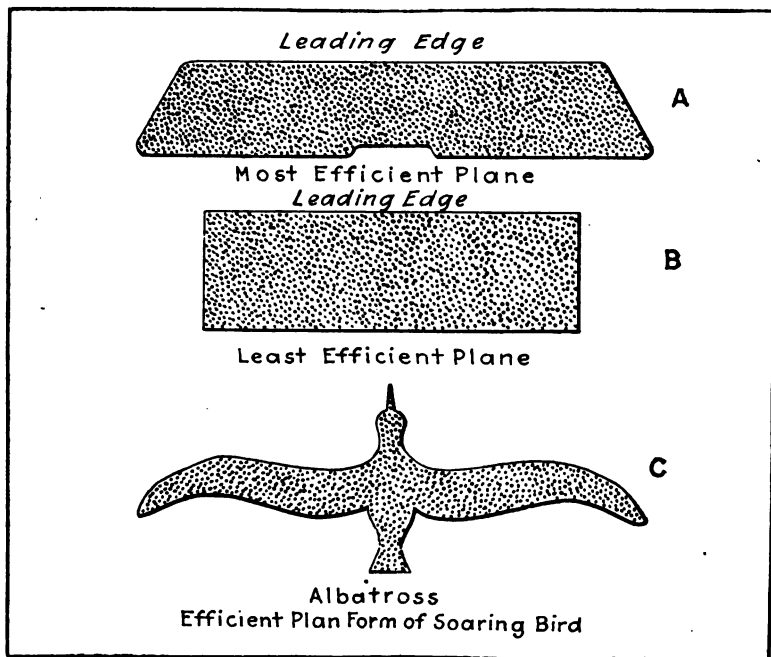


Fig 35. Diagram Showing Efficient Wing Plan and How It Approximates Bird Wing Plan Form to Some Extent.

the total surface on a wing of large span and small chord than it will be on an aerofoil of short span and long chord having the same area. This means that there is a gradual movement of the center of pressure from the leading to the trailing edge of the wing, the center of pressure being nearer the leading edge at the central point of the wing and nearer the trailing edge at the wing tips.

The early forms of planes were built of a rectangular plan

form as shown at Fig. 35 B. This was done because the influence of plan form on efficiency was not clearly defined and because it was a very easy form of wing to build, calling for a very simple framework, and, in fact, the single surface aerofoils of early days were not adapted to use the wing frame skeletons that are now available since the double surface aerofoils became universally used. The rectangular plan form is less efficient aerodynamically than the later forms even on those wings having a high aspect ratio. The form of wing shown at Fig. 35 A is more efficient than the simpler rectangular form shown below it, as this gives an increase in total effective lift with a marked reduction in resistance or drift and

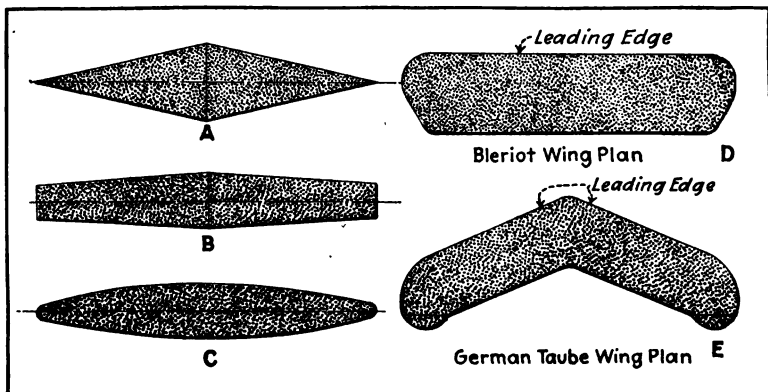


Fig. 36. Theoretical Plane Forms to Secure Uniform Pressure Distribution at A, B, and C. Actual Plane Forms at D and E.

at the same time there is no sacrifice of any of the constructional features making for strength stability or ease of building.

**Securing Uniform Pressure Distribution.**—In order to secure a reasonably uniform pressure distribution it has been stated that an ideal plan form would be one consisting of two triangles having their bases joined at the central section, the apex of each triangle representing a wing tip. This form of wing, which is shown at Fig. 36 A, would offer certain structural disadvantages, but even with the forms of wings generally used to-day there would be a marked improvement in efficiency if a form such as shown at Fig. 36 B were used in which the

wings are widest or have the greatest chord at the center and gradually tapering away to small chord dimensions at the tips. The disadvantage in wing form of either of the types *A* or *B*, Fig. 36, is that there would necessarily be a grading down of the total depth or camber of the section to correspond to the lessened chord. Lanchester, in experimenting with wing plan forms, suggested the parabolic plan forms shown at Fig. 36 *C* and experiments have demonstrated that this would yield very good results that would be more satisfactory than those obtained with the rectangular shape first used.

The plan form and sections of the wings of birds have been previously considered, but it is not always possible to select the best type of aerofoil by their wing section, neither is it possible or desirable to approximate their wing plan in making airplanes. The plan view given of a soaring bird, the albatross which has a wing spread of high aspect ratio, would be difficult to duplicate in an airplane wing on account of structural considerations. Two forms of wings that have been patterned with the object of securing greater efficiency than with the regular rectangular form are shown at Fig. 36. That sketched at *D* is the wing plan of the Bleriot monoplane, while that at *E* is the German Taube wing. Some similarity between this wing plan and that of the bird is evident, as a portion of the wings of the albatross near the tips has a decided "sweep back," or retreat, which is also seen in the Taube wing plan.

The aspect ratio of the wings of the albatross is about 14, meaning that the wing span is approximately 14 times the chord. The average airplane will have an aspect ratio ranging from six to eight. The shapes of birds' wings, both as relates to the section and the plan view, are undoubtedly determined by other considerations besides those of aerodynamical efficiency. It is evident that the habits and mode of flying of the bird have a material bearing on the wing plan. It may be said, however, that birds which in their flying more nearly approximate the airplane have wing plans that would no doubt be satisfactory on the soaring machine if constructional difficulties did not intervene to make their practical application of somewhat dubious value.

**Airplane Wing Construction.**—Having considered at some length the aerodynamical properties of airplane wings and aerofoil sections, we will now proceed to discuss the wing structure from the practical viewpoint of the airplane constructor rather than that of the designer. As will be evident from the illustrations at Fig. 37, the wing skeleton before covering is a framework consisting of two longitudinal spars which are joined together by equally spaced ribs running from the leading edge to the trailing edge of the wing. The section of the aerofoil is always greatest at the front spar because most of the lift occurs near the leading edge. By employing spacing strips of the proper curvature it is, of course, possible to obtain ribs of any section, and it is the degree of camber given the ribs that determines the lifting properties of the wings when the framework has been covered.

The ribs are built up of narrow strips of wood about an inch wide and a quarter inch thick, which are placed at the top and bottom of the curved central rib member that determines the camber of the aerofoil. The front ends of these strips are connected to a small moulding or leading edge spar that is termed the "nose" of the wing. The various ribs are tied together by light round wooden rods that extend from one end of the wing to the other. All portions of the wing structure are glued and screwed together, so that while a large number of individual pieces are employed in the wing frame the methods of joining them together are so secure that the completed structure has surprising strength for its weight. A fabric is stretched tightly over the wing frame and is fastened to both upper and lower surfaces of the ribs and spars.

The leading edge is sometimes given a positive curvature by using a thin veneer of wood so as to give the cloth a definite form at the entering edge of the wing. Wire bracing is extensively used inside of the wing to stiffen it. The tie wires join the front and rear spars and are of great value in stiffening the wing structure. The rear spar carries only a relatively small percentage of the total load of the wing, and for that reason is usually considerably smaller in section than the front spar. Wing spars may be made of either ash or spruce,

and experiments that are being made may demonstrate that metals such as aluminum may be used advantageously for this purpose. The ribs are usually made of poplar or spruce, though in some cases mahogany has been employed.

WING COVERING FABRIC

The wing covering is a fine, closely woven linen and especial care is taken to secure both strength and lightness. The

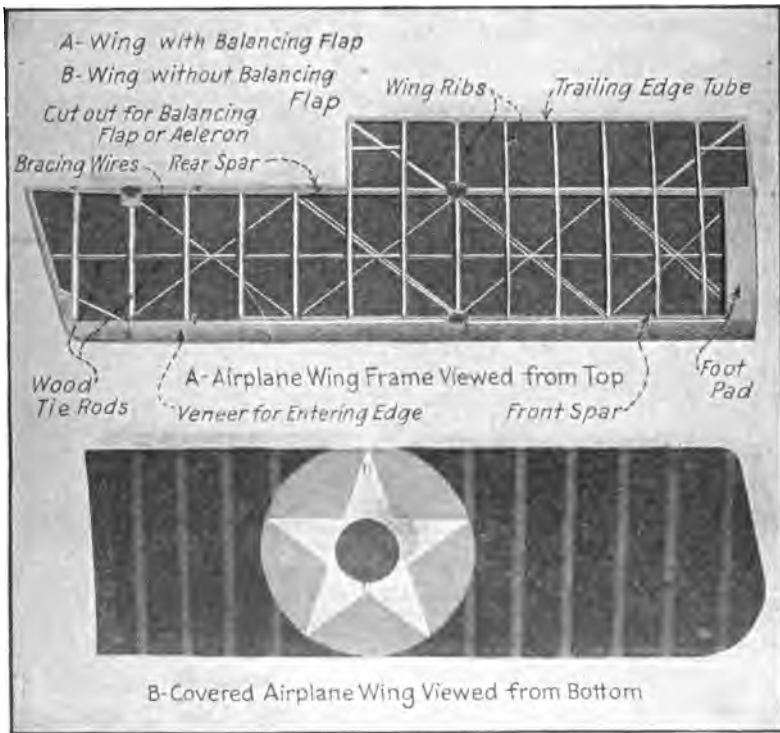
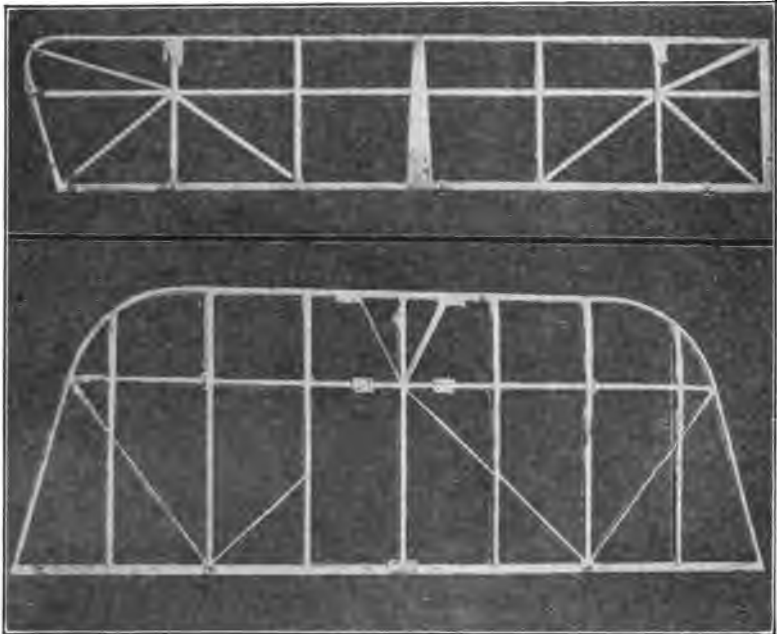


Fig. 37. Typical Airplane Wing Skeleton and Appearance after It is Covered with Fabric.

weight of airplane wing fabric generally used will vary from four to five ounces per square yard. Its tensile strength varies from about 75 pounds per inch width in the warp direction (*i.e.*, those threads of a fabric that are stretched lengthwise in the loom when the material is woven) and of about 100

pounds per inch in the weft direction. The weft threads are shorter than the warp threads, as they are those that are carried back and forth by the shuttle in weaving. Owing to the greater strength of the fabric along the weft threads it is usually attached to the wing skeleton so that the warp threads



**Fig. 38. Skeleton Structure of Aileron or Balancing Flap at A (Above) and of Stabilizer at B (Below).**

run in the same direction as the ribs. No matter how finely woven the linen is, it is apparent that it cannot be made either air-tight or water-tight. It is also evident that it would be difficult to stretch the linen covering so it would be uniformly tight in all directions.

#### WHY "DOPE" IS USED FOR WINGS

The fabric is made air-tight and water-proof and is also stretched to a taut surface like a drum head by the use of chemical preparations called "dope" in the trade. Practically all of these are cellulose acetate dissolved in some

solvent such as ether, alcohol or acetone. A number of coats of this "dope" are given the wings and each is allowed to dry thoroughly before the next coating is applied. Owing to the highly volatile nature of the solvents used, this drying is fairly rapid. The first coat penetrates all the spaces between the threads and also penetrates the fibers of the threads themselves. As the drying proceeds the substance contracts and brings the threads more closely together. From four to five coats of "dope" are applied to the surface of the linen, the increase in weight due to the use of the "dope" being about one and one-half ounces per square yard. The "doping" is said to increase the strength of the fabric by about 20 per cent.

#### HOW FABRIC IS FASTENED

The fabric is called upon to sustain a load of about 20 pounds per sq. ft. at a flying speed of 70 miles per hour, so it is securely attached to the ribs. The method generally used is to tack through light strips of cane or wood which acts as a spacing member to prevent the tack heads from breaking the linen. A certain amount of the "dope" penetrating the linen will stick it to the ribs and in some cases a stitching of flax cord is used to tie the fabric firmly to each wing rib at both upper and lower surfaces. Wings that have been tested to destruction demonstrate that this method of fastening is extremely strong, and the writer has seen wings that have been damaged in wrecks in which the main spar has fractured and yet the fabric will be held securely to the ribs. When the stitching is employed, the cord and knots on top and bottom of ribs are covered with narrow strips of fabric about two inches wide which is securely "doped" into place in order to provide a smooth covering and to lessen the skin friction. In order to give a smooth finish to the wing after doping it is sometimes smoothed down with sandpaper and a coat of spar varnish applied.

**Airplane Wing Bracing.**—Mention has been made previously of the strength obtained by the biplane arrangement of wings because a set of fitting surfaces are held together by tension wires passing in three dimensions, forming the assembly



into a very light box girder. Referring to Fig. 39 it will be seen that wires are placed between each pair of struts or compression members and that these are tension members which tend to bring the wing spars tightly against the struts of spacing members. One wire extends from the top rear spar to the bottom front spar. The other from the top front spar

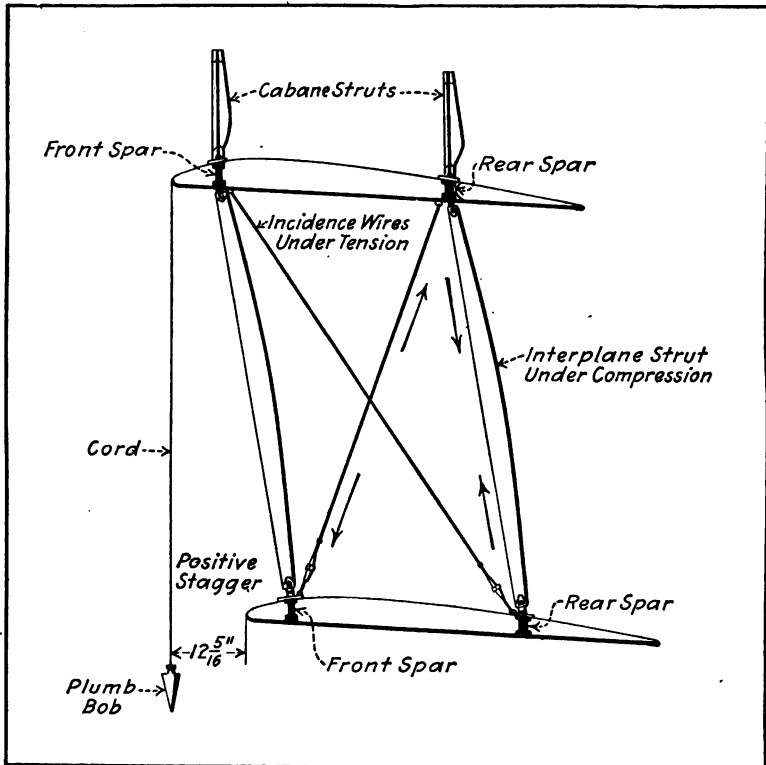


Fig. 39. Diagram Showing the Use of Incidence Wires between Planes Mounted in Staggered Relation.

to the bottom rear spar. These wires are called "incidence" wires, as they keep the planes in the proper angular relation to each other.

One advantage of a biplane is that the wings can be completely assembled and braced up independently of the fuselage. This means that they can be handled as a unit and readily

installed. A typical wing section assembled on one side of the biplane fuselage is shown at Fig. 40. When the airplane is in flight the lift exerted on the wings will, of course, tend to force them up while the weight of the fuselage tends to force them down at the center. The result of this combined force is that the wings tend to fold up from the tips inward towards the fuselage. It will be evident that bracing wires are necessary to prevent this. The upward pull of the upper parts exerts a lift and puts some of the diagonal wires under a tension loading. The lift on the lower spars imposes a com-

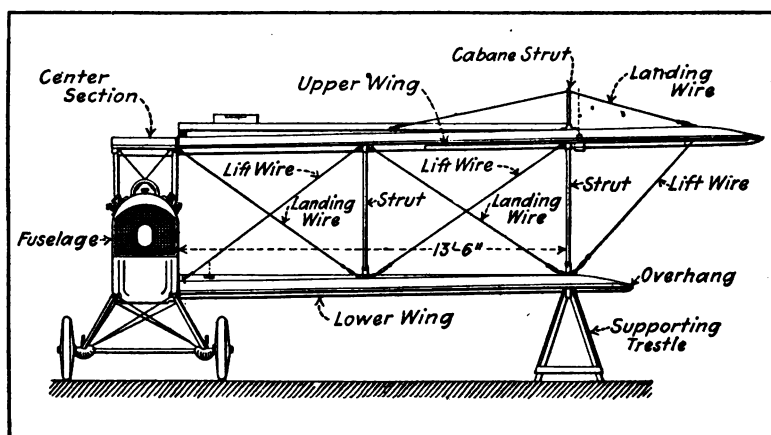


Fig. 40. Diagram Showing How Braced Biplane Wing Assembly Forms a Complete Structure That May Be Easily Assembled as a Unit to Biplane Fuselage.

pression strain in the spacing struts between the planes. Under this condition the top spars are in compression and the lower ones under tension. When the machine is in flight the load is carried by only one set of wires which are, therefore, known as lifting wires. The opposing diagonal wires do not carry any load when the machine is in the air, but, however, when the machine alights and the wings lose their lifting effect the other set of wires is brought into play, and for this reason they are called landing wires. When the machine is in the air the flying wires are in tension or stretched while the landing wires are slack. When the machine is resting on the ground on its landing gear the conditions are reversed and the

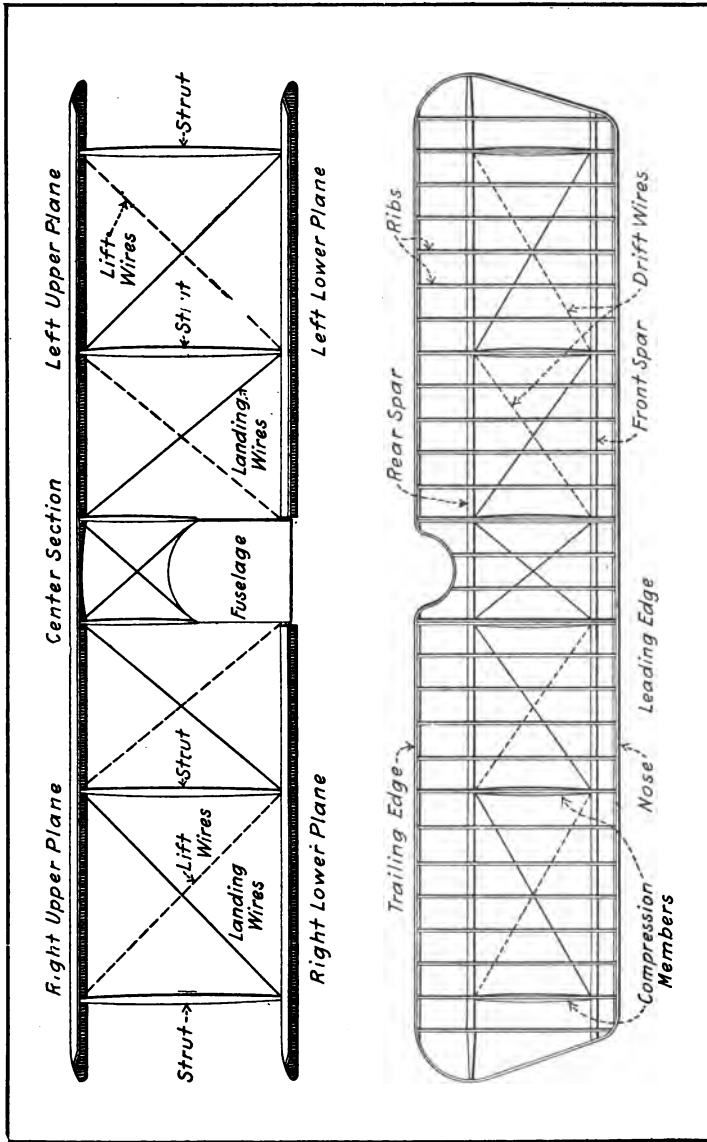


Fig. 41. Diagrams Indicating the Arrangement of Lift and Landing Wires and Relation to Interplane Bracing Struts and also the Drift Wires and Compression Members in the Airplane Wing Structure.

flying wires do not carry any load while the landing wires are in tension. When the machine is resting on the ground the top wing spars are in tension and the bottom wing spars are under compression. Obviously the spacing struts between the wings remain under compression all of the time.

#### LOADS ON AIRPLANE WING WIRES

An airplane wing is not only subject to a lift reaction, but also a drift reaction. As the machine flies through the air the pressure of the air against the wings exerts a horizontal loading that tends to fold the wings backward at the same time that the lift reaction tends to fold them upward. Horizontal bracing wires are provided in the wings to prevent the rear spar from bending backward and are known as drift wires, while compression struts are placed between the front and rear spars to hold the front spar at the correct distance. In some airplanes special wires extend from the front end of the fuselage to both front and rear spars of the wings to take the drift reaction. These wires are clearly indicated in Fig. 42.

The bracing wires are called upon not only to resist the elementary forces considered, but while performing evolutions in the air they may be subjected to combination strains resulting from loads coming in different directions that cannot be computed accurately. It is therefore important that the bracing wires have a wide margin of safety over the actual requirements. It is also evident that one of the important items in connection with airplane maintenance is to make sure that the bracing wires are always at the correct tension and that they are securely fastened and not frayed or weakened in any way. In order to prevent the bracing wires from rusting, those that are inside of the wing structure are painted or enameled, while the bracing wires that hold the planes together and which can be easily inspected are kept covered with a coating of graphite grease. In tightening bracing wires it is important that only the proper amount of tension be given, as, if the turnbuckles are tightened too much the interplane struts are apt to be bowed and their strength greatly reduced.

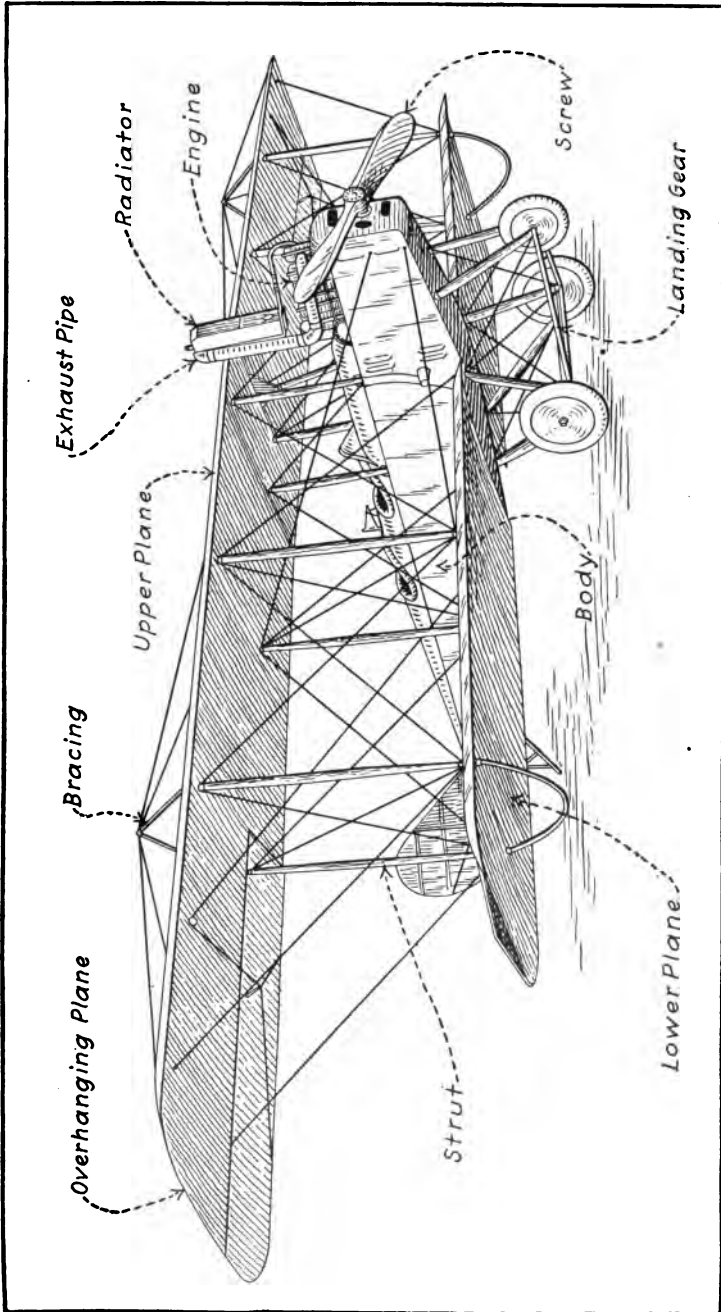


Fig. 42. Three-quarter Front View of Typical Biplane Showing Relation of Interplane Struts and Functions of Bracing Wires.

**Airplane Wing Form.**—Mention has been made previously of the influence of varying wing forms if considered from their plan view and a number of simple diagrams have been pre-

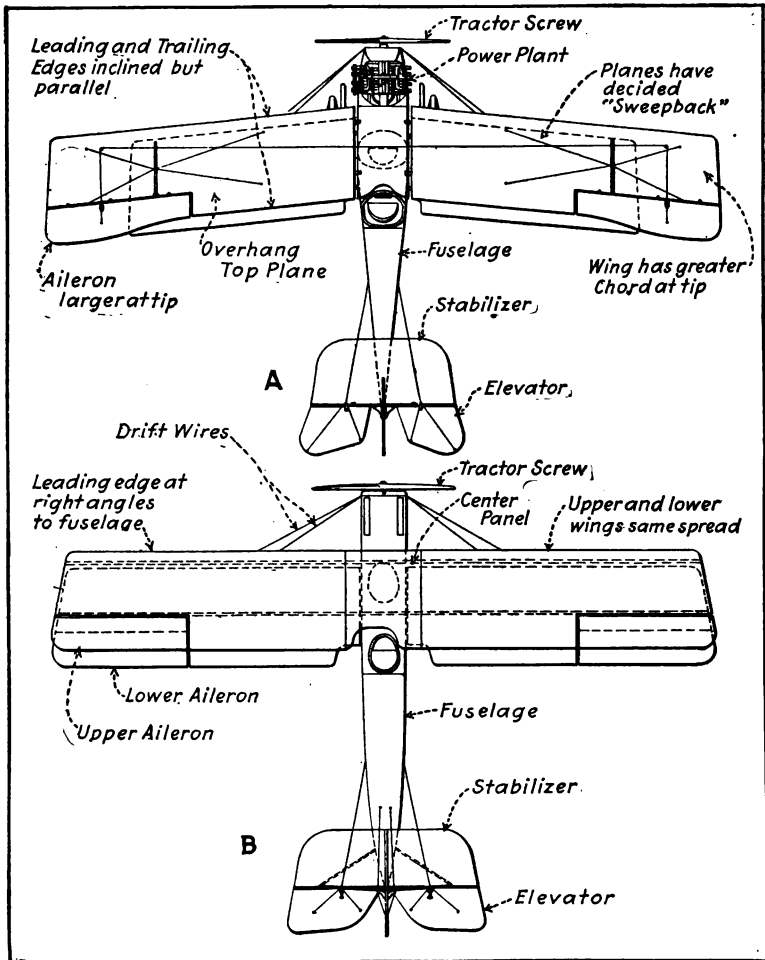


Fig. 43. A Comparison between Two Accepted Types Showing How the Ideas of Designers Differ. Note That the Plane Shown at A Has Upper Wings of Greater Spread Than the Lower, While the Plane Shown at B Has Wings of the Same Spread.

sented showing typical wing plans. The arrangement of the airplane supporting surfaces in relation to the rest of the airplane structure and the manner in which theoretical forms

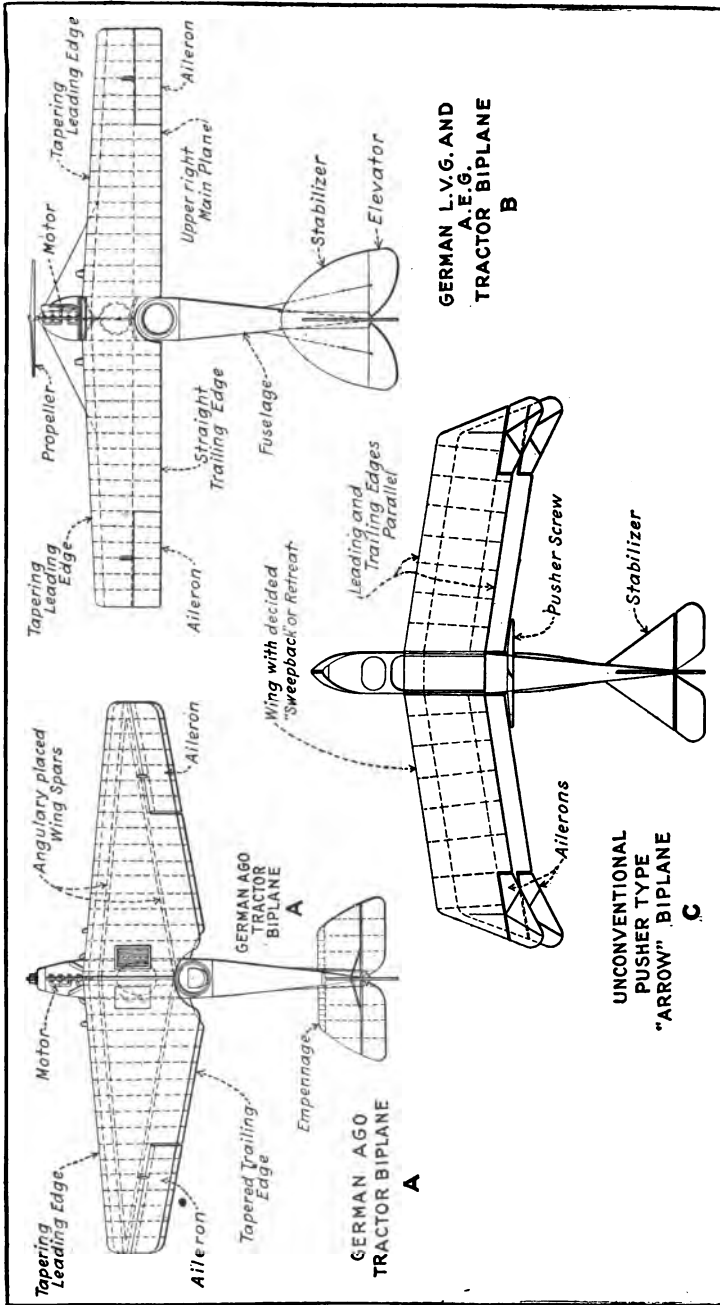


Fig. 44. A Comparison of Three Modern Types of Rather Curious Design. Those Shown at A and B are of the Tractor Type, While That Shown at C is of an Unconventional Pusher Type.

are modified to meet practical conditions may be clearly ascertained by referring to Figs. 43 and 44. The plan at *A*, Fig. 43, is a typical training biplane which has both a pronounced forward stagger and an overhang as well, and the upper and lower planes have a decided retreat or "sweep back." The function of this is to give a certain inherent stability under the influence of side gusts as will be explained later. It will be observed that the ailerons or balancing flaps are larger at the tip of the wing and that, when in the normal flying position, the wing has a greater chord at the tip than it has nearer the airplane body. The function of this swelling out of the ailerons is to provide more surface in order to compensate for the lessened lifting influence due to eddy currents which exist around the wing tips.

If one compares the plan at *A* with the arrangement shown at *B*, Fig. 43, which outlines a very successful machine, it will be evident that all designers do not avail themselves of the aerodynamical advantages to be obtained by incorporating some of the finer points of design. The biplane shown at *B* has both upper and lower wings of the same spread and the leading edge of the wing is at right angles to the fuselage. Both upper and lower wings have the same spread and practically the same amount of surface and both are provided with balancing flaps or ailerons whereas the machine shown at *A* has ailerons only on the upper planes. It is evident that it is much easier to build a machine when planes of the same size are used, and the installation can be considerably stronger when the wings have no "sweep back" or retreat.

If one studies the plan views shown at Fig. 44, some unusual airplane forms may be seen. That at *A* is the German AGO tractor biplane and has wings of the very peculiar form depicted in which both leading edge and trailing edge taper from the fuselage toward the wing tip. The angularly placed wing spars actually meet at the wing tip and it is claimed for this design that not only are some of the advantages of the retreating wing plan obtained, but that a wing plan form that more nearly meets theoretical conditions than other form is secured.



Mention has been previously made of the advantages obtained by having the greatest chord of the wing near the fuselage and having a decreasing chord toward the wing tip. In the form shown at *B* the wings have a tapering leading edge so that the effect of a retreat is obtained to a slight extent at that point, but there is a straight trailing edge which is at right angles to the center line of the fuselage which would seem to entirely nullify any supposed advantage gained by the tapering leading edge.

All of the machines shown and thus far discussed have been of the tractor type with the propeller or air screw mounted at the front end of the fuselage. A distinctive and unconventional type, which is shown at *C*, Fig. 44, has a pusher screw located back of the wings, but at the same time follows the usual construction in which an entirely covered-in streamline body is used instead of the usual open-work or outrigger construction which is necessary to carry the empennage in the usual pusher type. While the wings of this machine are set with the decided sweep back or retreat, a pronounced stagger is also provided. The ailerons, or balancing flaps, are placed on both upper and lower wings and are of the form that are enlarged near the tip, instead of the usual simple type, such as shown at *B*.

A study of the various designs, shown at both Figs. 43 and 44, will show that various designers have different opinions regarding the best plan form for the empennage members. Some of the stabilizers have gracefully rounding sides, while others are approximately triangular in form. There is also some difference in the form of the elevator flaps, but there is not much difference in the area provided for these surfaces relative to those of the main aerofoils. Very little is being done at the present time with unconventional plane forms, because practically all of the development work is being concentrated on the improvement of the power-plant. Almost any type of airplane will fly if it is given power enough, regardless of the shape or arrangement of the supporting and auxiliary surfaces if standard aerodynamical principles are not departed from too greatly.

## PLANES WITH LONGITUDINAL DIHEDRAL

Practically all airplanes at the present time are provided with stabilizing and control surfaces at the rear of the main supporting members, but some airplanes have been built in which the elevator has been placed at the front, but this is no longer considered good practice. While it was satisfactory with airplanes of early design that had relatively low speeds, the defects of this system were made apparent as soon as the airplane had been developed to a point where greater speeds were obtained. There have been types of airplanes developed that possessed no stabilizing surface as distinct from the main supporting surfaces and in these the arrangement of the main planes was in a pronounced V or the planes were given an exaggerated retreat or sweep back, which is sometimes called a longitudinal dihedral, which was said to assist in making such a design automatically stable. With this form it is necessary to give a decreasing angle of incidence toward the wing tips and also to change the camber of the wing from the center section to the tips. The function of the wing tips is then such that they act as longitudinal stabilizers.

One of the disadvantages of this construction is that it is a more difficult form to build than the conventional design, which in plan has supporting surfaces in the form of a parallelogram. In order to secure strength the wings must be considerably heavier. Another disadvantage is that the aspect ratio is not as large as would be the case if the leading edges of the wings are placed at right angles to the center line of the fuselage. Any airplane having a pronounced sweep back has a lower aspect ratio than the usual construction would have with the same length of leading edge, and as the efficiency of the lift decreases with a lessened aspect ratio, the V wing arrangement would produce less lift for a given weight of supporting surface than would be the case if the wings were arranged approximately in the form of a parallelogram as shown at Fig. 43 *B*, instead of having a pronounced retreat as outlined at Fig. 44 *C*. It is evident that the decreasing camber of the wings can be obtained only by using ribs of

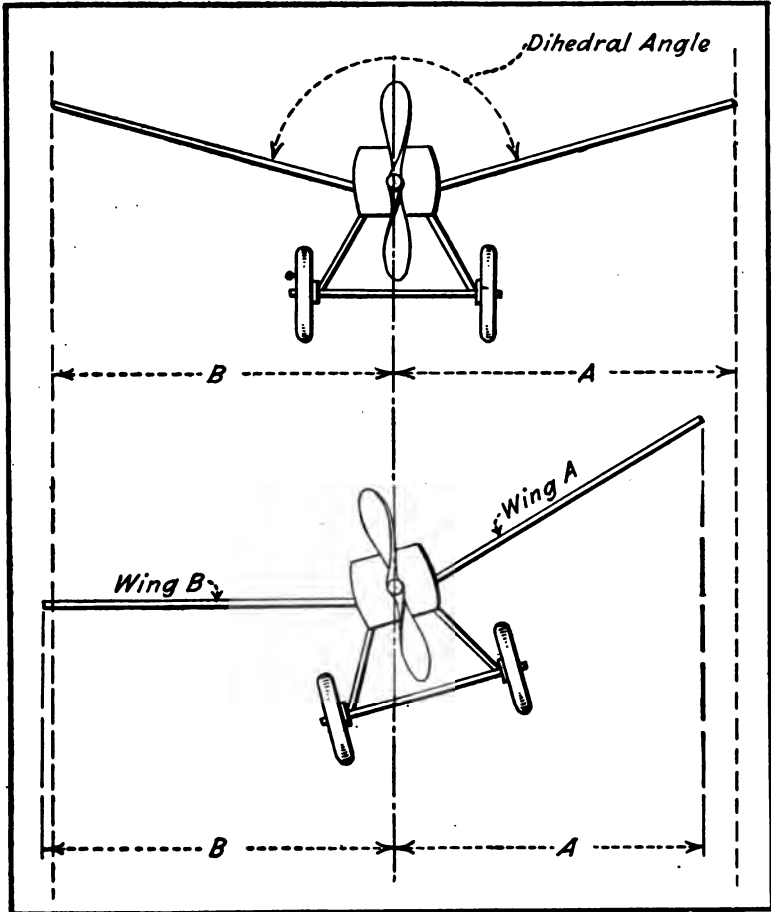
different forms at various portions of the wing and that this results in added expense. The longitudinal dihedral is not used to any extent at the present time because its theoretical advantages do not balance the practical and structural disadvantages inherent with this design.

#### INFLUENCE OF LATERAL DIHEDRAL

While the longitudinal dihedral is not used to any great extent the lateral dihedral has been applied in many designs because it aids in securing lateral stability. A dihedral angle is obtained by inclining the supporting surfaces up from the center of the fuselage so that the wing tips are higher than the other portions of the wing. A monoplane having a pronounced and somewhat exaggerated lateral dihedral is shown at the top of Fig. 45, under normal flying conditions. Just as is the case with the longitudinal dihedral, the effective span or wing spread is not represented by the actual length of the leading edge, but by projected distances *A* and *B*, which are termed "horizontal equivalents." It will be observed that under normal flying conditions, the distance *A* is equal to the distance *B*. This, of course, results in the lift of one wing being equal to that of the other. If, however, a gust of wind causes one side of the machine to tip, as is shown in the lower part of Fig. 45, it will be apparent that the horizontal equivalent of the lowest wing which is shown in a horizontal position and which is represented by the letter *B* becomes greater than that of the other wing as represented by the distance *A*. The wing *B* will have a greater lift than wing *A* and therefore will tend to rise while wing *A* will depress until the normal flying position is reached.

While the automatic stabilizing effect is not directly proportional to the difference between the horizontal equivalents *A* and *B*, and while other factors, such as amount of keel surface and disposition of the center of gravity, affect the automatic recovery, at the same time the lateral dihedral offers some advantages. Experiments in the wind tunnel have shown that moderate dihedral angles up to 14 degrees included angle, or 7 degrees angle at each wing, do not reduce

the aerodynamical efficiency appreciably and at the same time some degree of automatic lateral stability is secured. A well-known training machine of the tractor biplane type has a lateral dihedral of 4 degrees on each wing or a total included



**Fig. 45. A Monoplane Having a Somewhat Exaggerated Lateral Dihedral.**

angle of 8 degrees between the two. This means that instead of the wings being placed 180 degrees from tip to tip as would be the case if they were absolutely horizontal, the space between wing tips would be 180 plus 8 degrees if measured from underneath and 180 minus 8 degrees if measured from the top.

## AIRPLANE WING BRACING

If considered purely from an aerodynamic point of view the monoplane has decided advantages and is a more efficient form than the biplane, but as has been outlined in a previous discussion of this subject the reduced efficiency of the biplane is more than compensated for by the increased strength of the biplane structure. The advantages of the biplane are so firmly established at the present time that this type of machine is almost universally used. The first biplane forms were poorly designed and had so much exposed wiring and struts of such clumsy form that it offered considerably more resistance than the smaller and lighter monoplane did. The latter offered less resistance because it had no struts and was enabled to operate with higher efficiency because there was no interference between upper and lower surfaces as is the case with the biplane. Improved design and careful bracing have made it possible to build biplanes that are very fast and that are able to lift heavier loads than a monoplane of the same effective area.

As the size of machines increases the biplane structure offers greater advantages. We have seen that the construction of a wing consisted of two wing spars which were joined together by transverse ribs. The connection of the wings to the fuselage of the airplane is at the inner end of the wing spars so that we can consider one side of any airplane as a cantilever beam. The two methods of bracing the monoplane are shown at Fig. 46 *A* and *B*. The flying wires, which are those that assist the wing in carrying the load by transmitting some of it to the fuselage, are indicated by solid black lines while the landing wires are indicated by dotted or broken lines. The scheme shown at *A* is the most common one as the construction outlined at *B* has been practically abandoned. The biplane structures which are shown at Fig. 46 *C* and *D* may practically be considered true girders of the box or trellis type. As is true in the preceding example, the flying wires are indicated with solid black lines, while the landing wires are shown by broken lines. By these comparisons it can be seen that the biplane system may be so worked out as to offer a stronger and more rigid construction than is possible with a monoplane system, weights and supporting surfaces being equal.

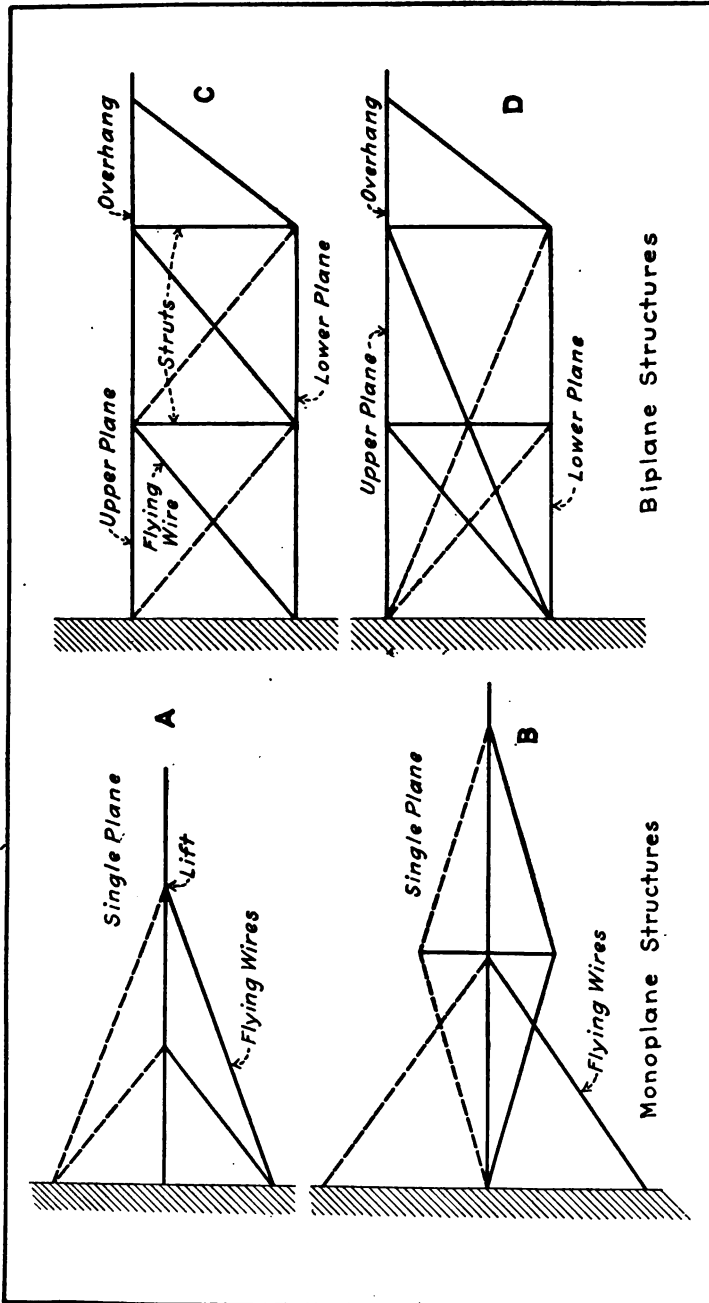


Fig. 46. Diagrams Showing Four Typical Wing Structures, Illustrating the Methods Employed in Bracing Each Type.

## SIDE BRACING OF AIRPLANE WINGS

The side bracing of airplane wings can be done in many different ways and there are many possibilities in the design of the interplane struts by which the usual wire bracings, which are called "incidence" wires, may be dispensed with entirely. The most common systems are shown at A and B, Fig. 47, and are based on the same principle, the difference

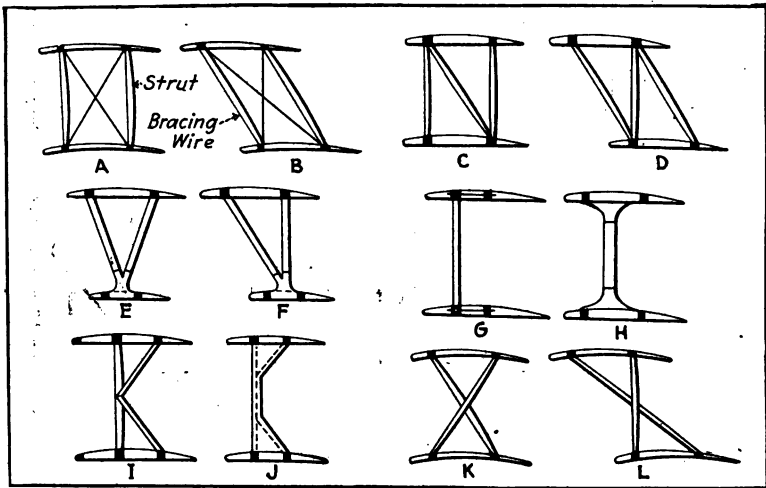


Fig. 47. Showing Several Methods of Bracing Biplane Wing Structures, and Illustrating the Function of the Struts in Each Case.

being that the form at A is adapted for a biplane having its leading edges parallel while that at B has a positive or forward stagger. Naturally, the struts must be inclined in the design shown at B. The construction shown at C is known as the N-type bracing, and at D its application to a staggered biplane construction is shown. It is stated that the use of three struts offers less resistance than two struts and two wires do. In fact, it has been proved that the resistance of the wires in the design shown at A or B will be reduced about 50 per cent. if the construction shown at C or D is adopted.

The bracing system depicted at F shows the V-type bracing which has been adopted on some of the Nieuport fast scout biplanes. The converging struts are assembled in a special streamline socket fitted between the spars of the lower wing,

and while it is also adaptable to the usual biplane form as shown at *E*, its field of greatest utility lies in the unequal chord biplane having a pronounced forward stagger. In the early days, Breguet designed a single lift truss biplane of the form shown at Fig. 47 *G*. As his main object was to vary the angle of incidence of the wings automatically, these were hinged to tubular spars and a spring bracing member having some degree of flexibility extended from the tubular spar to the rear spar of the wing. This construction brought the spars considerably nearer together than they would be in the conventional design wing and the entire structure was not as strong as the other designs employing double lift truss construction.

The *I*-type side bracing that has been used in an effort to reduce parasitic resistance is shown at Fig. 47 *H*. In this construction special sockets are used which have long bases reaching from the front to the rear spar, and these project from the wing surface an appreciable distance in order that the single strut will project into the socket far enough to secure the necessary strength and rigidity. The Martin *K*-type side bracing, which is shown at Fig. 47 *I*, has many advantages, and while it offers but little more resistance than the *I*-type shown at *H*, it eliminates the bending moments due to the cantilever socket construction. A modified system of the *K*-type side bracing is shown at Fig. 47 *J*. This is a single lift truss designed by Curtiss and built up of two steel tubes, one of them being bent in such a form that it can be readily fastened to the front strut for an appreciable length. When either of the *K*-type side bracings are used it is possible to streamline them so effectively as to secure a marked reduction in resistance. The *X*-type side bracing, which is shown at Fig. 47 *K* and *L*, is not used to any extent at the present time, though it would seem to offer some advantages over the conventional construction shown at *A* and *B*, because it eliminates the bracing wires.

#### AIRPLANE BRACING WIRES

Two kinds of steel wire are used for bracing, one being a hard wire, while the other is a flexible cable or steel rope. The stay wire loops and the method of forming eyes in both



flexible cables and hard wire by the use of thimbles, around which the flexible cable is bent and afterwards securely held together by a serving of soft steel or copper wire well soldered, is shown at Fig. 48. The hard wire loops are made by using oval coils of wire as sleeves and bending up one end of the wire as shown, afterwards soldering the whole to insure that the parts will stay in the proper relation. In order to insure that the bracing and stay wires will be properly tightened, turn-

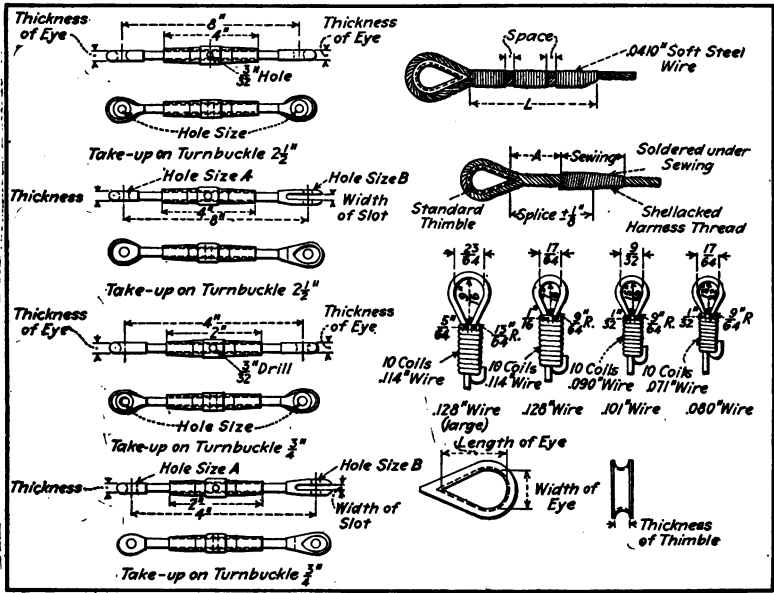


Fig. 48. Details of Standardized Thimbles and Turnbuckles.

buckles are interposed in each wire. These may easily be tightened by inserting a pin in the turnbuckle body and, after the cables have been tightened to the proper degree, the turnbuckles are "safety wired" by passing copper or soft iron wire through the turnbuckle body and then wrapping it through and around the eyes in such a way that the turnbuckle body cannot become loosened without the safety wire being cut and removed. This renders it impossible for a cable to become loose due to vibration while the machine is in flight. The appended data regarding the various cables and hard wire, as well as the turnbuckles generally used in airplane wire bracing

work, has been suggested by the Aeronautic Division of S. A. E. This gives sizes and strength of wires of various kinds.

**Hard Wire Loop.**—This consists of an oval coil of wire through which the hard wire is slipped, bent in the form of a loop, again inserted, and the end bent over against the coil. The whole is then soldered. This is identical with the present British standard.

**Flexible Cable Ends.**—The sketch shows the cable end wrapped around a "standard thimble." The length of splice from pointed end of opening in thimble was represented by "splice plus or minus  $\frac{1}{8}$  inch." The end of the splice is wrapped with a serving of shellacked harness thread. Dimension *A* represents the distance from end of opening in thimble to end of serving.

Diameter of Cable	Length of Splice	Number of Tucks	Length of Serving	Full Strength of Cable
$\frac{5}{32}$ 7 x 14....	$1\frac{1}{4}$	3 over core buried	1	$\frac{1}{2}$ 800
$\frac{1}{8}$ 7 x 19....	$1\frac{1}{2}$		1	$\frac{1}{2}$ 2900
$\frac{5}{32}$ 7 x 19....	$1\frac{3}{4}$	4 under	$1\frac{1}{4}$	$\frac{1}{2}$ 2800
$\frac{3}{16}$ 7 x 19....	$1\frac{7}{8}$		$1\frac{1}{4}$	$\frac{3}{4}$ 4200
$\frac{7}{32}$ 7 x 19....	$2\frac{5}{8}$		$1\frac{1}{4}$	$\frac{3}{4}$ 5600

**Galvanized Non-Flexible Ends.**—The cable end is wrapped about a thimble, with a total length of splice indicated by *L*; 0.041 inch soft steel wire is to be used for wrapping, and the sketch indicates two spaces left between convolutions of the wrapping wire, width of the spaces being indicated in the table. The accompanying table gives the sizes and strengths:

Diameter of Cable	L	Space	Wind	Full Strength of Cable
$\frac{1}{16}$ 1 x 19.....	$1\frac{1}{2}$	$\frac{1}{8}$	1	500
$\frac{3}{32}$ 1 x 19.....	2	$\frac{1}{8}$	$1\frac{1}{4}$	1100
$\frac{1}{8}$ 1 x 19.....	$2\frac{1}{2}$	$\frac{1}{8}$	$1\frac{1}{2}$	2100
$\frac{5}{32}$ 1 x 19.....	$2\frac{3}{4}$	$\frac{1}{8}$	2	3200
$\frac{3}{16}$ 1 x 19.....	3	$\frac{3}{16}$	$2\frac{1}{4}$	4600
$\frac{7}{32}$ 1 x 19.....	$3\frac{1}{2}$	$\frac{3}{16}$	$2\frac{1}{4}$	6100
$\frac{1}{4}$ 1 x 19.....	4	$\frac{1}{4}$	$2\frac{1}{2}$	8000

**Thimbles.**—These thimbles are shown by appropriate drawings. The sizes are indicated roughly by the following table:

Size of Rope	Thickness of Thimble	Width of Eye	Length of Eye
$\frac{1}{16}$ - $\frac{3}{32}$ .....	0.075	0.35	0.70
$\frac{1}{8}$ .....	0.12	0.35	0.70
$\frac{5}{32}$ .....	0.17	0.40	0.80
$\frac{3}{16}$ .....	0.21	0.50	1.00
$\frac{7}{32}$ .....	0.24	0.60	1.20
$\frac{1}{4}$ .....	0.27	0.70	1.40
$\frac{9}{32}$ .....	0.30	0.80	1.60
$\frac{5}{16}$ .....	0.33	0.90	1.80
$\frac{3}{8}$ .....	0.39	1.00	2.00

**Turnbuckles.**—Detail dimensions of both short and long types are given in Fig. 48. The following main dimensions are recommended for immediate adoption:

(With either two eye ends or one eye and one yoke end.)

	Short	Long
Length of barrel.....	2	4
Length between eyes:		
With threads flush with ends of barrel.....	4	8
With maximum extended.....	$4\frac{3}{16}$	$8\frac{3}{16}$
With minimum extended.....	$3\frac{1}{4}$	$5\frac{1}{2}$

Strength (Lbs.) S. A. E. Numbers	Short	Long
1.....	500	500
2.....	1000	1,000
3.....	1500	1,500
4.....	2000	2,000
5.....	2500	2,500
6.....	3000	3,000
7.....	3500	3,500
8.....	.....	4,000
9.....	.....	4,500
10.....	.....	5,000
11.....	.....	6,000
12.....	.....	7,000
13.....	.....	8,000
14.....	.....	9,000
15.....	.....	10,000

TYPICAL WIRE BRACING ARRANGEMENTS

The arrangement of bracing wires on a number of airplanes of different design is given at Fig. 49, so that the student may determine the various kinds of bracing ordinarily used. The simplest construction is shown at A. In this, the overhang

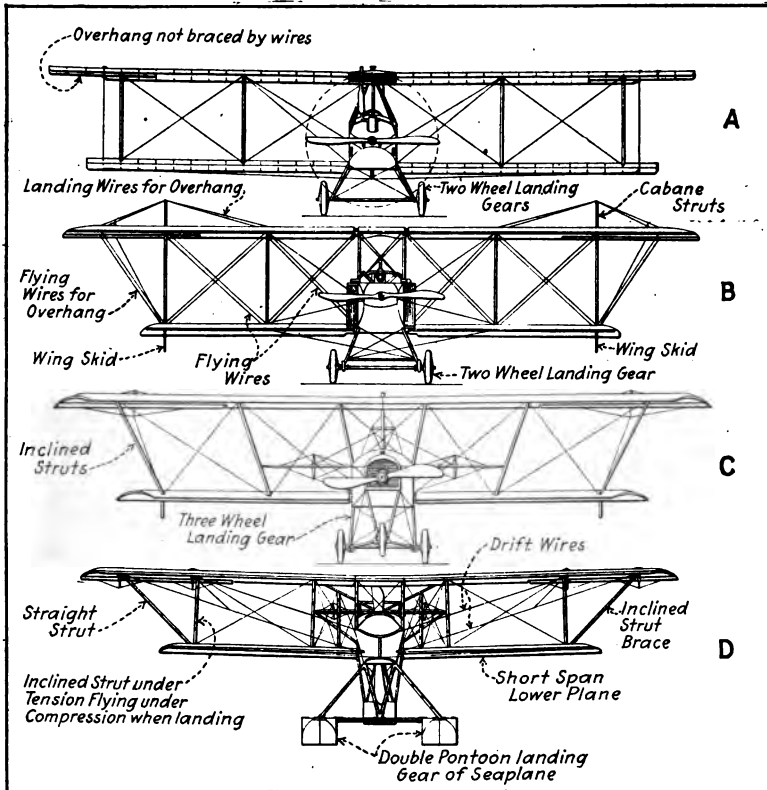


Fig. 49. Showing Arrangement of Bracing Wires on a Number of Airplanes of Different Design.

of the top plane is not braced by any wires and all of the strain produced by the lift while flying or the reverse load when landing must be taken entirely by the wing spars. In the tractor biplane, shown at B, the overhang is braced by flying wires which extend from the bottom of the outside strut to the wing spars. The overhang is also braced by landing wires

which are stretched over cabane struts on the top of the upper plane. In the tractor biplane, shown at *C*, the struts are inclined instead of being straight up and down as in the form shown at *A* and *B*. The difference in landing gear construction and bracing can also be easily determined from these illustrations. Two-wheel landing gears of simple form are used on the planes shown at *A* and *B*, while a three-wheel landing gear of somewhat stronger construction that also offers more resistance is shown at *C*. The seaplane shown at *D*, Fig. 49, has the overhang braced by an inclined strut which is under tension while flying and under compression when landing. The arrangement of the drift wires which extend from the front of the fuselage to the wings is also apparent. It will be observed that the wings of the seaplane are set at a slight dihedral angle and that the pontoon landing gear must offer considerably more resistance than the simpler wheeled landing gears of the land machines.

## CHAPTER VI

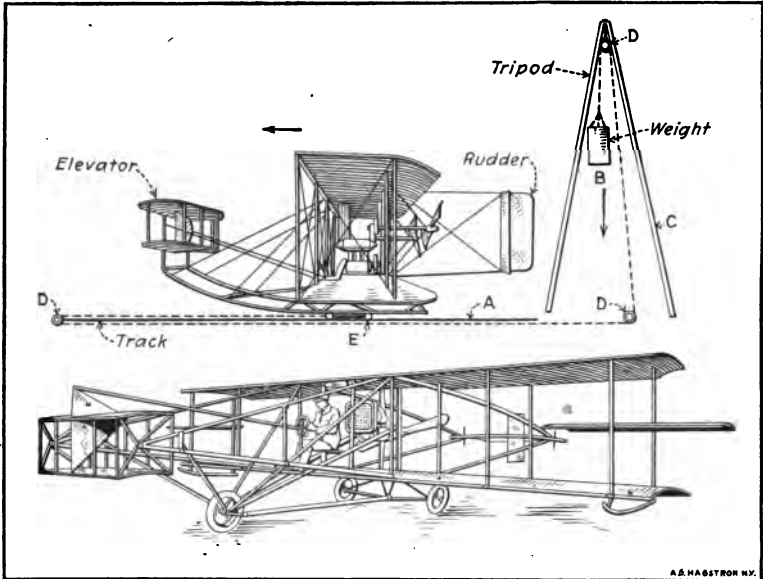
### AIRPLANE FUSELAGE CONSTRUCTION

Early Wright Starting System—Design of Fuselage Framework—Airplane Design Considerations—Reduction of Parasitic Resistance—Airplane Fuselage Forms—Complete Inclosure Important—How Coincidence of Centers is Obtained—Landing Gear Forms—Wheel Tread Depends on Spread—Woods for Airplane Parts—Metals Used in Airplanes—Table 8—Table 9—Table 10.

WHEN airplanes were first designed the type of construction followed was to use the wing structure as a main framework which carried the aviator, the power-plant and the propulsive screws while control and stabilizing surfaces were carried by outriggers and in a number of the early biplane designs the controlling surfaces were placed at both front and rear of the wing structure. In the construction that was first followed in the Bleriot monoplane, the power-plant was carried at the front of the machine and was mounted in a framework or body which served to carry most of the weight, inasmuch as the tanks for fuel and the seat for the pilot were included in the fuselage. With the tractor monoplane type of construction the control surfaces were carried at the back end of the machine and no control members were placed at the front end. The advantages of this construction were so marked that the older form was discontinued and practically all machines, whether of the single plane or multiplane type, were designed on the early monoplane principle of having the wing sections attached to a fuselage which carried most of the weight and the control surfaces instead of the type that offered the most resistance in which practically all of the weight was carried directly by the wing structure.

Two early biplanes are shown at Fig. 50. That at the top is the historic Wright creation with which the possibilities of mechanical flight were first demonstrated to an unbelieving scientific world. The type shown below it is a Curtiss creation that did some wonderful work for the early days and which

proved to be not only a very reliable type, but one in which the qualities of safety were best developed. It will be observed that there was considerable difference in the design of these two pioneer forms. The Wright machine had its power-plant carried on the lower plane, and at one side of the seat occupied by the pilot, which was also on the lower supporting surface. The drive was by chains to two large diameter, relatively slow,



**Fig. 50. Two Early Biplanes, That at the Top being the Historic Wright Machine Which Demonstrated the Possibilities of Mechanical Flight. The Lower One is an Early Curtiss Machine of Remarkably Dependable Characteristics.**

speed pusher screws. In the Curtiss machine the power-plant was placed back of the aviator and mounted approximately in the center of the gap so that the propeller thrust came about half-way between the upper and lower wing surfaces. In this machine the power transmission system was very much simplified by having the propeller directly connected to the engine crankshaft and revolving it at engine speed.

Another marked difference was in the method of securing lateral stability, as in the Wright machine the wing tips were made flexible, and it was possible to warp them so that the wing

curvature at the tip and for a certain distance toward the center was changed so that on the high wing one had a decreased curvature and a lessened lift, while on the low wing one had a more pronounced camber and a correspondingly increased lifting effect. In the Curtiss biplane lateral stability is secured by means of small auxiliary wings or ailerons attached to one of the wing spars and so connected to a shoulder yoke that the pilot could incline his body toward the high side of the machine and by so doing regulate the position of the aileron on the high side so as to give a depressing action, while that on the low side was tilted so that a lift on the under surface would give a greater lifting effort and consequently tend to right the machine. In both of the early biplanes shown, the elevator was in the form of a small biplane structure and was carried by outriggers at the front end of the machine. The vertical rudders by which the machines were steered from side to side were carried at the back in both types.

The most marked difference in which the two pioneer types of airplanes differed and which had a material bearing on the design was in the matter of starting. The early Wright machines used a system of launching the airplane which permitted it to rise in a preliminary run of a little less than 75 feet, but it involved a rather elaborate launching mechanism, and if the airplane landed at a point remote from the launching gear it could not ascend again. The foreign designers and Curtiss in this country believed that the wheel type landing gear would be the most practical even if it did involve a run of several hundred yards over the ground before sufficient flying speed was obtained to enable the airplane to rise in the air. The system originated by the Wrights is not used at the present time in connection with land machines, but is utilized in a modified and improved form for launching seaplanes from the decks of ships. Even the Wright Brothers soon changed their construction to a combined wheel and skid landing gear.

#### EARLY WRIGHT STARTING SYSTEM

The form of starting apparatus adopted by the Wrights on their first creation depended upon the rapid acceleration



given by a falling weight. The airplane was mounted on a small wheeled truck which ran on a track. A rope was attached to the truck and ran through sheaves and over a pulley, supported on a high tripod, and a heavy weight was attached to the rope, so that when it was released and fell, it would draw the small truck along the track and the airplane would be travelling at sufficiently high velocity by the time it reached the end of the track, so that the revolving air screws were delivering enough thrust to lift the machine into the air. With this construction it is possible to use skids for an alighting gear which form part of the framework of the airplane. Another thing made possible by this method of launching was the fact that a smaller amount of surface and a reduced engine power was necessary to secure flight. This type of construction was not encouraged because with wheels one is independent of starting platforms, rails, or catapult launching devices, and for this reason the wheel landing gear became universally applied and is now used on all land machines.

One of the advantages brought up for the skids was that they acted as a brake and retarded the airplane movement after it touched the ground, whereas the wheel form did not enable the aviator to make a quick landing. This resulted in a number of landing gear designs in which wheels and skids were combined, though these gears weighed more than the types in which wheels alone were used. In the early Curtiss machines the motion was arrested by a simple spoon brake actuated by the foot and working on the tire of the front wheel, this serving to arrest motion over the ground soon after the plane alighted. In the early Curtiss machines no shock absorbing means other than that provided by the resiliency of the tires was incorporated in the construction. In the first Bleriot monoplanes, which were so efficient a flying machine that their construction is followed in many respects in the later types of planes, the two-wheel alighting gear was provided with shock absorbing means in the form of coil springs on the early machines, which construction was afterward modified to use shock absorbers of rubber. A discussion of some of the modern type of alighting gears to follow will show how these

gears have been simplified, strengthened and improved in action.

#### DESIGN OF FUSELAGE FRAMEWORK

One of the disadvantages of either of the machines shown at Fig. 50, in which the power-plant was placed either at the side or in back of the aviator, was that in event of a rough landing, which was much more common in the early days than it is at the present time, the aviators were very often fatally injured by having the power-plant fall on top of them



Fig. 51. Captain Victor W. Pagé, Aviation Section, S. R. C., U. S., Seated in Rear Cockpit of Modern Tractor Biplane Showing Degree of Protection Offered and Space Available for Pilot.

in nearly every smash. It was soon discovered that the system of construction employed on the Bleriot monoplane had the marked advantage of making a machine "nose heavy" and that in most rough landings the position of the power-plant was such that it fell clear of the aviator in event of a smash and that a considerable degree of protection was afforded by the landing gear and supporting framework.

One of the most important parts of the modern airplane is the framework supporting the sustaining surfaces and employed to carry the greater part of the weight, such as the power-plant and the useful load. The problem of building a fuselage or frame sufficiently light for use in airplanes where every ounce must be accounted for, while at the same time it would possess the strength and endurance essential for this work was not difficult of solution because light and strong materials were available that were particularly well adapted to airplane framework construction.

The form of the machine has a material bearing upon the general lines of construction as will be evident by examination of the airplane types shown at Fig. 50, when compared to those shown at Fig. 54. In the modern construction the fuselage is the main member from which the surfaces extend, and in the modern monoplane the fuselage may be compared to the body of a bird and the aerofoils to the wings. It was soon learned, as a result of the wind tunnel experiments, that air resistance was materially less when the closed-in fuselage frame was used instead of the open framework and outriggers provided in the early forms of biplanes. A reduction in air resistance made greater speed possible with the same power and reduced the supporting surface necessary to secure sustentation.

#### AIRPLANE DESIGN CONSIDERATIONS

In designing any form of airplane or component thereof the designer must have certain basic principles in mind. These were stated in the writer's first treatise on aerial navigation published about ten years ago, and are still applicable to the design of modern forms. The following are principles which should be observed in designing or building airplanes:

1. An airplane must have sufficient combined speed, power and plane area to raise a useful load in addition to its own weight. The greater the amount of useful load lifted for a given engine power the greater the efficiency of the airplane.

2. The greater the speed of flight the less the plane surface required and the smaller the necessary angle of incidence of that plane for carrying the load.

3. To counteract the resistance set up by the means of gaining momentum while on the ground, which is additional to the resistance the machine will have when once it is clear of the ground: (a) extra power is required or (b) extra plane surface to meet the power available or (c) a better lifting effect for the plane area and power we have available or (d) an outside agency that will assist in launching the plane. Though extra power means more weight and extra supporting area means more resistance, the modern airplanes nearly always have a large reserve of power, as it has not been possible to make many improvements in the present method of construction.

4. The supporting planes must always have sufficient area to permit a low and therefore a safe landing speed.

5. The shape, camber and angle of incidence to be employed depend upon the type of machine to be constructed and the means employed for obtaining lateral and longitudinal balance and stability. We have seen that a plane suitable for carrying heavy loads is not the form best adapted for high-speed work.

6. All parts of the machine should be constructed of as strong material as possible, and the design should be such that the part should create as little useless or parasitic resistance as possible. The general arrangement should be simple and the control should be easy of manipulation.

7. The machine should be so designed that it will be inherently stable to some degree; it should have an ample margin of safety and as large a gliding angle as possible.

**Reduction of Parasitic Resistance.**—One of the important points in which the modern airplane has been improved has been in the elimination of parasitic resistance. This has been accomplished by a careful study of air resistance on bodies of various forms made in the wind tunnel. While the action of air around a streamline body has been previously shown, it may be well to review the definition of this form of body. As shown at Fig. 52 A, a streamline body may be defined as one which when moving through a fluid or when a fluid is moving past it that does not cause a breaking up of the air stream nor produce any disturbance or eddy currents in its wake. It should be of such a form that the streamlines or

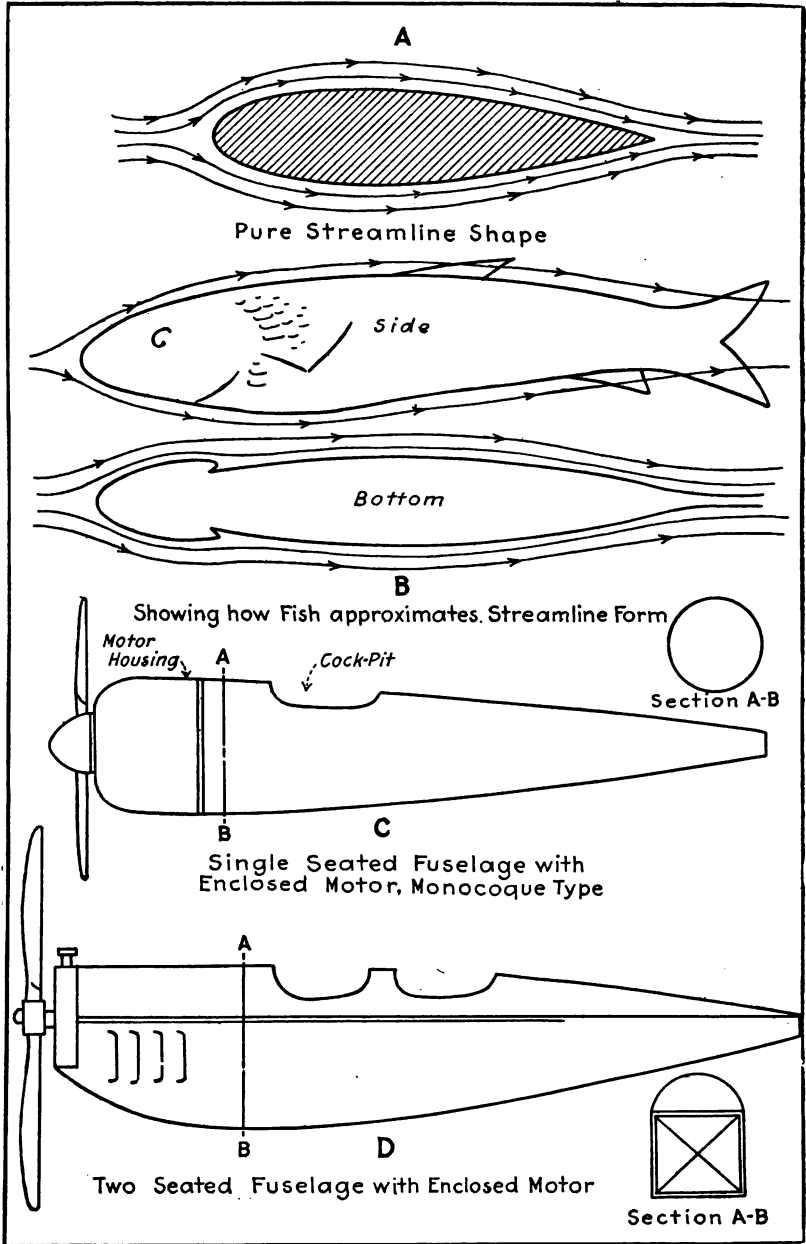


Fig. 52. Illustrating the Development of the Modern Fuselage from Studies Made of the Streamline Shape of the Fish.

air currents would be deflected in a gradual manner and which would merge in parallel streams at the rear of the body with practically no loss of energy.

Tests that have been made with bodies of various forms in water which, of course, offers considerably more resistance to the movement of a body through it than the air does, have demonstrated that nature has worked out very efficient streamline shapes which were found incorporated in the various species of fish. If one will refer to the illustrations at Fig. 52 *B*, which show the side and bottom views of a very fast-swimming fish, the trout, it will be observed that it follows very closely an ideal streamline shape as shown at *A*. An important consideration in the design of streamline form is in the fineness ratio. This is the ratio the total length bears to the greatest width. In the trout the length is from six to eight times the greatest width. Streamline bodies for use in air can be less fine than those intended to be forced through the water and at equal velocity.

Naturally, airplane designers plan the airplane fuselage with a view to approximating as nearly as possible an ideal streamline body which, however, had to be modified owing to structural considerations. The ideal shape for an airplane fuselage is that of a streamline body that has sufficient capacity to accommodate the engine, fuel tanks, aviators and the necessary accessories without being excessively wide. The fineness ratio of airplane fuselages of present-day types is about seven to one in the average example. This means that the fuselage is about seven times as long as its width at the widest part.

**Airplane Fuselage Forms.**—The airplane fuselage is made in two forms. In that shown at Fig. 52 *C* we have what is called the “monocoque” type and which has less resistance than any other form, and is therefore used on fast machines. In this the fuselage is approximately round in cross-section, its shape depending on the type of power-plant employed and the disposition of the power-plant with auxiliary parts. Experiments have shown that at 60 miles an hour a true streamline body measuring 3 ft. in diameter by 17 ft. in length would have a resistance estimated at about 7 pounds. The

usual airplane body resistance varies from 30 to 60 pounds at the same speed, and this is due to the structural requirements in the modern airplane which called for radiators in an exposed position, wind deflectors and a departure from the true streamline form on account of having to carry a pilot and a passenger. The fuselage at Fig. 52 *D* shows the form of fuselage provided on practically all two-place machines. A fuselage of the single-seated "monocoque" type having a revolving motor in a rounded housing might have a resistance of about 30 pounds. That of a two-place fuselage such as shown at Fig. 52 *D* might run up to 60 pounds. The greater resistance makes the form of fuselage shown at *D*, a type that is adapted to moderate speed machines, while the monocoque body construction shown at *C*, due to its offering about half the resistance, is the type used on high-speed, single-seat battling planes.

**Complete Enclosure Important.**—In the early days it was not thought necessary to enclose anything but the front part of the fuselage, as it was believed that the resistance of the open framework at the back would be negligible. Experiments

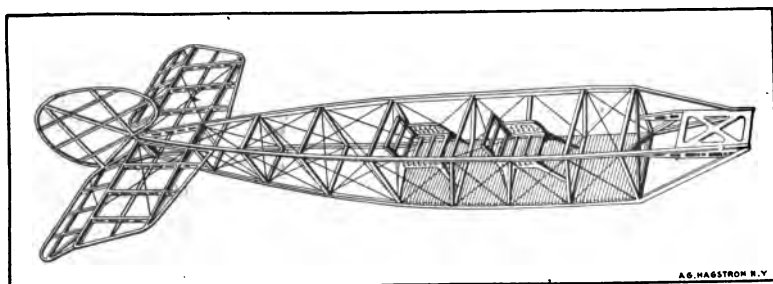


Fig. 54. Showing a Typical Fuselage Without the Covering and Illustrating the Methods Employed to Get Great Mechanical Strength with a Minimum of Weight.

soon demonstrated that there was a marked reduction in the resistance if the framework of the fuselage was entirely covered in with linen instead of only half covered. Typical fuselage forms with the covering removed are shown at Fig. 53 and Fig. 54. It will be observed that the fuselage consists essentially of four longerons or longitudinal frame members of ash





11

us  
at  
m  
in  
th  
pi  
fc  
A  
re  
of  
sl  
rt  
is  
b  
tl  
b

n  
o  
f

1

which are held apart by fuselage uprights of ash or spruce and kept separated by compression members of corresponding form. These wooden spacing and bracing members are attached to metal fittings and the entire structure is braced by cross wires. At the front end of the fuselage, where the greatest load is carried, the bracing is with flexible cable, while at the back end, where the section of the fuselage is smaller and where the load carried is less, single-strand or piano-wire braces are all that is necessary. The front end of the fuselage terminates in a steel stamping or spider which not only serves to tie all of the longitudinal frame members together, but which serves also as a radiator support and an anchorage for the front end of the engine bed timbers. In the fuselage, the uprights at that point in the frame where the greatest stress comes are of substantial proportions.

#### HOW COINCIDENCE OF CENTERS IS OBTAINED

An important point in the design of the airplane fuselage is the proper distribution of weighty parts and location of supporting surfaces to secure a proper coincidence of the important centers of gravity and pressure. The subject is covered in a very able manner by B. Russell Shaw, writing in *Aviation and Aeronautical Engineering*, who calls attention to some points in airplane design worthy of mention.

A procedure often poorly followed in designing an airplane is the correct balancing of the component parts and giving them the correct relation with the center of pressure.

Some designers draw the complete machine, locate the center of pressure and center of gravity, then give them the correct relation by shifting such weights as the pilot and passenger or the gasoline tank. This method is very poor, inasmuch as it does not allow the body struts and ties to be attached at the proper places. The gasoline tank should be given as nearly neutral position as possible, and not shifted.

The seats should not be moved, for once a proper and comfortable arrangement is reached that arrangement should remain, as any moving from this point may cause cramping in an unnatural position. The body should be laid out complete,

taking into consideration the range of vision of the pilot. If he is to be placed in front, as in some European machines, then the gunner in the rear seat must have ample room for action. It is sometimes an advantage to have two seats, one above the other, so that the top one may be folded up allowing him to sit almost on the floor of the body for observation, camera work or bomb dropping through a door in the floor.

The center of gravity of the entire body assembly is found by a very simple method shown in Fig. 55. The weights of the component parts are multiplied by their respective distances.

$$AA_1 + BB_1 + CC_1 + DD_1 + EE_1 + FF_1 + GG_1, \text{ etc.}, = \frac{W_1}{W}$$

The first distance  $A$  is anything desired.  $W$  = the total weight of all component parts in the body assembly.

After this is done the wings should be considered. They should be drawn upon a separate sheet and the resulting C.P. and C.G. determined, allowance being made for the extra efficiency of the upper plane affecting the combined location of the C.P.

The wings are then placed on the body and shifted until the desired relations of C.P. and C.G. are obtained. This will apply to a neutral tail setting. If a positive or negative tail is used, the forces actuated by it must be taken into account. The resulting forces caused by the leverage between the C.P. or  $K_v$  and the C.G. or  $W$ , as well as those between the lines of thrust and resistance, must be gone into very carefully when setting the tail plane so that the proper degree of longitudinal stability may be obtained.

#### LANDING GEAR FORMS

One of the important problems in connection with airplane design is in the selection of the best type of landing gear. As will be seen by reference to Fig. 56, the important consideration is to provide sufficient ground clearance so that there will be no danger of hitting the ground with a propeller when making a tail high landing. The tread or track must be sufficient so that the machine will be stable when running on the ground. At the same time the tread should not be so

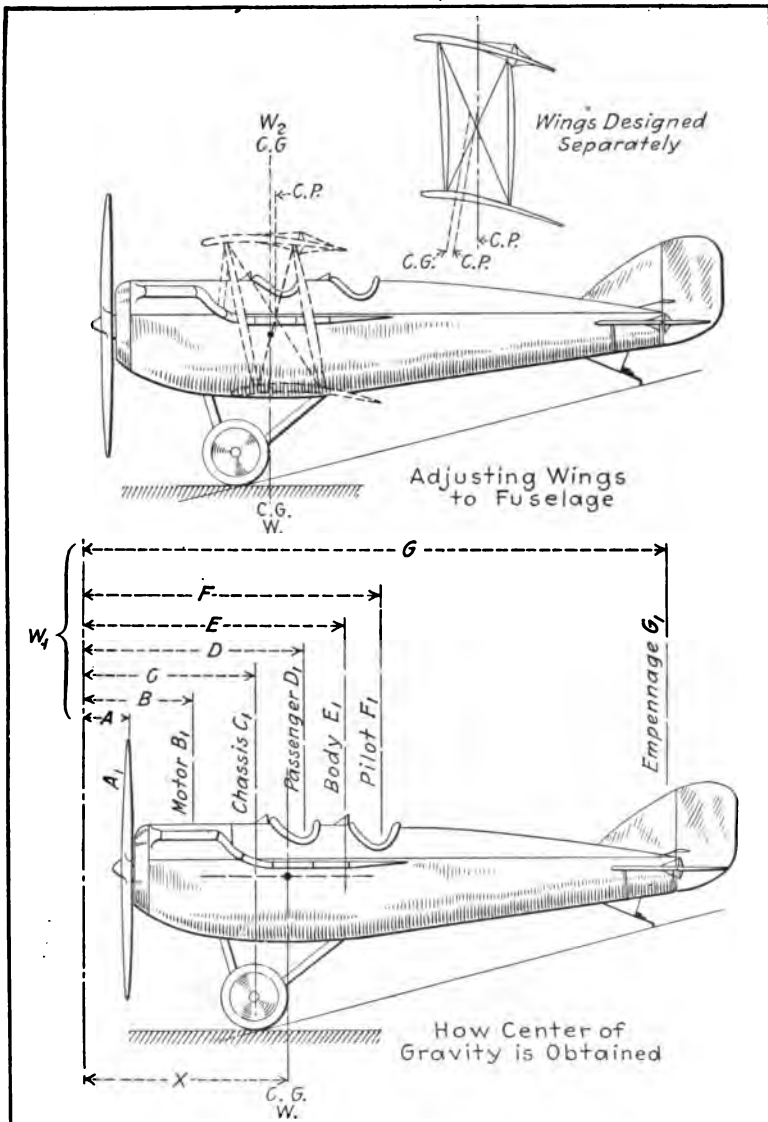


Fig. 55. Diagrams Showing Simple Method of Weight-Distribution in Airplane Design

great that the machine will be turned around by one wheel striking a soft spot or an obstruction in the ground when landing. The point of contact of the wheels with the ground must be so arranged in respect to the center of gravity of the machine that there will be no tendency for the machine to nose over when making a moderately tail high landing.

As will be seen at Fig. 56, a line drawn from the center of gravity to the ground when the machine is in its normal flying position should come well back of the point of contact of the landing gear wheels and the ground. This will result in the machine coming to rest with the tail skid on the ground

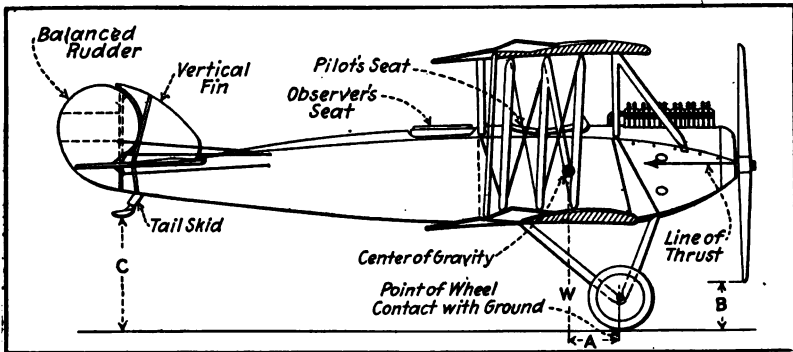


Fig. 56. The Relative Positions of the Center of Gravity and Point of Wheel Contact with the Ground.

instead of with the tail up in the air and the machine on its nose as will result from carrying the center of gravity or moving the axle so that the line *W* would coincide with the axle or touch the ground at a point ahead of where the wheel tires rest on the ground. With the ordinary form of rubber shock absorber an axle movement of four to six inches is provided, and this means that under normal conditions when the machine is standing on the ground and the shock absorbers are not extended, the distance should be at least one foot, which will give a clearance of about half that if the shock absorber rubbers are stretched to the limit.

**Wheel Tread Depends on Spread.**—The ordinary tread or distance between the wheels depends on the size of the machine

and the wing spread. Naturally, the greater the spread the wider apart the wheels must be. On machines having a spread in excess of 50 ft. it sometimes is the practice to provide two independent landing gears which may be spaced as much as 12 ft. apart. Sometimes the landing gear is a skid form having the skids separated by 10 or 12 ft. and having a short axle carrying two wheels which are 16 to 18 in. apart straddling the skid. Distance members are provided so that the wheels will track properly and the usual form of shock absorber cable is wound around the axle and the skid. The tread of the average tractor biplane ranging from 40 to 50 ft. spread will be about 6 ft. An empirical figure based on average practice would give a wheel track of about one-eighth the effective wing span.

Another factor that regulates the height of the landing gear besides that of propeller clearance is the maximum angle of incidence it is desired to attain or have the wings inclined at when the tail skid is resting on the ground. In order to obtain a short run after the machine lands, it is common practice to make a tail low landing and have the wings at an angle of incidence of 15 or 16 degrees. This, of course, would call for a very short tail skid if the landing gear was of moderate height or a higher landing gear if a really efficient tail skid was desired.

A number of types of modern landing gears are shown at Fig. 57. That at *A* is a conventional two wheel form, while at *B* a combined skid and wheel landing gear is shown. To prevent nosing over, on some training machines a three wheel alighting gear is sometimes provided, as shown at Fig. 57 *C*. The disadvantage of the three wheel landing gear is that it is a more complicated form than the two wheel gear which is so clearly shown at Fig. 53, and also that it offers more resistance when the machine is in flight. The machine shown at Fig. 57 *D* is an unconventional machine of the pusher screw type which has four wheels, as indicated. The disadvantage of the three and four wheel types is that the front wheels sometimes take the full force of the landing, and as they are not as large or braced as securely as the main wheels the landing

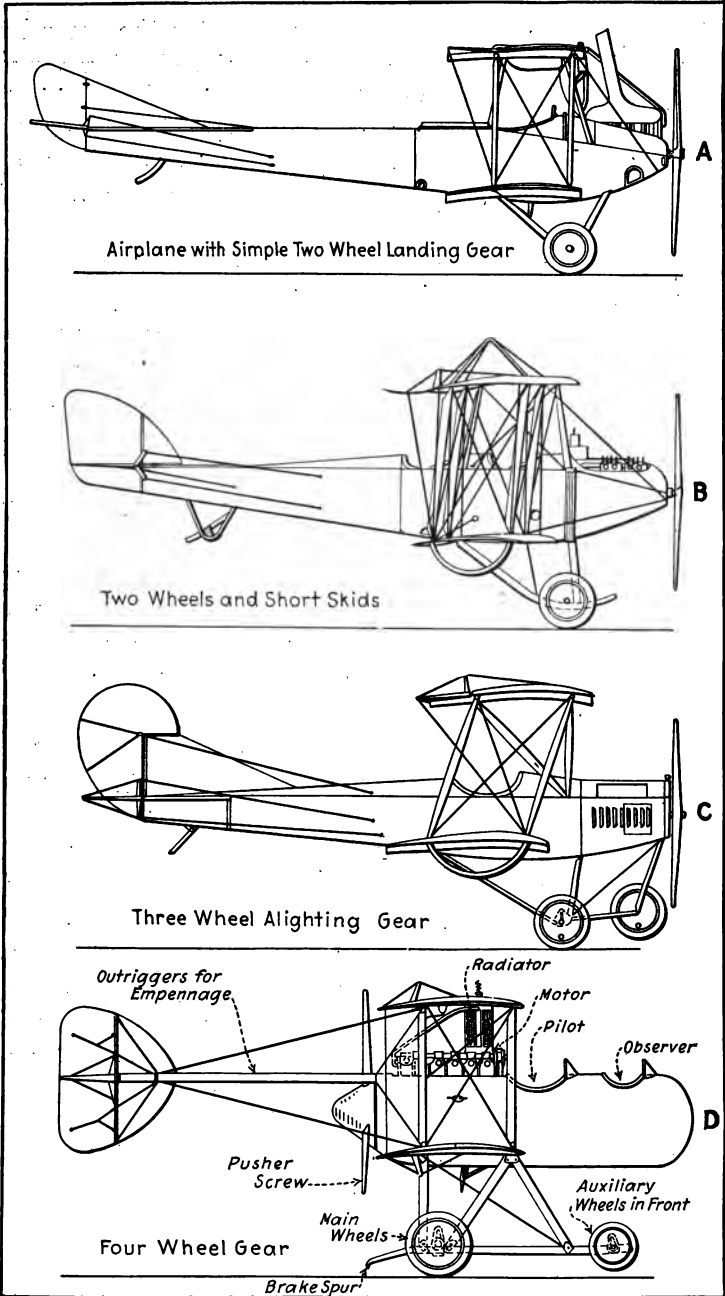


Fig. 57. Four Types of Landing Gears Showing the Various Designs Employed.

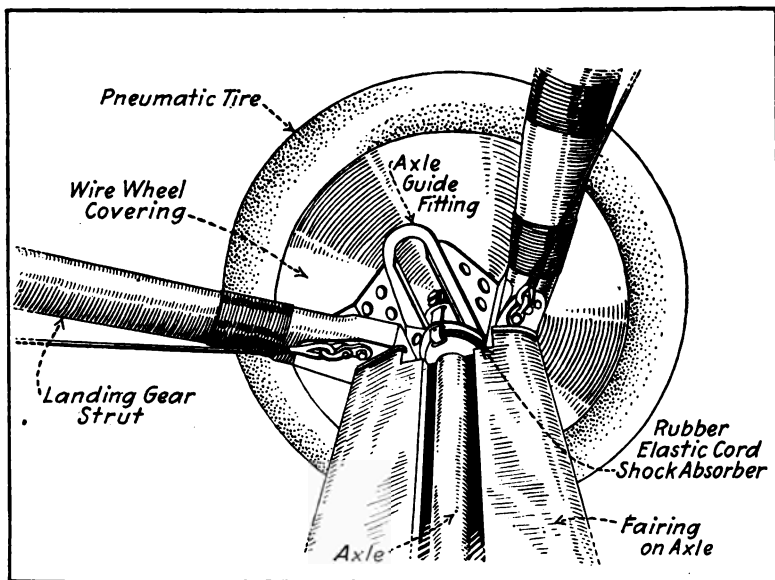


Fig. 58. Showing Wheel, Axle, and Shock Absorber Parts of Landing Gear Suitable for Medium Weight Airplane.

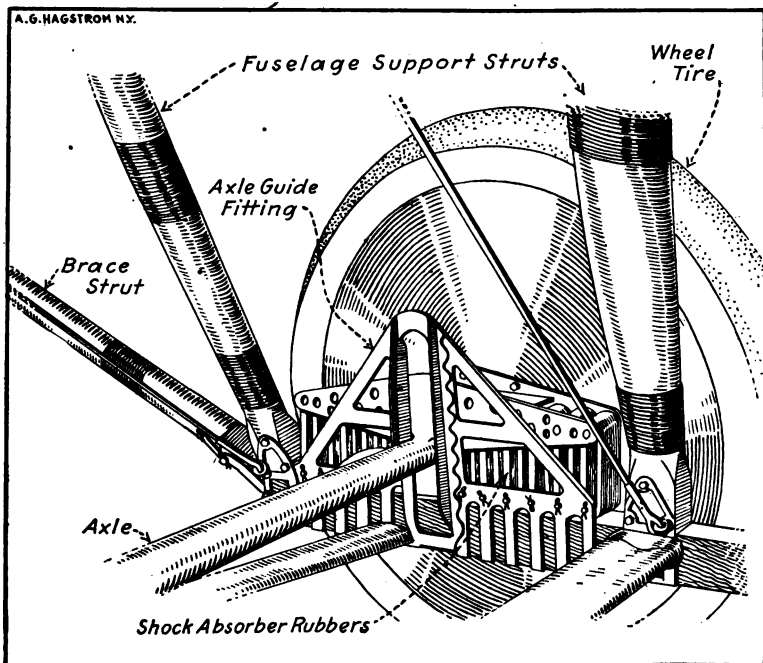
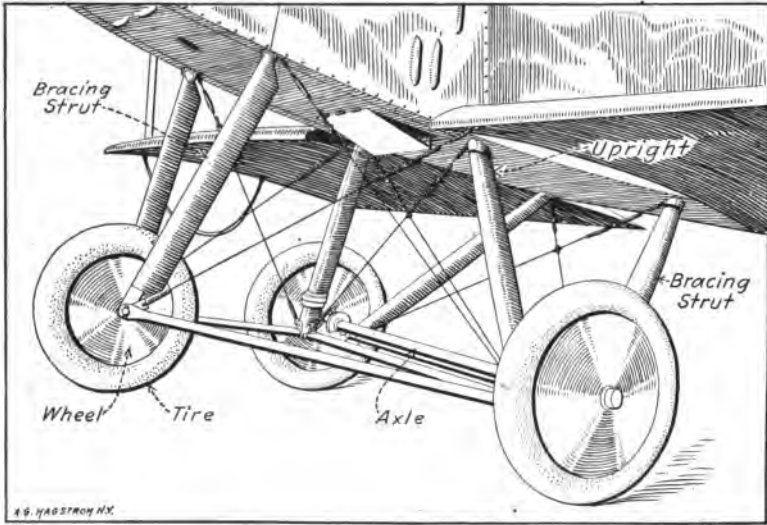


Fig. 59. Landing Gear Parts for Heavy Machine.



gear may be damaged under landing conditions that would not materially affect a two wheel landing gear.

Airplanes designed to rise from and alight on the water have supporting gears adapted for that medium. The simplest form is the pontoon type which is shown at Fig. 62 *A*. The form shown at *B* employs a main float of the single step hydroplane form. The type outlined at Fig. 62 *C* is known as a



**Fig. 60. Airplane Landing Gear of Three Wheel Type Showing Main Components.**

flying boat because the supporting wings and control surfaces are attached to what may be considered a regular boat hull.

**Woods for Airplane Parts.**—Woods used in aeronautical construction work may be divided into two classes, hard woods and soft woods, although in reality many excellent woods are of medium hardness. For the same bulk hard wood is far stronger than most soft woods, besides being more springy and flexible as a rule. For a given weight, however, some of the soft woods are far stronger than the hard woods, while a notable exception to the elastic superiority of hard woods is spruce, which is one of the most flexible and elastic of American woods and that most generally used in modern

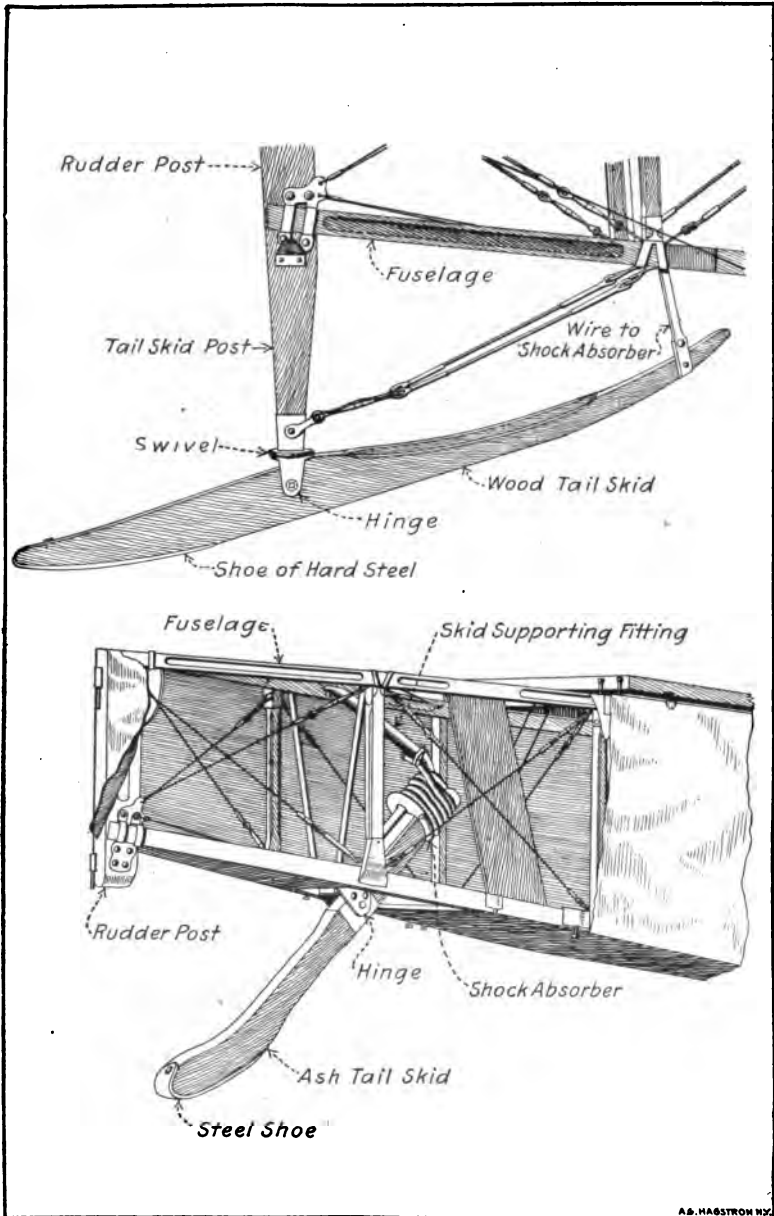


Fig. 61. Drawings of Typical Airplane Tail Skids, an Important Part of the Landing Gear.

A. B. HAGSTROM N.Y.

aircraft. Among the desirable American hardwoods may be mentioned:

*Apple*: A fine timber and with great resistance to splitting.

Difficult to secure in large, clear pieces. Excellent for propellers.

*Ash*: Good *white ash* is almost equal to hickory for strength and is exceedingly elastic but not very stiff. Apt to split

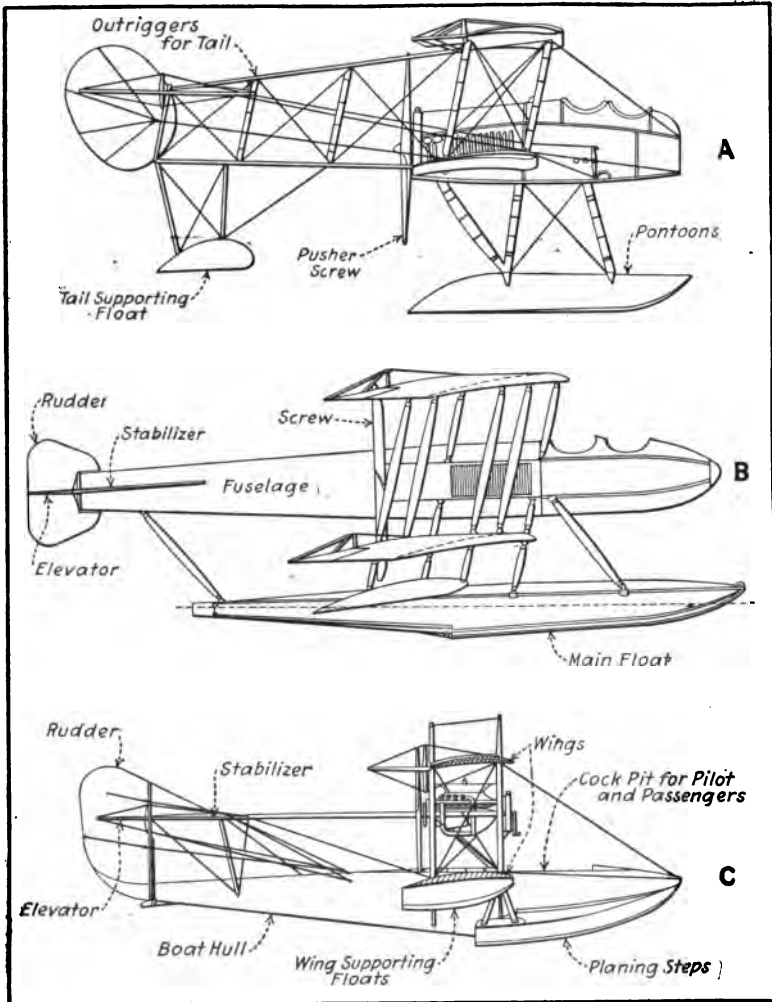


Fig. 62. The Three Types of Supporting Airplane Floats for Use in the Water.

up if of uneven grain and does not withstand exposure to weather without becoming rough.

*Black Ash:* Splits easily, is flexible and tough. Used extensively for barrel-hoops, oars and paddles.

*Beech:* A close-grained, hard, heavy wood; very stiff and rather brittle, but difficult to split.

*Birch:* Red, white and black birch are all handsome, durable woods of hard, close grain. Very difficult to split and very strong. Rather heavy and cross-grained but excellent for small parts where weight does not count for much.

*Buttonball:* (See *Sycamore*).

*Cherry:* Fine-grained, strong and free from faults, but not very elastic. Excellent for propeller construction.

*Chestnut:* Coarse-grained, rather soft and splits easily. Strong and durable, but will not withstand exposure to water as well as oak.

*Dogwood:* A hard, clear, close-grained tough wood; excellent for propellers.

*Elm:* Very tough, fibrous, free from splitting and difficult to work. Warps and twists badly under strain unless well braced or boxed in a covering of some other wood. One of the lightest of hard woods.

*Gum:* Nearly a soft wood, but so tough, fibrous and hard to split that it may be included among the hard woods. Used extensively for wooden plates, tubs, butter-dishes, firkins and drums. Should be excellent for hydroairplane floats or wherever toughness and flexibility are desired.

*Hickory:* One of the strongest and toughest of hard woods, particularly second-growth timber and "white" hickory. Easily steamed and bent; takes a splendid finish and is excellent for skids, runners, wheels, propellers, etc. Decays rapidly when exposed to weather.

*Hornbeam* or *Ironwood:* A very hard, fine-grained durable wood, difficult to obtain in large pieces. One of the strongest and hardest of American woods.

*Maple:* Lighter than most hard woods, does not split readily except close to the end and is flexible but brittle. Stands exposure well and will take a knife edge.

**Oak:** A valuable, hard, durable, tough, strong timber, but too heavy for most airplane purposes.

**Pear:** Similar to apple but more flexible. Use mainly for T-squares, etc.

**Sassafras:** Very strong, fine-grained, hard and takes a beautiful finish. Durable when exposed; will take a fine edge and should be a very useful material for propeller blades.

**Tupelo (Peppridge):** A very durable, close-grained, tough wood, free from splitting and far less known or used than it deserves.

**Walnut:** Rather brittle, but strong and light and mainly used in propeller construction.

Among the more noteworthy American soft woods are:

**Pine (White):** Very light and strong, but not very flexible and less desirable than spruce. *Yellow pine* is heavy, strong, but usually very pitchy. *California* and *Oregon pines* are flexible, tough, light and very similar to spruce.

**Basswood or Bastwood:** A very light, soft, strong, flexible and tough wood of fibrous grain. Used a great deal in boats and canoes and an excellent wood where lightness and ability to bend in any shape with freedom from splitting or breaking is desirable.

**Cedar:** *White cedar* is preëminently a superior boat timber and should prove a valuable wood for airplanes as it is light, strong, flexible and free from splitting. *Red cedar* is a strong, very durable wood, but usually very cross-grained and full of knots. *Arbor-Vitæ* is a variety of cedar very light and springy, fairly free from splitting and straight-grained. Much used for shingles.

**Cypress:** Used extensively in boat-building, owing to its durability, strength and freedom from warping, shrinking and swelling. A rather heavy wood and easily split.

**Poplar:** Very light, porous, soft wood of considerable toughness and strength, but decays rapidly. *Basswood* is sometimes known as "poplar" as is also *Whitewood*. Some varieties weigh as little as 20 pounds to the cubic foot, which is but 5 pounds heavier than cork.

*Redwood* (California): A beautiful, soft, easily worked wood similar in its properties to *Cypress*, but lighter.

*Spruce*: The various spruces, especially *Silver* and *California spruce*, are, as far as known, the most satisfactory woods for aeronautical use as they are exceedingly strong for their weight, are very flexible and tough and are probably among the most elastic woods known. Spruce splits easily, and the ends where exposed should be tipped with ferrules or wrapped with wire or shellacked thread as splits once started spread rapidly.

*Sycamore*: A very strong, durable, close-grained wood. Light in weight and exceedingly hard to split. Excellent for short struts, propeller blades, control parts, etc.

*Whitewood*: Also called "*Tulip Wood*," is a very fine-grained, soft, durable wood easily worked but brittle and not very strong.

*Willow*: Exceedingly strong for its weight and very flexible, especially when steamed or water-soaked. It should prove an excellent material for fuselage construction and for propellers.

**Metals Used in Airplanes.**—Although far less stronger than woods than is generally supposed, yet the various metals greatly exceed most woods in tensile strength and ultimate elasticity. Steels, irons, brass, bronzes, aluminum, monel-metal, etc., are used considerably in aeronautical construction, especially in motors and fuselage fittings, and the following brief descriptions of their compositions and characteristics may be of interest and value.

*Steel*, especially alloy steel, such as Vanadium, Chrome, Tungsten and Nickel-steels are the strongest metals known, and steel has been produced that showed a tensile strength of over 600,000 pounds per square inch. This was, however, merely experimental steel made in small quantities in the Krupp works and no steel of such strength has ever been produced in commercial quantities.

*Gray cast-iron*, French iron, Semi-steel and Vanadium-iron are all used extensively for cylinders, pistons, piston rings

and other parts where a splendid wearing surface and resistance to heat are required without great strength.

*Aerial Metal* is an alloy of aluminum and lithium of great strength and very light weight, some examples being only one and one-half times as heavy as water.

*Alumen*: An alloy of 88% aluminum with 10% zinc and 2% copper. One of the strongest aluminum alloys and readily forged and milled, but much heavier than aluminum or many other similar alloys.

TABLE VIII  
STRENGTHS OF VARIOUS MATERIALS  
Woods

Name	Pounds per Cubic Foot	Tensile Strength in Pounds	Compressive Strength in Pounds
Alder.....	..	.....	6,000- 7,000
Apple.....	..	.....	.....
Ash.....	43	11,000	4,600- 8,000
Bamboo.....	20	.....	.....
Beech.....	43	8,000-12,000	8,000- 9,000
Birch.....	35	7,000-10,000	5,000-10,000
California spruce.....	..	12,000-14,000	.....
Cedar.....	35	4,000- 9,500	4,000- 6,500
Cherry.....	..	.....	5,000- 6,500
Chestnut.....	..	7,000-12,000	4,000- 4,800
Elm.....	36	8,000-13,000	8,000-10,000
Hickory.....	43	10,000-14,000	8,000- 9,000
Maple.....	40	8,000-10,000	5,000- 6,000
Oak (live).....	67	10,000	8,000-10,000
Oak (white).....	43	10,000	5,000- 8,000
Pear.....	..	7,000-10,000	7,500
Pine (Oregon).....	..	9,000-14,000	.....
Pine (Pitch).....	..	8,000-10,000	.....
Pine (red).....	..	5,000- 8,000	6,000- 7,500
Pine (white).....	29	3,000- 7,500	3,000- 6,000
Pine (yellow).....	34	5,000-12,000	6,500-10,000
Poplar.....	24	3,000- 7,000	5,000- 8,000
Spruce (New Eng.).....	31	5,000-10,000	4,500- 6,000
Spruce (Norway).....	32	5,000-12,500	.....
Spruce (California).....	..	12,000-14,000	.....
Sycamore.....	39	.....	.....
Walnut (black).....	..	8,000	5,600- 7,000
Willow.....	37	10,000	3,000- 6,000

TABLE IX  
STRENGTHS OF VARIOUS MATERIALS—Continued

## Metals

Name	Pounds per Cubic Foot	Tensile Strength	Compressive Strength
Aerial metal.....	98	60,000- 70,000	.....
Alumen.....	184	42,660	.....
Aluminum.....	168	38,393	.....
Aluminum bronze.....	481	92,430	.....
Brass.....	526	85,320- 86,742	.....
Chromaluminum.....	184	63,990	.....
Cast iron.....	444	20,000- 35,000	75,000-150,000
Copper.....	...	56,880- 58,302	.....
Iron (wrought).....	482	119,448	.....
Magnalium.....	152	41,238- 63,990	.....
Monelmetal.....	525	87,000-110,000	.....
Nickel-aluminum.....	184	56,880	.....
Steel (alloy).....	485	125,000-265,000	.....
Steel (piano wire).....	490	99,540-312,840	.....

Name	Miscellaneous Tensile Strength in Pounds
China Grass.....	22,752
Glue.....	500- 750
Hemp.....	6,285-17,000
Horn.....	9,000
Ivory.....	16,000
Leather.....	3,000- 5,000
Rawhide.....	12,000
Silk.....	35,000-62,028
Whalebone.....	7,600

*Argentium* is a patented German alloy of aluminum and silver. Its specific gravity is 2.9.

*Chromaluminum* is another patented German alloy of aluminum, chromium, etc. Its specific gravity is similar to the last and it is the strongest known aluminum alloy.

*Magnalium*: An alloy of aluminum and magnesium, the latter varying from 2% to 12%. Weighs less than pure aluminum and is very strong. It resists corrosion about the same as aluminum and may be easily cast, forged, machined, rolled and drawn.



*Wolframium* is an aluminum and tungsten alloy with small amounts of copper and zinc. It is patented in Germany and is extensively used in the Zeppelin dirigibles.

*Bronzes* are all those alloys in which copper is combined with other metals to gain strength or other advantages.

*Phosphor-bronze* is particularly adapted for wire and cable.

*Manganese bronze* is nearly as strong as ordinary steel.

*Tobin bronze* has a strength equal to steel and is used largely for marine propeller shafts, while *Aluminum bronze* is very tough and elastic, but like all the bronzes is too heavy to be of great value in aviation work.

*Monelmetal*, a natural alloy of nickel, iron and copper, is as strong as high-grade steel, resists all known causes of corrosion save sulphur fumes and is readily worked, but is very heavy for aerial work. It is, however, the ideal metal for boat and hydroairplane uses.

TABLE X

## TRANSVERSE STRENGTHS OF WOODEN BARS

(Those marked \* were supported edgewise; all tests were with bars supported at extreme ends)

Name	Size in Inches	Weight, Ounces	Load Sustained, Pounds
Elm.....	1 ½ × 1 ½ × 12	5¼	900
Spruce.....	1 ½ × 1 ½ × 12	4¼	900
Elm.....	1 ½ × 1 ½ × 12	4¾	880
Spruce.....	1 ½ × 1 ½ × 12	3¾	760
Elm.....	1 × 1 × 12	4	450
Spruce.....	1 × 1 × 12	3½	600
*Elm.....	¾ × 1 ½ × 12	3½	390
*Spruce.....	¾ × 1 ½ × 12	3	475
Elm.....	¾ × ¾ × 12	2½	275
Spruce.....	¾ × ¾ × 12	2¼	280
*Elm.....	¾ × ¾ × 12	2½	175
*Spruce.....	¾ × ¾ × 12	2	175

## MASS OF MATERIAL TO CONSTRUCT AN AIRPLANE

There is a surprising amount of material of various kinds necessary to build a single airplane of the more simple kind.

Materials involving metals of various kinds include the following:

Nails.....	4,326
Screws.....	3,377
Steel Stampings.....	921
Forgings.....	798
Turnbuckles.....	276
Wire.....	3,262 feet
Aluminum.....	65 pounds

The various kinds of wooden material mount up as follows:

Spruce.....	244 feet
Pine.....	58 feet
Ash.....	31 feet
Hickory.....	1½ feet

Other material necessary for the finished plane is as follows:

Veneer.....	57 square feet
Varnish.....	11 gallons
Dope.....	59 gallons
Rubber.....	34 feet
Linen.....	201 square yds.

This list of material is exclusive of everything necessary for the engine alone.

## CHAPTER VII

### AIRPLANE POWER-PLANTS

**Aerial Motors Must be Light—Factor Influencing Power Needed—Airplane Engine Forms—Airplane Engine Installation—Standard S. A. E. Engine Bed Dimensions—Installing Rotary and Radial Cylinder Engines—Characteristics of Typical American Pre-War Aviation Engines.**

ONE of the marked features of aircraft development has been the effect it has had upon the refinement and perfection of the internal combustion motor. Without question, gasoline motors intended for aircraft are the nearest to perfection of any other type yet evolved. Because of the peculiar demands imposed upon the aviation motor, it must possess all the features of reliability, economy and efficiency now present in automobile or marine engines. It must also have distinctive points of its own. Owing to the unstable nature of the medium through which it is operated and the fact that heavier-than-air machines can maintain flight only as long as the power-plant is functioning properly, an airship motor must be more reliable than any used on either land or water. While a few pounds of metal, more or less, make practically no difference in a marine motor and have very little effect upon the speed or hill-climbing ability of an automobile, an airship motor must be as light as it is possible to make it because every pound counts, whether the motor is to be fitted into an airplane or into a dirigible balloon.

Airship motors, as a rule, must operate constantly at high speeds in order to obtain a maximum power delivery with a minimum piston displacement. In automobiles or motor-boats, motors are not required to run constantly at their maximum speed. Most aircraft motors must function for extended periods at speeds as nearly the maximum as possible. Another thing that militates against the aircraft motor is the more or less unsteady foundation to which it is attached.

The necessarily light framework of the airplane makes it hard for a motor to perform at maximum efficiency on account of the vibration of its foundation while the craft is in flight. Marine and motor car engines, while not placed on foundations as firm as those provided for stationary power-plants, are installed on bases much more stable than the light structure of an airplane. The aircraft motor, therefore, must be balanced to a nicety and must run steadily under the most unfavorable conditions.

#### AERIAL MOTORS MUST BE LIGHT

The capacity of light motors designed for aerial work per unit of mass is surprising to those not fully conversant with the possibilities that a thorough knowledge of proportions of parts and the use of special metals developed by the automobile industry make possible. Activity in the development of light motors has been more pronounced in France than in any other country. Some of these motors have been very complicated, made light by the skilful proportioning of parts, others are of the refined simpler form, modified from present-day automobile practice. There is a tendency to depart from the freakish or unconventional construction and to adhere more closely to standard forms because it is necessary to have the parts of such size that every quality making for reliability, efficiency and endurance is incorporated in the design. Airplane motors range from two cylinders to forms having fourteen, sixteen, eighteen and twenty-four cylinders, and the arrangement of these members varies from the conventional vertical tandem and opposed placing to the V form or the more unusual radial or star motors having either fixed or rotary cylinders. The weight has been reduced so it is possible to obtain a complete power-plant of the revolving cylinder air-cooled type that will not weigh more than 3 pounds per actual horse-power and in some cases less than this figure.

If we give brief consideration to the requirements of the aviator it will be evident that one of the most important is securing maximum power with minimum mass, and it is desirable to conserve all of the good qualities existing in standard

automobile motors. These are certainty of operation, good mechanical balance and uniform delivery of power—fundamental conditions which must be attained before a power-plant can be considered practical. There are in addition secondary considerations, none the less desirable, if not absolutely essential. These are minimum consumption of fuel and lubricating oil, which is really a factor of import, for upon the economy depends the capacity and flying radius. As the amount of liquid fuel must be limited, the most suitable motor will be that which is most powerful and at the same time economical.

Another important feature is to secure accessibility of components in order to make easy repair or adjustment of parts possible. It is possible to obtain sufficiently light-weight motors without radical departure from established practice. Water-cooled power-plants have been designed that will weigh but 3.5 to 4 pounds per horse-power complete, and in these forms we have a practical power-plant capable of extended operation.

#### FACTOR INFLUENCING POWER NEEDED

Work is performed whenever an object is moved against a resistance, and the amount of work performed depends not only on the amount of resistance overcome, but also upon the amount of time utilized in accomplishing a given task. Work is measured in horse-power for convenience. It will take one horse-power to move 33,000 pounds 1 ft. in one minute or 550 pounds 1 ft. in one second. The same work would be done if 330 pounds were moved 100 ft. in one minute. It requires a definite amount of power to move a vehicle over the ground at a certain speed, so it must take power to overcome resistance of an airplane in the air. Disregarding the factor of air density, it will take more power as the speed increases if the weight or resistance remains constant, or more power if the speed remains constant and the resistance increases.

The airplane is supported by air reaction under the planes or lifting surfaces and the value of this reaction depends upon

the shape of the aerofoil, the amount it is tilted and the speed at which it is drawn through the air. The angle of incidence or degree of wing tilt regulates the power required to a certain degree as this affects the speed of horizontal flight as well as the resistance. Resistance may be of two kinds, one that is necessary and the other that it is desirable to reduce to the lowest point possible. There is the wing resistance and the sum of resistances of the rest of the machine such as fuselage, struts, wires, landing gear, etc. If we assume that a certain airplane offered a total resistance of 300 pounds and we wished to drive it through the air at a speed of 60 miles per hour, we can find the horse-power needed by a very simple computation as follows:

$$\begin{array}{r} \text{The product of: } 300 \text{ pounds resistance} \\ \text{times speed of } 88 \text{ ft. per second times } 60 \\ \text{seconds in a minute} \\ \hline \text{divided by } 33,000 \text{ foot-pounds per minute} \\ \text{in one horse-power} \end{array} = \text{H.P. needed}$$

$$\begin{array}{r} \text{The result is the horse-power needed, or} \\ 300 \times 88 \times 60 \\ \hline 33,000 \end{array} = 48 \text{ H.P.}$$

Just as it takes more power to climb a hill than it does to run a car on the level, it takes more power to climb in the air with an airplane than it does to fly on the level. The more rapid the climb, the more power it will take. Naturally the resistance is greater when climbing. If the resistance remains 300 pounds and it is necessary to drive the plane at 90 miles per hour, we merely substitute proper values in the above formula and we have

$$\begin{array}{r} 300 \text{ pounds times } 132 \text{ ft. per second times} \\ 60 \text{ seconds in a minute} \\ \hline 33,000 \text{ foot-pounds per minute in one} \\ \text{horse-power} \end{array} = 72 \text{ H.P.}$$

The same results can be obtained by dividing the product of the resistance in pounds times speed in feet per second by 550, which is the foot-pounds of work done, in one second to

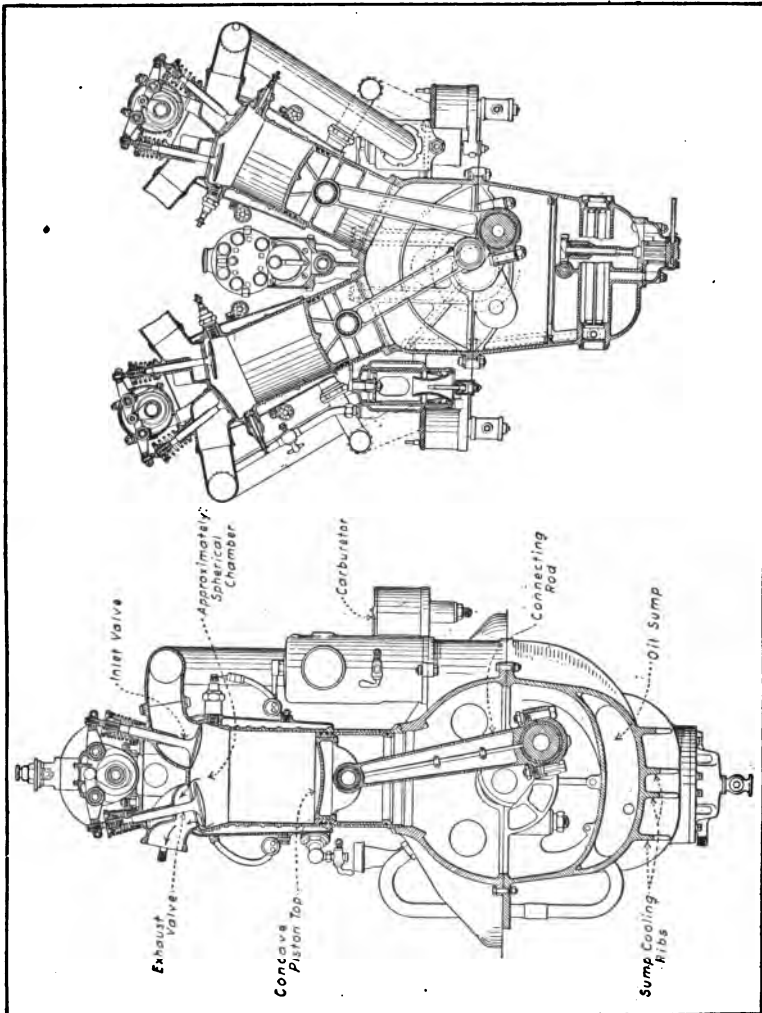


Fig. 63. Typical Aircraft Engines. At Left, Six-Cylinder Vertical Form; at Right, "V" Type with Twelve Cylinders.

equal one horse-power. Naturally, the amount of propeller thrust measured in pounds necessary to drive an airplane must be greater than the resistance by a substantial margin if the plane is to fly and climb as well.

## AIRPLANE ENGINE FORMS

Inasmuch as numerous forms of airplane engines have been devised, it would require a volume of considerable size to describe even the most important developments of recent years. As considerable explanatory matter has been given in

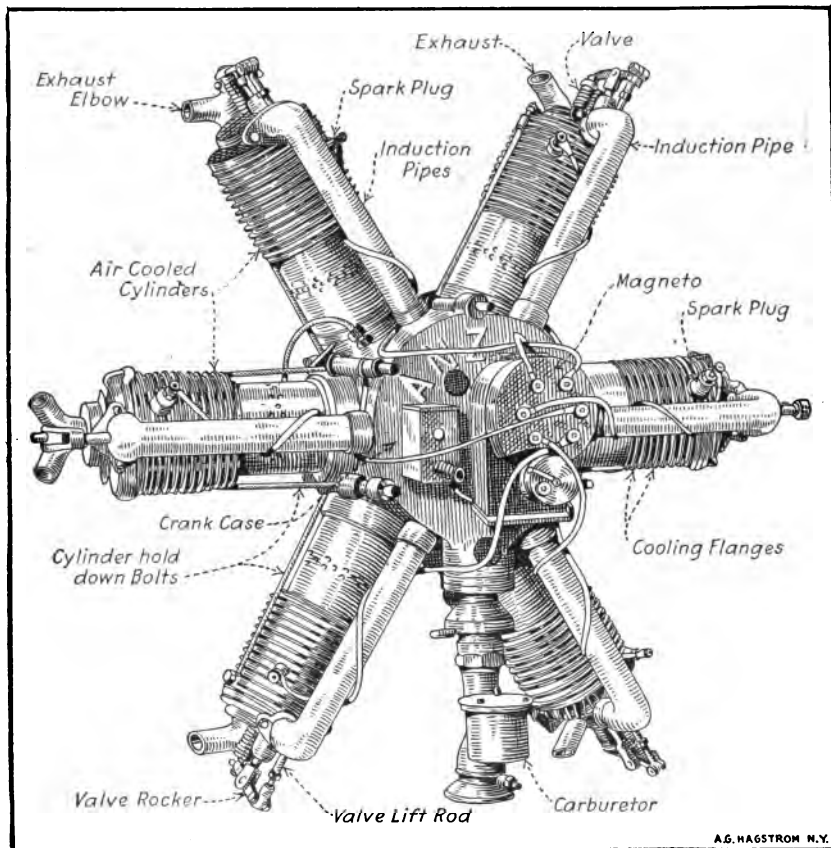


Fig. 64. The Anzani Six-Cylinder Fixed Radial Engine.

preceding chapters and the principles involved in internal combustion engine operation considered in detail, a relatively brief review of the features of some of the most successful airplane motors should suffice to give the reader a complete enough understanding of the art so all types of engines can



be readily recognized and the advantages and disadvantages of each type understood.

Aviation engines can be divided into three main classes. One of the earliest attempts to devise distinctive power-plant designs for aircraft involved the construction of engines utilizing

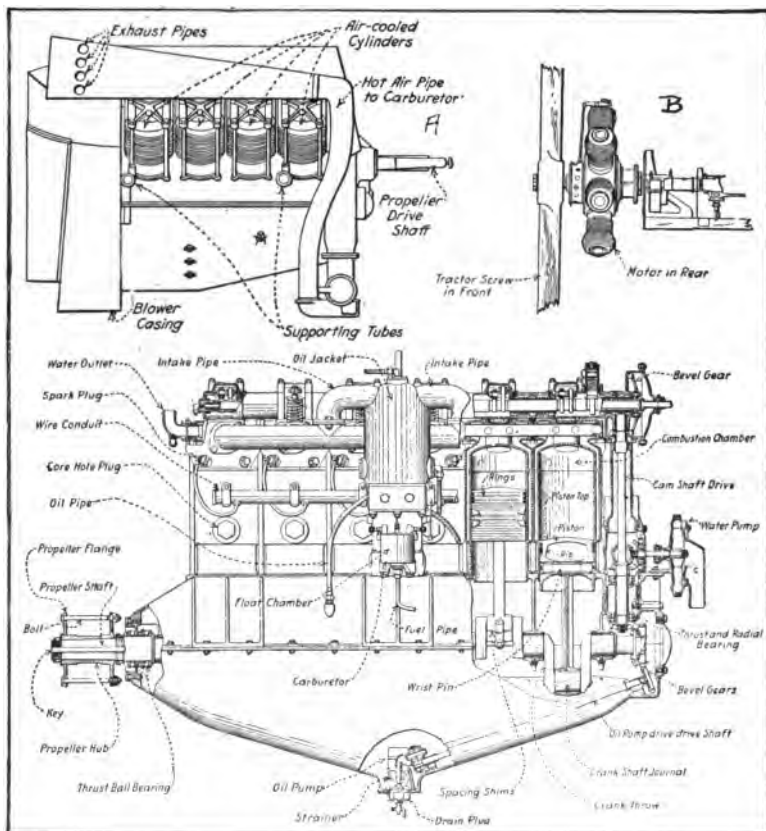


Fig. 65. Air- and Water-Cooled Aviation Power-Plants. A. Renault Eight-Cylinder. B. Gnome Rotary. Below Six-Cylinder Type.

a radial arrangement of the cylinders or a star-wise disposition. Among the engines of this class may be mentioned the Anzani, in its various forms. These are air-cooled. Engines of this type have been built in cylinder numbers ranging from three to twenty. While the simple forms were popular in the early

days of aviation engine development, they have been succeeded by the more conventional arrangements which now form the largest class. The reason for the adoption of a star-wise arrangement of cylinders, shown at Fig. 64, has been previously considered. Smoothness of running can only be obtained by using a considerable number of cylinders. The fundamental reason for the adoption of the star-wise disposition is that a better distribution of stress is obtained by having all of the pistons acting on the same crank-pin so that the crank-throw and pin are continuously under maximum stress. Some difficulty has been experienced in lubricating the lower cylinders in some forms of six-cylinder, rotary crank, radial engines, but these have been largely overcome so they are not as serious in practice as a theoretical consideration would indicate.

Another class of engines developed to meet aviation requirements is a complete departure from the preceding class, though when the engines are at rest it is difficult to differentiate between them. This class includes engines having a star-wise disposition of the cylinders but the cylinders themselves and the crank-case rotate and the crank-shaft remains stationary. The important rotary engines are the Gnome, the Le Rhone and the Clerget. By far the most important classification is that including engines which retain the approved design of the types of power-plants that have been so widely utilized in automobiles and which have but slight modifications to increase reliability and mechanical strength and produce a reduction in weight as outlined in Fig. 63 and in Fig. 65. This class includes the vertical engines such as the Hall-Scott four-cylinder; the Mercedes, Benz, and Hall-Scott six-cylinder vertical engines and the numerous eight- and twelve-cylinder "V" designs such as the Curtiss and Renault.

#### AIRPLANE ENGINE INSTALLATION

The proper installation of the airplane power-plant is more important than is generally supposed, as while these engines are usually well balanced and run with little vibration, it is necessary that they be securely anchored and that various connections to the auxiliary parts be carefully made in order

to prevent breakage from vibration and that attendant risk of motor stoppage while in the air. The type of motor to be

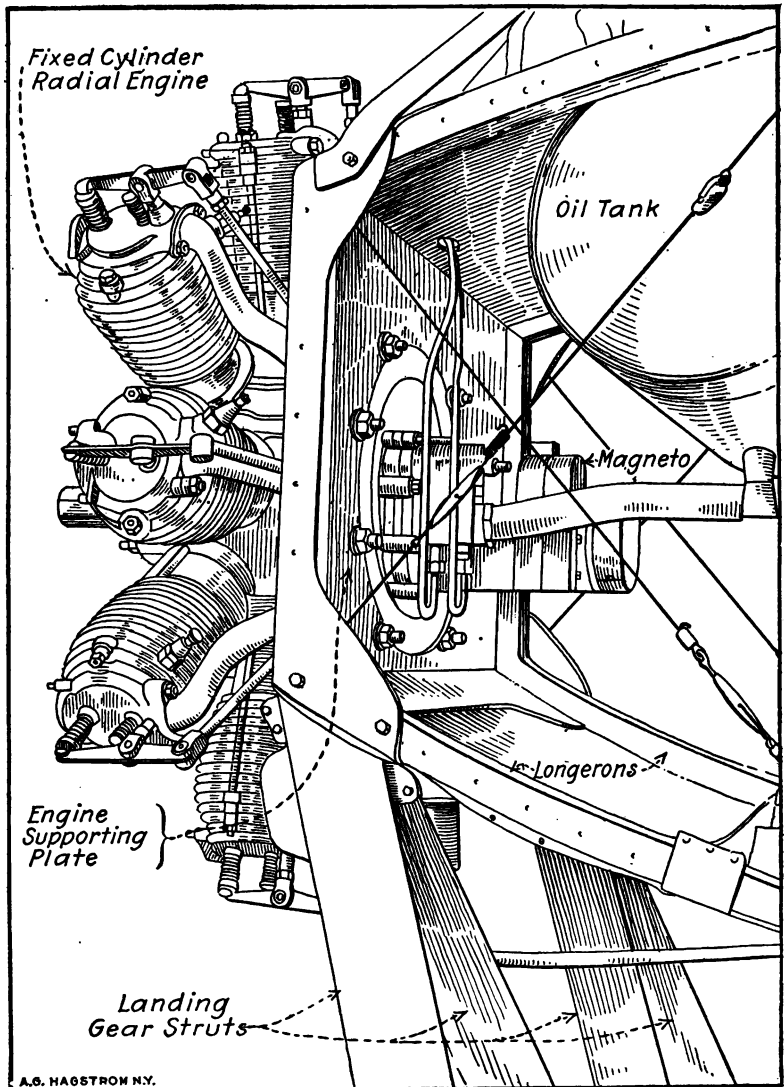
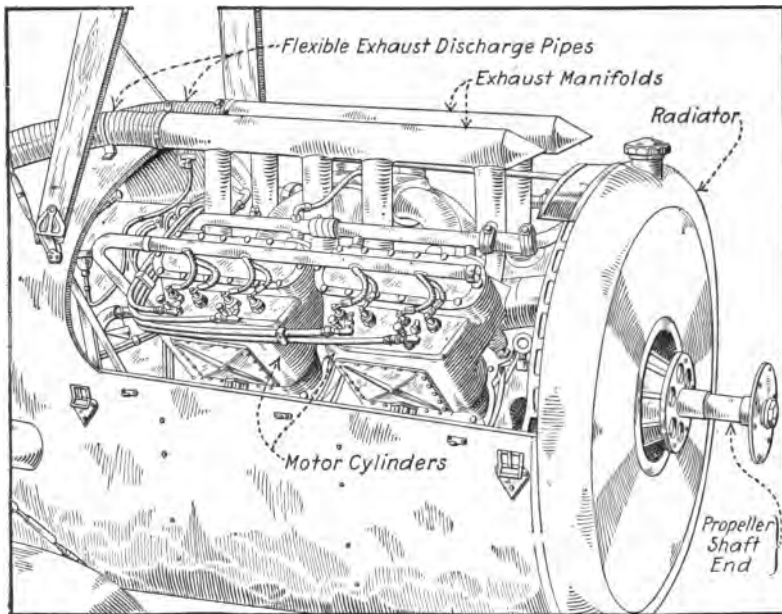


Fig. 66. Anzani Ten-Cylinder Engine Installed in Fuselage.

installed determines the method of installation to be followed. As a general rule the six-cylinder vertical engine and eight-

cylinder "V" type are mounted in substantially the same way. The radial, fixed cylinder forms and the radial, rotary cylinder Gnome and Le Rhoné rotary types require an entirely different method of mounting. The usual form of engine bed for a fixed cylinder engine is shown at Fig. 68.

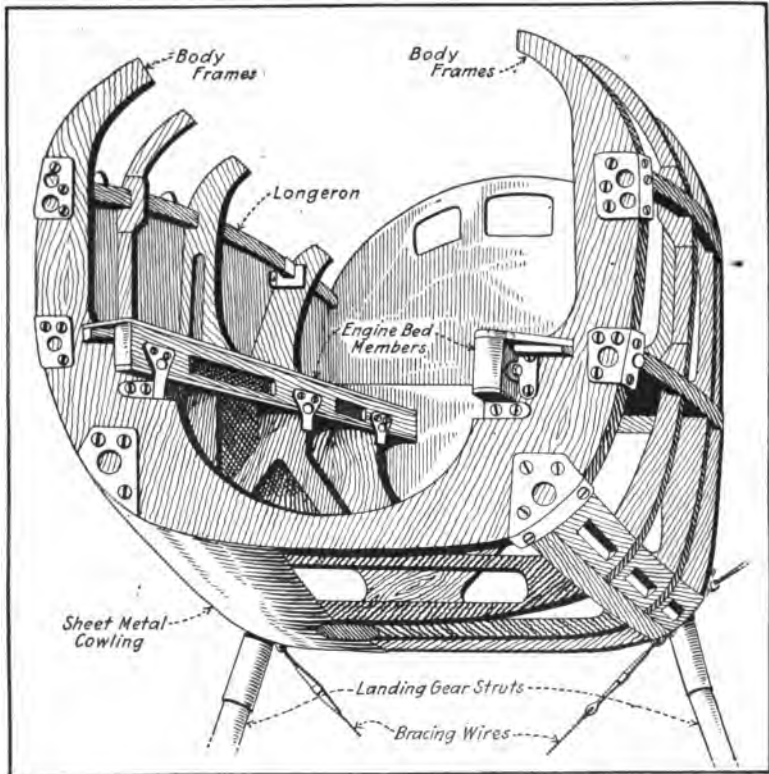
In a number of airplanes of the tractor-biplane type the power-plant installation is not very much different than that which is found in automobile practice. The illustration at top



**Fig. 67. Showing Engine Installation in Monocoque Fuselage.**

of Fig. 70 is a very clear representation of the method of mounting the Curtiss eight-cylinder 90 H.P. engine in the fuselage of the Curtiss tractor-biplane which is so generally used as a training machine. It will be observed that the fuel tank is mounted under a cowl directly behind the motor and that it feeds the carburetor by means of a flexible fuel pipe. As the tank is mounted higher than the carburetor, it will feed that member by gravity. The radiator is mounted at the front end of the fuselage and connected to the water piping on the

motor by the usual rubber hose connections. An oil pan is placed under the engine and the top is covered with a hood just as in motor car practice. Panels of aluminum (not shown in cut) are attached to the sides of the fuselage and are supplied with doors which open and provide access to the carburetor, oil-gauge and other parts of the motor requiring



**Fig. 68. Engine Bed Construction in Typical German Airplane.**

inspection. A complete installation with the power-plant enclosed is given at Fig. 67, and in this it will be observed that the exhaust pipes are connected to discharge members that lead the gases away toward the rear of fuselage. In the engine shown at top of Fig. 70 the exhaust flows directly into the air at the sides of the machine through short pipes bolted to the exhaust gas outlet ports. The installation of the

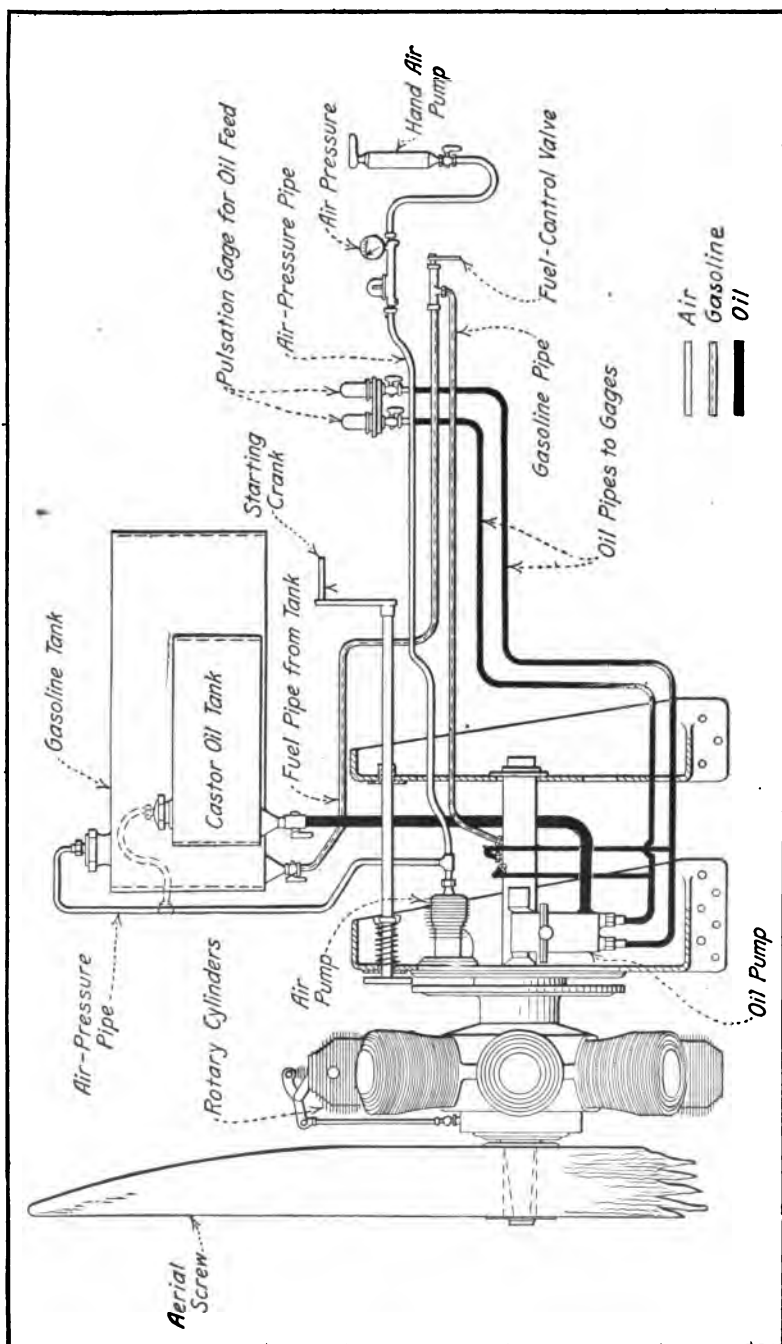


Fig. 69. How Rotary Motor is Installed, Showing Air, Fuel and Oil Lines.

radiator just back of the tractor screw insures that adequate cooling will be obtained because of the rapid air flow due to the propeller slip stream. The engine installed in the airplane shown in Fig. 70 B is a four-cylinder type and the radiator is mounted above the motor instead of in front, as depicted in Fig. 70 A.

#### STANDARD S. A. E. ENGINE BED DIMENSIONS

The Society of Automotive Engineers have made efforts to standardize dimensions of bed timbers for supporting power-plant in an airplane. Owing to the great difference in length no standardization is thought possible in this regard. The dimensions recommended are as follows:

Distance between timbers.....	12 in.	14 in.	16 in.
Width of bed timbers.....	1½ in.	1¾ in.	2 in.
Distance between centers of bolts.....	13½ in.	15¾ in.	18 in.

It will be evident that if any standard of this nature were adopted by engine builders that the designers of fuselage could easily arrange their bed timbers to conform to these dimensions, whereas it would be difficult to have them adhere

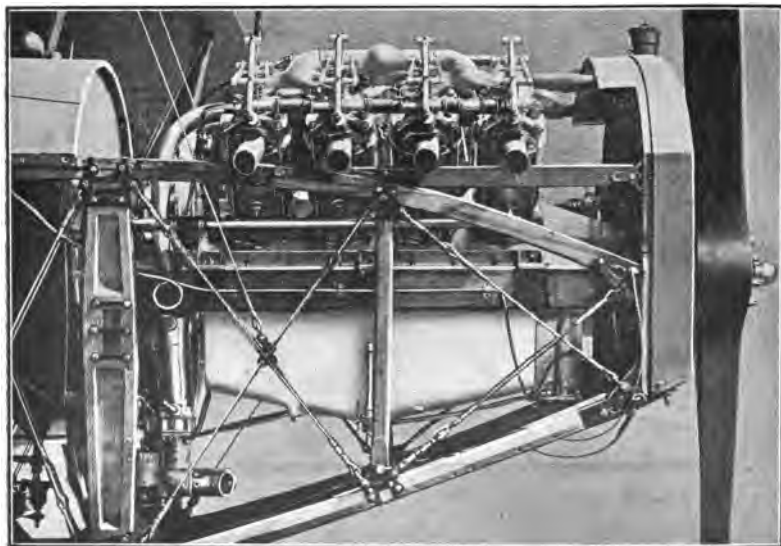
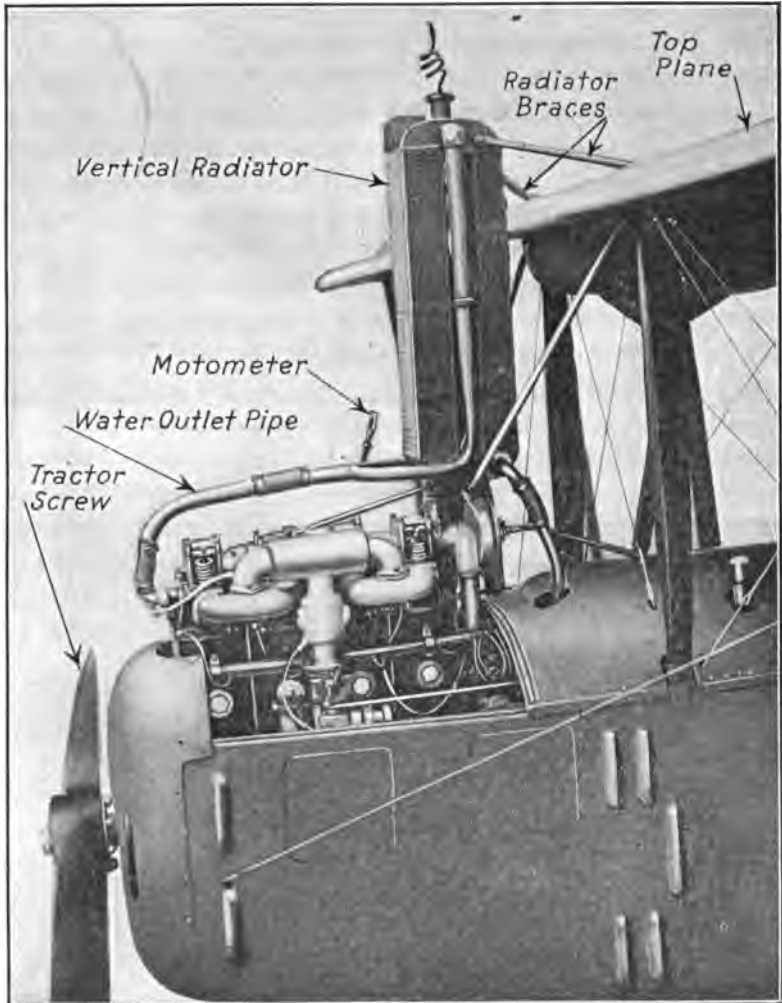


Fig. 70 A. How Airplane Engines are Installed in Fuselage.

to any standard longitudinal dimensions which are much more easily varied in fuselages than the transverse dimensions are. It, however, should be possible to standardize the longitudinal



**Fig. 70 B. How Airplane Engines Are Installed in Fuselage.**

positions of the holding down bolts as the engine designer would still be able to allow himself considerable space fore-and-aft of the bolts.



## CHARACTERISTICS OF TYPICAL AMERICAN PRE-WAR AVIATION ENGINES

Maker's Name and Model	Number of Cyl.	Bore (Inches)	Stroke (Inches)	Piston Displacement (Cubic Inches)	H. P.	R. P. M.	Weight of Engine with Carburetor and Ignition	Gas Consumption
Curtiss OX.....	8	4	5	502.6	90	1400	375	10 gals. per hour
Curtiss OXX-2.....	8	4¼	5	567.5	100	1400	423	11 gals. per hour
Curtiss V-2.....	8	5	7	1100	200	1400	690	.....
Duesenberg A-4.....	4	4¾	7	496	140	2100	455	.....
General Vehicle Gnome Mono (Rotary Air Cooled)	9	4.33	5.9	848	100	1200	272	12 gals. per hour at rated H.P.
Hall-Scott A-7.....	4	5	7	550	90-100	1400	410	.....
Hall-Scott A-5.....	6	5	7	825	125	1300	592	.....
Hispano Suiza.....	8	4½	5	672	154	1500	455	.....
Sturtevant 5-A.....	8	4	5½	.....	140	2000	514	13.75 gals. per hour
Thomas 8.....	8	4	5½	552.9	135	2000	630 with self-starter	59 lbs. per B. H. P. hr.
Thomas 88.....	8	4½	5½	552.9	150	2100	525 lbs. with self-starter	59 lbs. per B. H. P./hr.
Wisconsin.....	6	5	6½	765.7	140	1380	637	.....

(NOTE.—Engines running at speeds in excess of 1500 R.P.M. have a reduction gear for driving propeller. The great improvements made in aviation engine design since the start of our war preparations cannot be described on account of censorship regulations.)

INSTALLING ROTARY AND RADIAL CYLINDER ENGINES

When rotary engines are installed simple steel stamping or "spiders" are attached to the fuselage to hold the fixed crank-shaft. Inasmuch as the motor projects clear of the fuselage proper there is plenty of room back of the front spider plate to install the auxiliary parts, such as the oil pump, air pump and ignition magneto and also the fuel and oil containers. The diagram given at Fig. 69 shows how a Gnome "monosoupape" engine is installed on the anchorage plates; and it also outlines clearly the piping necessary to convey the oil and fuel and also the air piping needed to put pressure on both fuel and oil tanks to insure positive supply of these liquids, which may be carried in tanks placed lower than the motor in some installations. The simple mounting possible when the Anzani ten-cylinder radial fixed type engine is used is given at Fig. 66. The front end of the fuselage is provided with a substantial pressed steel plate having members projecting from it which may be bolted to the longerons. The bolts that hold the two halves of the crank-case together project through the steel plate and hold the engine securely to the front end of the fuselage.

NOTE.—For a more complete discussion of airplane power plants the reader is referred to "Aviation Engines" by Pagé, price \$3.00, which can be obtained from The Norman W. Henley Pub. Co., 2 West 45th Street, New York City.

## CHAPTER VIII

### AIRPLANE PROPELLER CONSTRUCTION AND ACTION

When Screw Works in Air—Mathematical Consideration of Propeller Pitch—Propeller Definitions—Propeller Manufacturing Practice—Theories of Screw Propeller Action—How Propellers are Balanced—The Disc Theory—The Blade Theory.

THE principle of the screw was applied by Archimedes, the Grecian mathematician, in raising water as early as 200 B. C., and the screw or helical rotating propeller has been associated with methods for the propulsion of aerial craft for four or five centuries. The original screw propeller was of the single worm type, having but one thread, and could hardly be compared with the present form. That we may properly appreciate the functions of the screw propeller we have an excellent demonstration of the principles involved in the bolt and nut, with which all are familiar.

A screw is a cylinder having a spiral ridge or thread around it, which cuts at a constant oblique angle all the lines of a

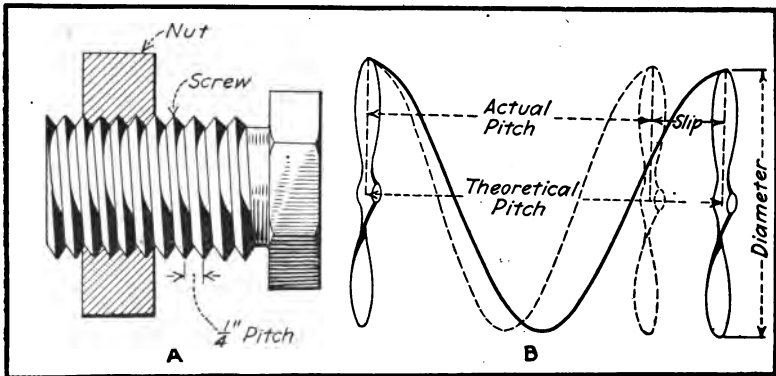


Fig. 71. Diagrams Explaining Pitch of Aerial Screw Propeller.

surface parallel to the axis of the cylinder. A hollow cylinder, called a nut, having a similar spiral within it is fitted to move

freely upon the thread of the solid cylinder as shown at Fig. 71 A. For simplicity we will consider that there are four threads to the inch. Obviously, if the nut was held stationary, in four complete turns the screw would advance or recede an inch if the screw were turned toward the right or left. On the other hand, we will assume that the nut is so held that it can travel only back and forth and not around when the screw is turned. Four complete turns of the screw would produce a movement of one inch, one complete turn would move the nut one-quarter inch. This distance is the pitch of the screw, as the definition is: The pitch of a screw is the distance through which the screw would advance in one revolution, provided that it revolved in an unyielding medium, such as a solid nut.

It will be evident that if the thread of the bolt were of such depth to offer sufficient area that considerable resistance would be offered to its backing in or coming out of a more flexible medium in which the bolt was submerged, such as water, that the water surrounding the threads would act to a certain extent as a nut, and assuming that this did not move either backward or forward, as would be the case were the nut of resisting material held immovable, it may be seen that revolving the bolt would tend to exert a thrust which would produce either forward or reverse movement of the bolt. This is the principle of the screw propeller whether it operates in air or a denser medium, such as water. The less the density of the fluid in which the propeller is submerged, the greater the area of blade or thread surface necessary to exert the same thrust.

If the screw is mounted in such a way that it is continuously revolved, it will produce a continuous movement. For instance, assuming that the bolt has a pitch of one inch and that it worked in an elastic medium less resistant than solid substances of which nuts are usually made: As it is turned there would be two effects: the bolt would move forward, and the fluid in which it turned would be pushed backward. Thus the effect of screw propeller would be duplicated. Because turning the bolt pushed back the elastic substance in which it was submerged as well as producing forward movement of

the bolt, it would not advance as much per revolution as though it were working in an unyielding medium; for instance, while the pitch was one inch, and theoretically considered, the bolt should move forward a distance corresponding to the pitch, because of the reaction, the degree of movement which actually takes place would be considerably reduced.

For considerations of balance, an aerial propeller is not based on the design of a single thread screw but on a double, triple or quadruple thread type, depending on the number of blades.

#### WHEN SCREW WORKS IN AIR

In the case of a screw working in air, however, we are concerned with very different conditions from those found in a rigid combination such as we have just instanced. Air is a highly rarefied medium, the density being only one eight-hundredth that of water, and one six-thousandth that of steel. A *perfect liquid* is one whose *molecules* are perfectly free to move over one another with the slightest disturbing force—and air approaches very near to such an ideal liquid. With a screw working in such an elastic and accommodating medium it will not be surprising to find a certain amount of air slip beneath the blades so that the space covered per revolution is always something less than that represented by the geometric proportions of the screw blade. (See Fig. 71 B.) The axial space covered by a propeller for the incoming air is given an added velocity in passing through the propeller disc. At zero slip no additional velocity and no rearward momentum is imparted to the incoming air stream, and as a consequence the thrust will be zero and there will be no true wake stream beyond that due to skin friction. The advance per revolution at which no thrust is obtained is termed the *mean experimental pitch* or *zero thrust pitch* of the propeller. It is a value found experimentally by artificially driving the screw through the air at increasing velocities till the point is reached at which there is no thrust. The experiment is usually done on a large whirling arm or in a wind tunnel, but an approximate value can be found quite easily by placing the estimated no-lift line

on the blade section at two-thirds full diameter, this being at, or near, the center of pressure of the blade. Its value will vary slightly along the blade, but a very good approximation to the

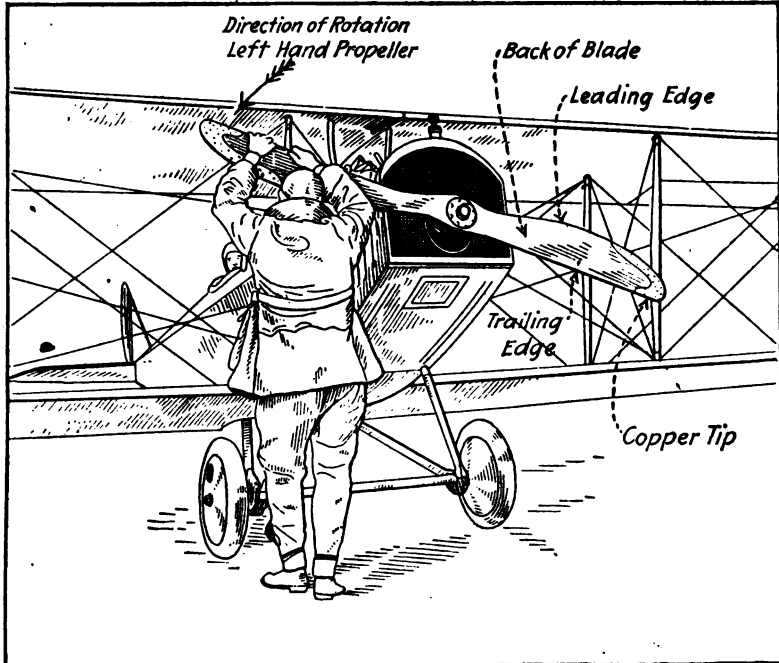


Fig. 72. How to Start Engine Fitted with Aerial Screw That Turns Left Hand, or Anti-clockwise, When Viewed from Front of Airplane. If considered from Viewpoint of Pilot, This is a Right-Hand Screw.

experimental value may be found by taking the section thus defined as a criterion.

#### MATHEMATICAL CONSIDERATION OF PROPELLER PITCH

The geometrical blade pitch face is the aerial span of one twist of a helical line of constant angularity and radius: each revolution is termed its *mean effective pitch*. It is a function of the thrust of any instant and varies with each manoeuvre of the pilot. Thus, under climbing conditions, the effective pitch may drop 50 per cent. of its value in level flight, the slip, of course, increasing at the same rate. An analogous case may be found in the slip of an ordinary bolt and nut, as often

happens in driving against a heavy load. In the case of the air screw, however, the thrust is obtained *by reason of* the slip of air under the blades, so, equal to that at the section taken. The fact that only a small fraction of a complete twist actually exists in the aerial propeller does not affect the argument as the pitch is quite independent of the blade width, but is a function only of the angle and radius of rotation. It usually varies along the blade and in most cases gets greater towards the boss, so that the blade face is not part of a true helix. It is necessary, then, to state precisely the section at which measurement is to be made. The general rule is to take the blade angle at two-thirds full propeller diameter as a basis

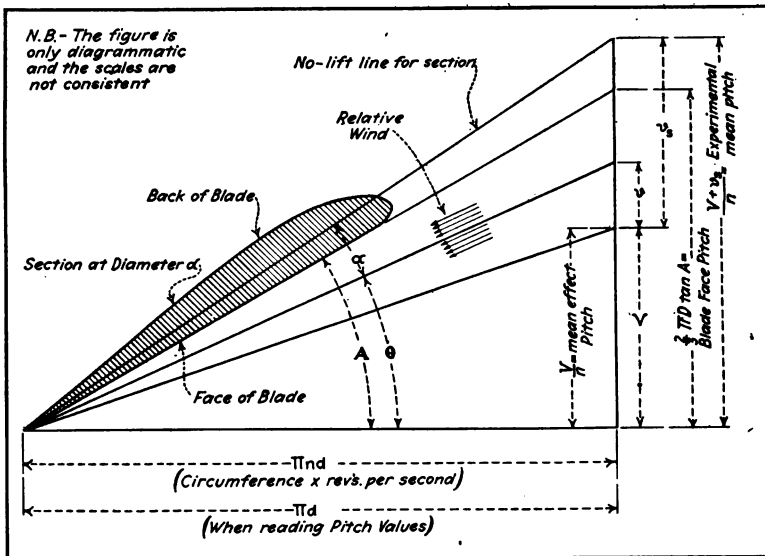


Fig. 73. Diagram Showing Some Points of Aerial Screw Design Considered Mathematically.

for calculation. The value so found is the *blade pitch*, or simply the pitch, as ordinarily referred to by propeller makers and dealers, and it is the figure stamped on the boss. It is very important to remember that this is a purely geometrical quantity, depending only on the angles and proportions of the blade, and is not connected in any precise way with the effective pitch or mean experimental pitch.

The following is a key to the symbols used in the illustration, Fig. 73:

$V$  = translational velocity (ft. per sec.).

$v_1$  = inflow velocity forward of blades.

$v_2$  = additional velocity rearwards.

$v_3$  = slip velocity.

$D$  = full diameter of prop.

$d$  = diameter at any section.

$n$  = number of revolutions per second.

$\alpha$  = angle of attack between no-lift line and direction of relative wind.

$\theta$  = helix angle of relative incoming air.

$A$  = blade—face angle at any section.

$P_0$  = mean effective pitch =  $\frac{V}{n}$ .

$P_0$  = experimental mean pitch or zero thrust pitch.

$P_r$  = blade face pitch =  $\frac{2}{3} \pi D \tan A$ .

Propellers are made in two, three- and four-blade types, the former being the most popular. In order to hold down or utilize the full power of a large engine, it is sometimes necessary to use a three- or four-blade type because a two-blade form, suitable to absorb the power, would need excessive pitch or diameter. A two-blade is the most desirable as it is the easiest to build and balance and the most efficient.

#### THEORIES OF SCREW PROPELLER ACTION

The many theories regarding the principles which govern propeller action may be grouped in either of two classes. To the first may be assigned those which consider the action of the screw upon the medium in which it is submerged, and from the movement of the elastic medium deduce the reaction upon the propeller. To the second class belong the theories which consider only the action of the medium upon the propeller.

#### THE DISC THEORY

The "disc" theory is a notable example of the first class, and considers that the propeller displaces a quantity of the medium in which it turns equal to the propeller diameter, and



that given a given amount of fluid having a certain change of velocity impressed upon it, the reaction resulting can apparently be calculated at once from the known density of the fluid. This method would possess a beautiful simplicity if we knew the exact effect of a propeller upon the fluid it passes through, and if the propeller blades were frictionless. Some authorities have assumed that a screw propeller gave to a column of fluid having a sectional area equal to the disc swept by the propeller a sternward velocity corresponding to the slip, but it would appear that in theories of the first class a change of pressure of the medium in motion is of just as much importance as a mere consideration of change of velocity of the fluid acted upon.

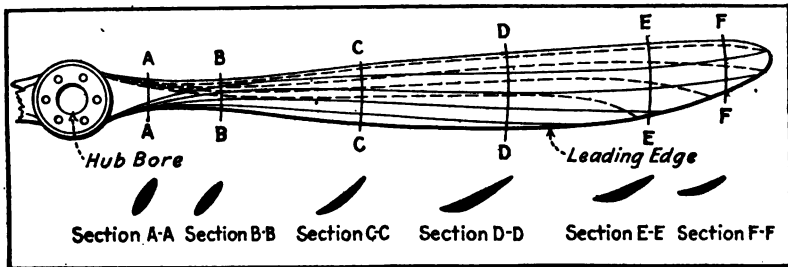
#### THE BLADE THEORY

In the "blade" theory, typical of the second class, the face of the propeller blade is treated as if it were made up of a number of small inclined planes advancing through the water, and it is this hypothesis that most authorities seem to favor. As will be obvious, if the blade surface were treated as an inclined plane, the medium could be considered as imposing a thrust upon the surface which would vary with the density of the medium and the angle of inclination of the plane as the blade moved through it. Despite the variance of theories it is evident they all bring out the same fact, and that is, that rotation of a screw in a suitable medium will produce movement of both screw and fluid in which it is submerged. If the screw is held so that it can move only in a rotary direction the column of fluid it sets in motion will only move. If the screw is operating in an immovable medium, the screw will move in a direction parallel to its longitudinal axis. If both screw and fluid are free to move, the degree of movement will depend upon the "slip" between the screw and the medium in which it works.

#### PROPELLER DEFINITIONS

Before considering the constructional features of propellers used for the propulsion of aerial craft, it will be well to give some brief definitions. A right-hand propeller is one that

when viewed from the rear, turns with the hands of a watch when driving the machine to which it is fitted ahead. Under similar circumstances a left-hand propeller turns against the hands of a watch to produce forward movement. If a right-hand propeller is turned toward the left, the effect will be to produce a reverse movement of the object to which it is applied. The "face" of a blade is the practically straight back surface, that which drives the fluid back while the screw is going ahead. The "back" of the blade is the side opposite the face, and care must be taken to avoid confusion of terms, from the fact that the "face" of a blade is aft and the "back"



**Fig. 74. How Propeller Blade is Shaped at Various Stations along Blade. Note Aerofoil Section at Different Points and Lessened Angle of Incidence as the Tip is Approached.**

forward. The back of the blade is usually a cambered surface, as shown at Fig. 74.

"The leading edge" of a blade is the edge which cuts the fluid first when the screw is turning ahead, while the "following edge" is opposite the leading edge. The "leading edge" is usually curved more than the "following edge." The "diameter" of a screw is the diameter of the circle described by the tips of the blades. In symmetrical two- and four-bladed screws it is simply the distance from the "tip" or outermost part of one blade to that of the opposite member. The "pitch" at a given point of the face is the distance from the axis of the shaft which an elementary area of the face at the point, if attached by a rigid radius to the axis, would move during one revolution, if working in a solid fixed nut. The pitch may be different at every point of the face. If it is the

same at all points we say that the pitch is "uniform." If the pitch is greater along the following than the leading edge, it is said that the pitch "increases axially," and if it grows greater as we leave the center we say the pitch "increases radially."

The "area" or "developed area" of a blade is the surface of its face, and the "blade area" of a screw, sometimes called its "helicoidal area," is the amount of face surface of all its blades. The "disc area" of a propeller is the area of a circle described by the tips of its blades. The "boss" of a screw is the cylindrical center to which the blades are attached, and the "hub" is the metal clamp by which it is attached to the revolving shaft. When a propeller is working with "slip" it advances during each revolution a distance less than the pitch, the difference between its actual advance and the pitch indicates the amount of slip. The "speed" of the screw is the distance it would advance in a unit of time, supposing it to be working in a solid nut. This is obviously equal to the pitch of the screw multiplied by the number of revolutions per unit of time.

The empirical rule that is followed usually in designing either wood or metal propellers having two blades for use in air is as follows: The diameter should be as large as possible compatible with the limits of design; the blade area should be from 10 to 15 per cent. that of the area swept; the pitch should be approximately four-fifths the diameter, and the speed of rotation should be small, never more than 1500 revolutions per minute. As the speed of rotation is increased, the diameter must be reduced. Maximum thrust effort will be obtained with large diameter and low speed.

#### PROPELLER MANUFACTURING PRACTICE

Airplane propellers are usually made of wood because this material is the one that has the greatest strength in proportion to its weight and has been found to be the best adapted. Commonly used woods in American manufacturing practice are Honduras mahogany, birch and white oak. Spruce, maple, cherry, ash and poplar are sometimes used. English practice favors mahogany and black walnut, their preference

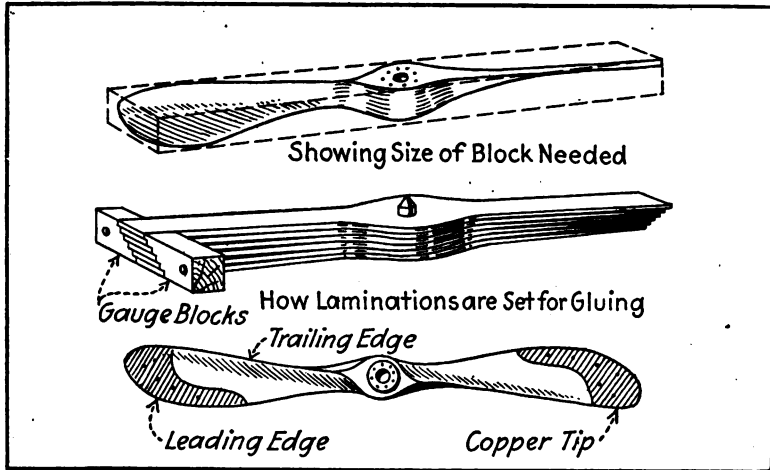
seeming to be for the latter. Spruce is used for the manufacture of propellers for small engines to some extent. This wood has the advantages of being light and strong, as well as easy to glue, and climatic conditions do not affect it unduly. This wood is seldom used in propellers for engines of more than 60 H.P. Propellers to absorb 100 H.P. have been successfully made with alternate laminations of maple and spruce, with the layers so arranged that the hard wood comes on the outside to better resist the compressive effect of the metal hub plates and flange.

Mahogany is comparatively light and is not difficult to glue. It is a soft wood, however, and easily marred. Quarter-sawed white oak has a high tensile strength, but unless absolutely dry stock is used some trouble will be encountered with the glued joints. The reason the quarter-sawed is used in preference to the plain oak is that the latter is apt to develop season cracks. In propellers for engines of 200 H.P. or more, birch has been used very successfully because it is tough and strong in resisting tensile strain and is not unduly heavy. Its disadvantages are that it is affected easily by changes of weather and will warp or check, especially when thin sections are used. For extreme climatic conditions, such as encountered on the Mexican border, mahogany or poplar has given good satisfaction. Ash is not recommended if mahogany or walnut is obtainable, because it is difficult to laminate it or work it on account of its tendency to splinter. Quartered white oak is an excellent material for use in connection with propellers for large engines.

Any airplane propeller, except the very small ones used for operating fuel feed pumps, electric dynamos for radio, etc., is made up of a number of laminations. In the early days, airplane propellers were made from a solid piece of timber, but this practice was discontinued on account of the difficulty in keeping these in condition. A laminated propeller will not warp or draw out of shape as quickly as a one-piece propeller will. Each lamination is balanced separately, and as the block from which the propeller is to be shaped is built up in the press it is customary to lay the heavy end of one ply alongside the

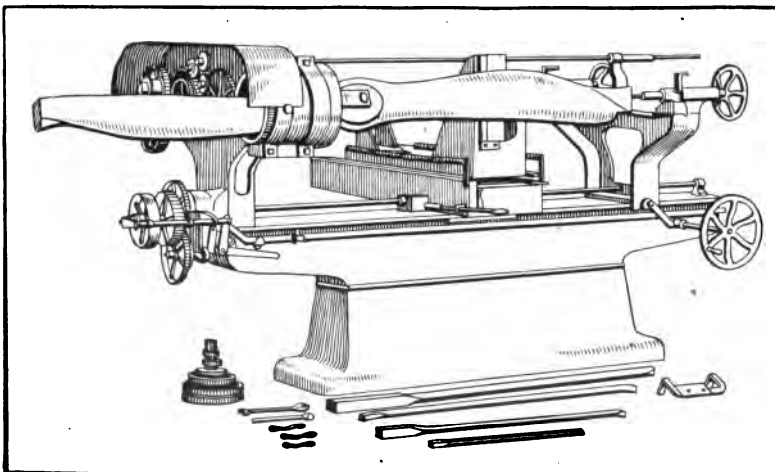
light end of the next layer and in this way a fairly well-balanced propeller blank is obtained.

There are two methods of gluing up the laminations. Straight material may be glued into a rectangular block and

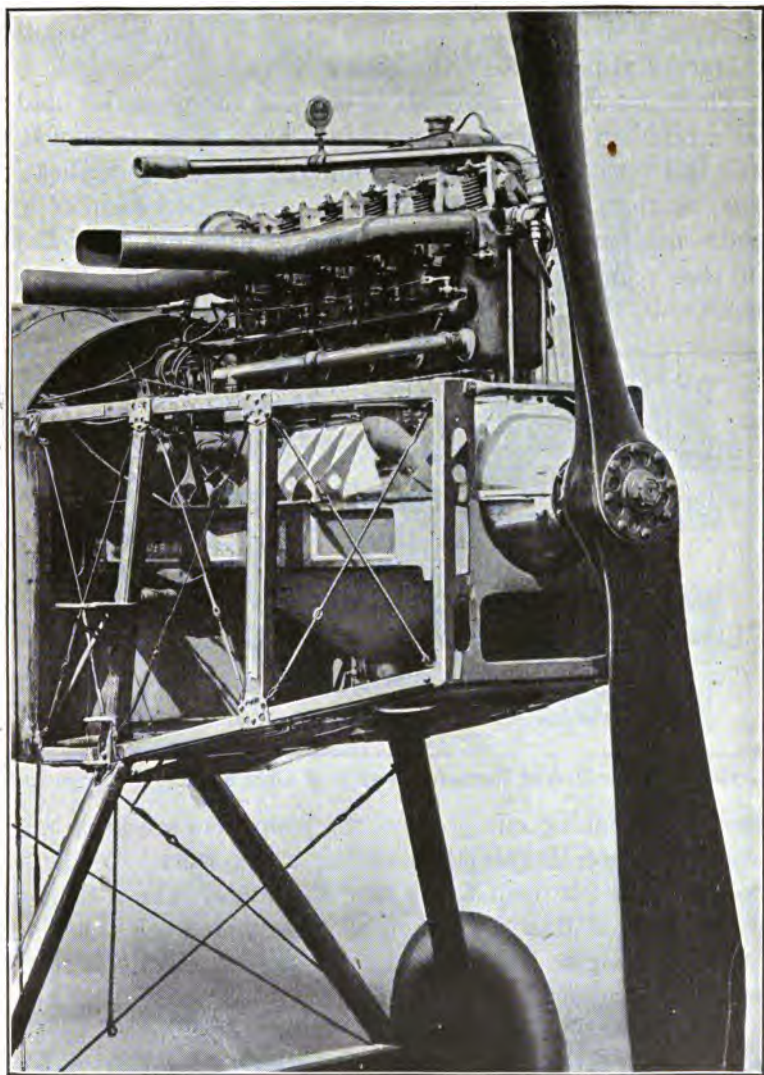


**Fig. 75. How Laminations are Glued Together to Make Block from Which Propeller is Formed.**

roughly band-sawed out to shape, or it may be made of laminations that have been sawed, rough bored and aligned for pitch by means of templates as shown at Fig. 75. The best care is



**Fig. 76. Special Lathe for Turning Out Propellers.**



**Fig. 77.** Installation of Direct Driven Tractor Screw Which Turns at Engine Speed.

taken in the gluing process, and good hide glue to which various chemicals are added for water-proofing purposes is used. Needless to say, the wood must be absolutely dry before gluing, and the laminations must be firmly clamped together in a powerful press while the glue is setting.

There are various methods of shaping the propeller blades, and a number of ingenious machines have been developed to do this work. The machine commonly used is a duplicating lathe, as shown at Fig. 76, which is a modified form of axe-handle machine. A model propeller is used over which the cam that regulates the travel of the cutters operates, and this shapes out the propeller to nearly its finished dimensions.

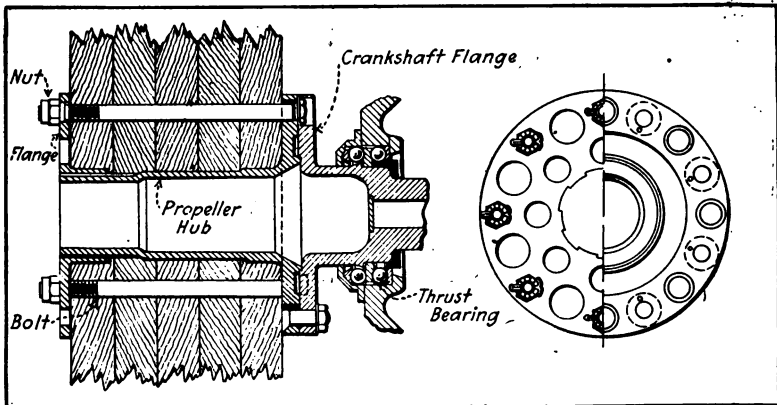


Fig. 78. Propeller Hub of German Design is of Light but Strong Construction.

After this roughing out process, the propellers are hung along a wall or stored in special rooms for a few weeks so that the wood may adjust itself to its new shape and take a final set. The finishing is done by bench workers who work the blades to size with draw knives, spoke shavers, small planes, wood rasps and hand scrapers.

After the propeller is finished, it is carefully sand-papered and polished, the bore is reamed to fit the hub and the finished propeller is tested for balance and alignment. A high-grade piano finish is put on in the finishing department, where a coat of wood filler is applied and well rubbed down, this being followed by the application of three coats of water-proof spar

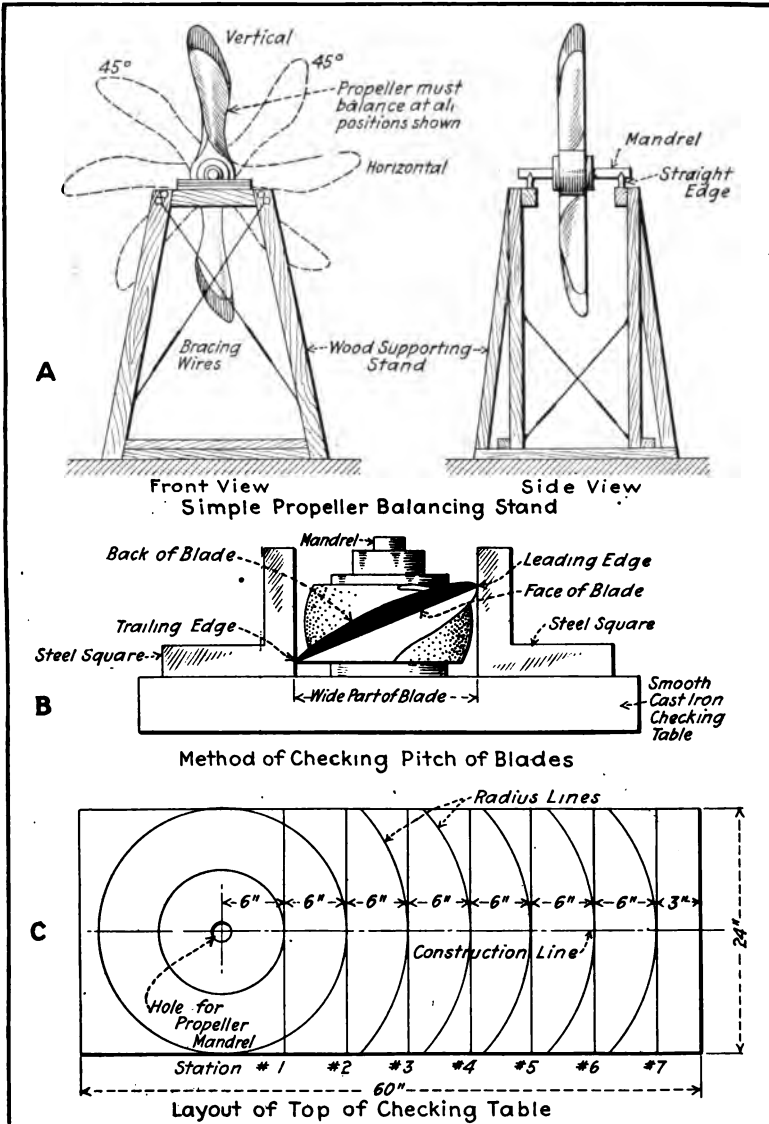


Fig. 79. How Propellers are Tested for Balance and Blades Checked for Pitch at Various Stations.



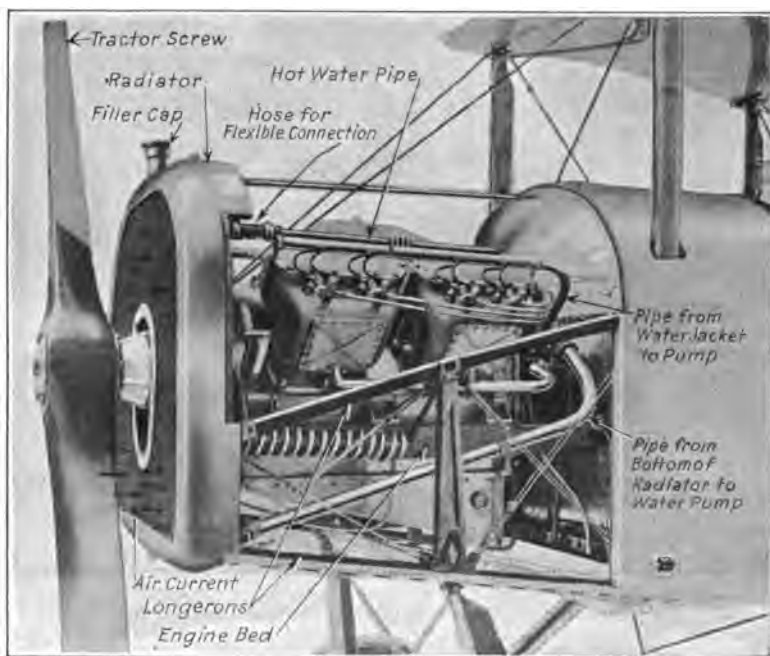


**Fig. 80. Stand for Balancing Propellers.**

varnish. Some propellers are tipped with sheet metal, which tips are securely riveted into place in order to strengthen the thin propeller blade at the point, and also to reduce the danger of splitting. Sometimes propeller blades are covered with a layer of airplane linen, which is stretched tightly over the tips and given three or four coats of "dope," which shrinks it tightly and makes it stick to the blade. The balance of a propeller should always be checked after tipping.

#### HOW PROPELLERS ARE BALANCED

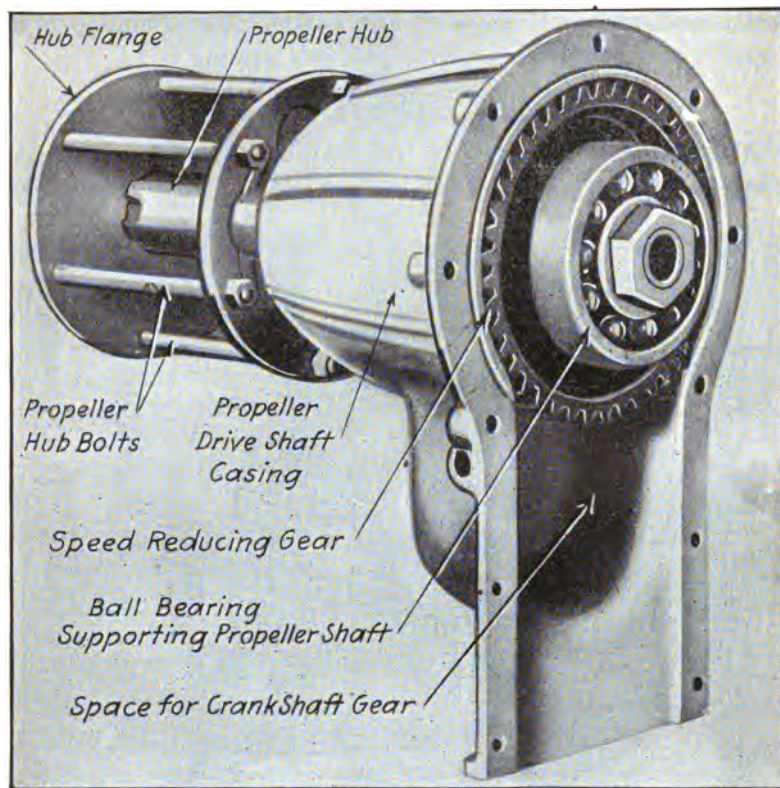
A propeller is balanced by the simple fixture comprising a stand, as at Fig. 79 A, having a pair of straight edges which



**Fig. 81. Propeller Driven at Slower Speed Than Engine by Reduction Gearing.**

support the mandrel and which are carried high enough to allow the propeller to rotate clear of the floor. The supports should be adjustable so they can be accurately leveled. A propeller should balance in any position in which it is placed, *i.e.*, it should not rock back and forth or move when it has

been placed in any position. Endeavor is always made to balance propellers in a room free from air currents. Each blade should be balanced in vertical, horizontal and 45 degrees each side of the vertical position. The entire propeller should be rotated so that each blade will receive both top and bottom

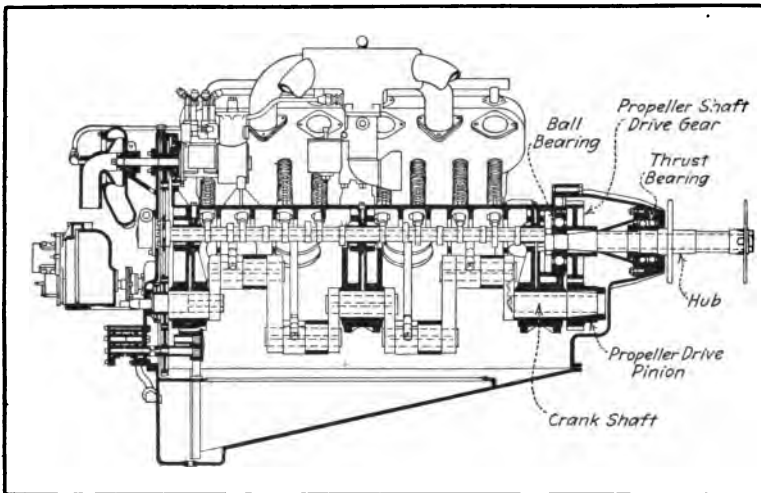


**Fig. 82.** Showing Arrangement of Geared Down Propeller Drive.

position. If a propeller does not balance, it is usually because there is more wood on one side than on the other. Copper-tipped propellers are easily balanced by peening in the soft metal, filling the depression with solder and scraping off the surplus metal until the proper degree of balance is obtained. Untipped propellers are balanced by removing the surplus material. This is always done by taking wood from the back

of the blade, and extreme care is necessary not to destroy the contour of the section.

After the propeller is balanced, it is stored away until needed. Before being used, it is customary to check the pitch of each blade to make sure that they coincide at similar stations. A station is merely a point on the blade at intervals of six inches from the hub center. The blades are checked with a bevel protractor which gives the angle, or by the use of two squares, in which case accurate measurements are taken. A



**Fig. 83. Sectional View of Airplane Engine Having Reduction Gear Drive for Propeller. Engine Runs at 2000 R.P.M. in Order to Develop Maximum Power; Aerial Screw Turns at 1500 R.P.M. for Greatest Efficiency.**

cast-iron surface plate, accurately planed, is used for this purpose, as it is necessary to have a true surface to make accurate comparisons possible. When a bevel protractor is used, the pitch should not vary more than a quarter of a degree. It is important that both propeller blades be the same length in order to secure a well-balanced job. As propellers are designed the pitch is not the same at each station, so in checking up the same station is chosen on each side of the blade, generally at the widest portion, and the measurements taken at that point.

Propeller maintenance is an important point to consider. Propellers should be cleaned and polished with shellac and oil

at the conclusion of each day's flying. The polish is composed of about six parts of shellac to one of linseed oil, which is applied to the propeller with a cloth and vigorously rubbed to a glassy finish with a piece of cheesecloth. If the machine is to stand out in the sun or weather for any length of time, the propeller should be covered with a canvas cloth or with especially made boot to fit it. This prevents checking of the wood and warping or blistering of varnish due to the heat. As long as the finish is properly maintained, the propeller is not apt to absorb moisture.

## CHAPTER IX

### AIRPLANE EQUILIBRIUM AND CONTROL PRINCIPLES

**Factors Regulating Equilibrium and Stability—Why Small Control Surfaces are so Effective—Control Methods of Early Airplanes—Standard Control Systems of To-day—The Function of Balanced Control—Why the Airplane is Banked in Turning—Instruments for Navigating Airplanes—Suggestions for the Student in Flying—Run Motor Slowly to Warm It—How to Take Off—How to Attain Altitude and Handle Machine—Precautions When Landing—Danger in Stalling—Control in Making Turns—Flying Learned Only by Practice—Important Hints.**

THE reader is undoubtedly familiar, in view of the matter previously discussed, with the general principles involved in airplane sustentation and balance. The various parts of the machine have been outlined fully and the functions of the different control elements should be well recognized. Before describing the two most popular control systems it may be well to go a little deeper into the subject of airplane stability. Aircraft must be capable of movement in three dimensions, and it will be seen by reference to Fig. 84 there are really three axes about which the airplane may move. The longitudinal axis indicated by the line *XX* is the one that passes from the front to the rear of the fuselage. The lateral axis indicated by the line *YY* passes from wing tip to wing tip. The vertical axis *ZZ* passes through the center of gravity of the machine and is the pivotal point about which the yawing movement takes place. This movement is controlled by the vertical rudder which is inclined to one side or the other so that the air pressure against it will cause the tail of the machine to swing toward the side opposite to that to which the rudder is inclined. The lateral or *Y* axis is the one about which a pitching movement takes place, this being controlled by elevator flaps which regulate the rise and fall of the tail about the axis *YY*. Whenever the ailerons are operated a rolling motion of the machine takes place with the axis *XX* as the pivotal line for the lateral movement.

The important condition that must be observed to secure the steady support of any plane body in the air is that there be a coincidence between the centers of pressure and gravity, or at least that these have such relation to each other that any additional forces brought into play be counterbalanced. As we have seen, the effect of air in motion under an inclined cambered plane, or the motion of an aerofoil through the air, is

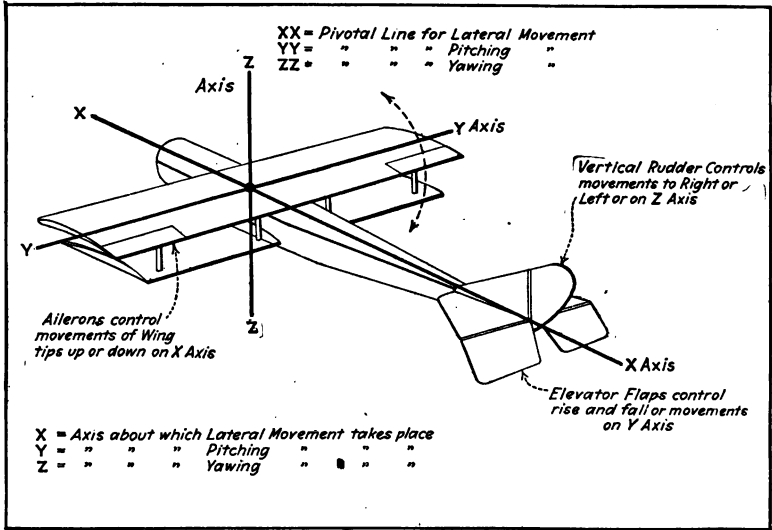
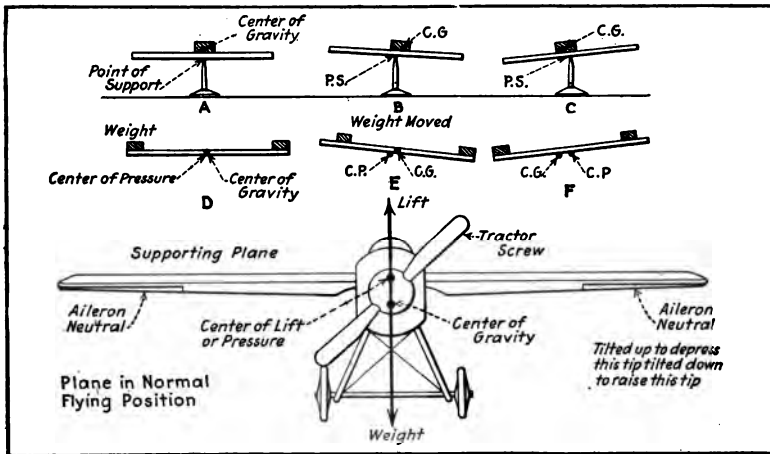


Fig. 84. A Diagrammatic Representation of the Three Axes about Which Movement of an Airplane in Flight May Take Place.

to create certain positive and negative pressures which up to a certain point vary as the angle of inclination of the plane with the relative wind and the velocity of the plane movement through the air. Some of the conditions which must be observed in securing equilibrium are clearly outlined at Fig. 85.

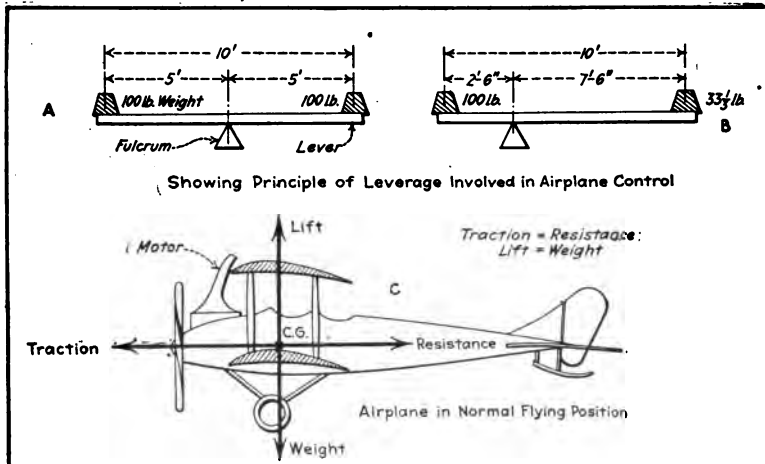
As the diagram at C, Fig. 86, shows, there are four different forces acting upon an airplane while it is in flight. The attraction of gravity, which is represented by the total weight of the machine, acts downward from the center of gravity of the body. The lift is the force opposed to and equal to or exceeding the weight force and acts in the opposite direction or upward. This lift is, of course, created by the supporting

action of the wings or some of the other parts of the machine and acts upward through the center of pressure. As has been



**Fig. 85.** At the Bottom is Seen the Effect of the Opposite Forces of Lift and Gravitation to Which an Airplane is Subjected in Normal Flight. The Diagrams at the Top Show the Effect of Shifting the Center of Gravity Relative to the Point of Support.

previously explained, there is a certain resistance offered by the whole machine which is due to both the unavoidable



**Fig. 86.** Illustrating the Action of Traction, Resistance, Lift and Gravity On An Airplane. At the Top Is An Illustration of the Part Which Leverage Plays In Airplane Control.



resistance met with in forcing the lifting surfaces through the air and the parasitic resistance (which can be reduced by skilful designing) which is due to the non-lifting portions of the machine, such as the struts, landing gear, bracing wires and skin friction of the fuselage. This force is represented by the line of resistance and it acts through the center of resistance. This must be overcome by the traction or pull of the propeller in a tractor biplane and by the push or thrust of the propeller in a pusher type machine, which force acts through the center of thrust. When an airplane is in normal horizontal flight, it is evident that the traction must equal the resistance or be greater than the resistance and the lift must equal the weight or be greater than the weight. To secure a balance or have the machine in a condition of equilibrium at all times, the forces must meet at the center of gravity of the airplane or the disposition of the centers of thrust, gravity, pressure and resistance in relation to each other must be so that balancing forces will be present. It is not within the purpose of a discussion of this nature to go very deeply into the subject of forces and movements, but it may be well to secure an understanding of some of the simpler rules that must be considered in connection with the arrangement and location of the control surfaces.

We can assume that there is one point on the airplane structure where the sustaining effect will be centered and, as shown in the lower portion of Fig. 85, this would be on the line of the main wing spars at the center of the fuselage and is usually known as the center of lift or pressure. The center of gravity is that point in a body where all other parts acted upon by the attraction of gravity balance each other about it in every position. The force of gravity acts in parallel lines on every part of a body regardless of its shape and therefore the center of gravity must be that point through which a resultant of all these parallel forces is directed in every position of the body. If one considers a ball or sphere of uniform density, the center of gravity would be exactly at its center. The location of the center of gravity in irregular shaped objects depends upon where the greater portion of the weight

lies. Naturally it will be nearer the heavy parts than the light parts. If one considers the sketch of the airplane shown at Fig. 86 C, which shows a side view, the approximate location of the center of gravity may be readily determined. It is near the front end of the machine because the power-plant and fuel tanks, which are the heaviest parts, are carried at that end.

#### FACTORS REGULATING EQUILIBRIUM AND STABILITY

To secure stable equilibrium of any body the point of support must coincide with the center of gravity. In considering the support of a body having three dimensions we must accept the base at that area on a horizontal plane which is comprehended by lines joining the extreme points of contact. Thus, the base of a box would be represented by a rectangular area while the point of support of a steel ball on a non-yielding surface would be a point. The larger the base the more stable a body is. The slightest touch will set a ball rolling, while it takes considerable effort to disturb the equilibrium of a box.

If a vertical line drawn from the center of gravity, which line is known as the line of direction, falls within the base of the body, it is said to be in stable equilibrium. If it falls at or near the edge or base of the body, it is in unstable equilibrium, and the slightest force will cause overturning. This point can be readily demonstrated by tipping a box so that it will stand on one of its edges instead of on its side or base. If the line of direction falls outside the base, the body is not supported.

What is true of a body supported on some solid substance applies just as well to a plane supported by air reaction. This point can be made clear by examining the illustrations at top of Fig. 85. In this case a pivot is used as a point of support and a block is carried by a plate which is supported by the pivot point. At *A* the center of gravity is directly over the point of support and the plate is balanced. At *B*, the body has been shifted on the plate, the latter being undisturbed. The center of gravity of the combination is now to one side of the point of support and the plate is in unstable equilibrium.

Referring to *D*, instead of being supported by a solid pivot point, the plate is supported by air and two weights are provided, one at each end. If the weights are so placed that their centers of gravity are the same distance from the center of the plate, the center of gravity of the combination will be at the center of the plate. The center of pressure, due to air reaction, will be at the same point and the plate will be in a condition of equilibrium. As shown at *E* and *F*, moving the weights will change the center of gravity in relation to the center of pressure and cause tipping of the plates. The airplane shown at the bottom of Fig. 85 has the center of lift or pressure directly above the center of gravity and the machine, when in normal flying position, is in a state of equilibrium.

As has been previously indicated to some extent, there is a variation in the air pressure upon a plane which cannot be absolutely determined on account of changes in wind movement and temperature. The air itself is never at rest. It moves upward as it becomes heated and moves down as it is cooled and moves sideways, depending upon configurations of the earth's surface which, of course, varies according to locality. There is nothing by which movements or velocity of movements of the air can be predicted or known with certainty for even a brief period in advance. The pressure upon a given area is never constant and, as will be apparent, the center of pressure on an aerofoil will shift constantly and there will be considerable variation between it and the center of gravity.

For example, a gust of wind striking one side of an airplane in a position of equilibrium will produce added lift on that side if it strikes under the wing, and added weight on the side where its force is exerted if it strikes the upper part of the wing. In either case the effect is the same as though the center of gravity were shifted in relation to the center of pressure or point of support, and the airplane will tip. This movement is counteracted by altering the position of the ailerons from a neutral position so that the one on the high side is tilted up so the air strikes its upper surface and pushes the high wing down while that on the low side is tilted down

so the air pressure strikes its under surface and tends to lift the low wing up.

WHY SMALL CONTROL SURFACES ARE SO EFFECTIVE

The reason why an aileron or other controlling surface of relatively small area may give positive control is because it is carried at the end of the wing and considerable leverage is obtained. Referring to the diagram at Fig. 86 A, we have a condition where lever arms are of equal length, *i.e.*, the fulcrum or point of support is just midway between the two 100-pound weights. The combination is therefore in a condition of balance or equilibrium. As shown at B, if the point of support is shifted so that it will be near one end of the lever it will

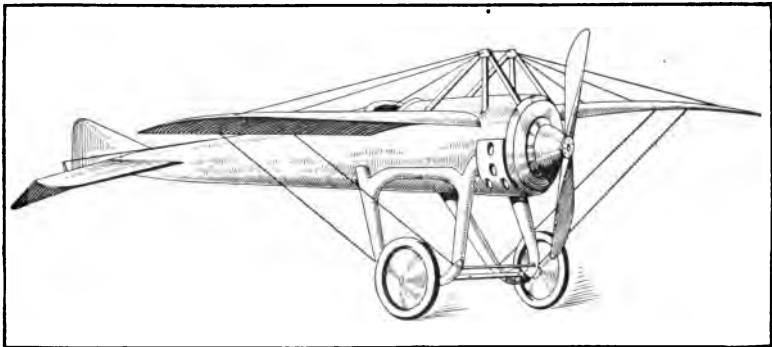


Fig. 87. The Departussin Racing Monoplane of 1912, a Pioneer Form Showing Advantages of Thorough Streamlining to Secure High Speed and Compact in Placing of Weights to Secure Easy Control.

not take as much weight to balance 100 pounds as it did in the case outlined at A, where the weights were equal. When the long arm of the lever is three times the length of the short arm, it will take but one-third of the weight to secure a balance. The actual figures will vary somewhat from those used because in the example the weight of the long arm of the lever itself must be taken into consideration, so that somewhat less than one-third the amount of weight mounted on the short arm of the lever can balance it if placed at the end of the long arm.

In an airplane we have a condition similar to that shown at B. The center of gravity of the machine is near the heavy

end or front, and it will take but little weight or pressure at the end of the long arm to balance the considerably greater weight at the front of the machine. In airplane design we therefore have two classes of planes as illustrated at Fig. 88. The short type airplane is the one adapted for quick manœuvres because the lever arms are short and the control surfaces do

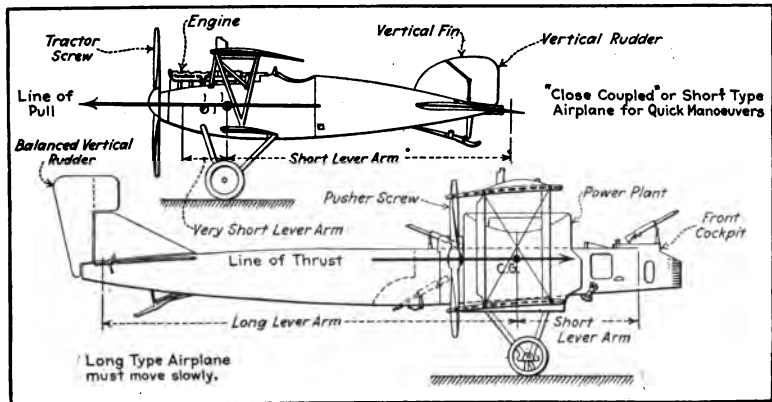


Fig. 88. The Two Types of Airplanes in Use at the Front, Showing the Characteristics of Each.

not have to move as much to produce a given degree of inclination. In the large machines a different disposition of weights, such as produced by having a cockpit for a gunner extending some distance in front of the airplane will call for a proportionately longer fuselage to obtain the required balance. An airplane having long lever arms cannot move as quickly as the close coupled type.

#### CONTROL METHODS OF EARLY AIRPLANES

The system of plane warping which was used in the early Wright creation by which the supporting wings were distorted at the tips is now practically obsolete, and nearly all machines of modern design have ailerons or wing flaps to secure lateral control. Longitudinal stability has always depended on surfaces carried far enough back of the center of gravity so that a relatively small inclination would raise or depress the tail, or, in the case of the vertical rudder, would swing it from

side to side. In the early days there was considerable variation in the methods of actuating the surfaces for securing a change in direction and equilibrium. The movements required to control an airplane in its flight are usually three.

In the early Antoinette monoplane machines steering was by the usual form of rudder bar, elevation was controlled by a hand wheel at the right of the pilot and the lateral balance was controlled by a hand wheel at the left of the pilot. In the Bleriot, steering was by the feet while a single-lever control regulated the elevation by being pushed forward and backward and the wing warping by being moved from side to side.

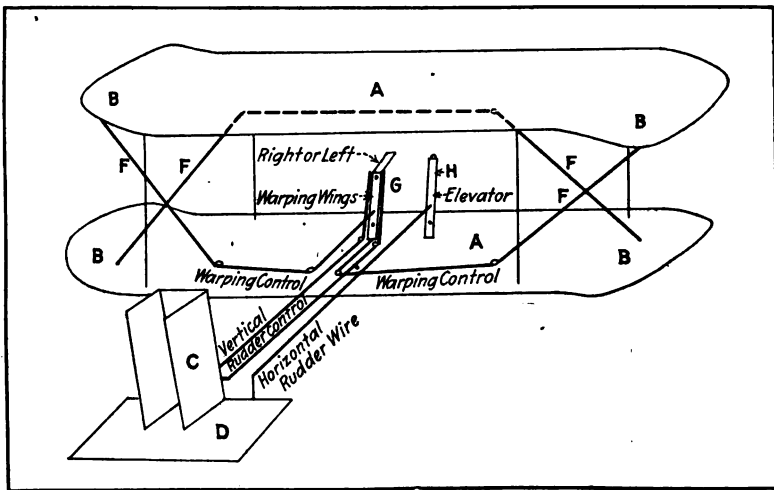


Fig. 89. Diagram Showing Wing Warping Control System on Early Wright Airplane.

This was the forerunner of the present stick control system which is almost universally used on the light, speedy types of aircraft. In the pioneer Wright machine steering and plane warping were controlled by one lever while elevation was controlled by another. The pilot had both hands fully occupied, one at each lever. In the Voisin type machines first built, steering and elevation were controlled by a wheel, the former by turning the wheel and the latter by pushing it and the steering post on which it was mounted, back and forth. Vertical partitions were used between the planes in an endeavor

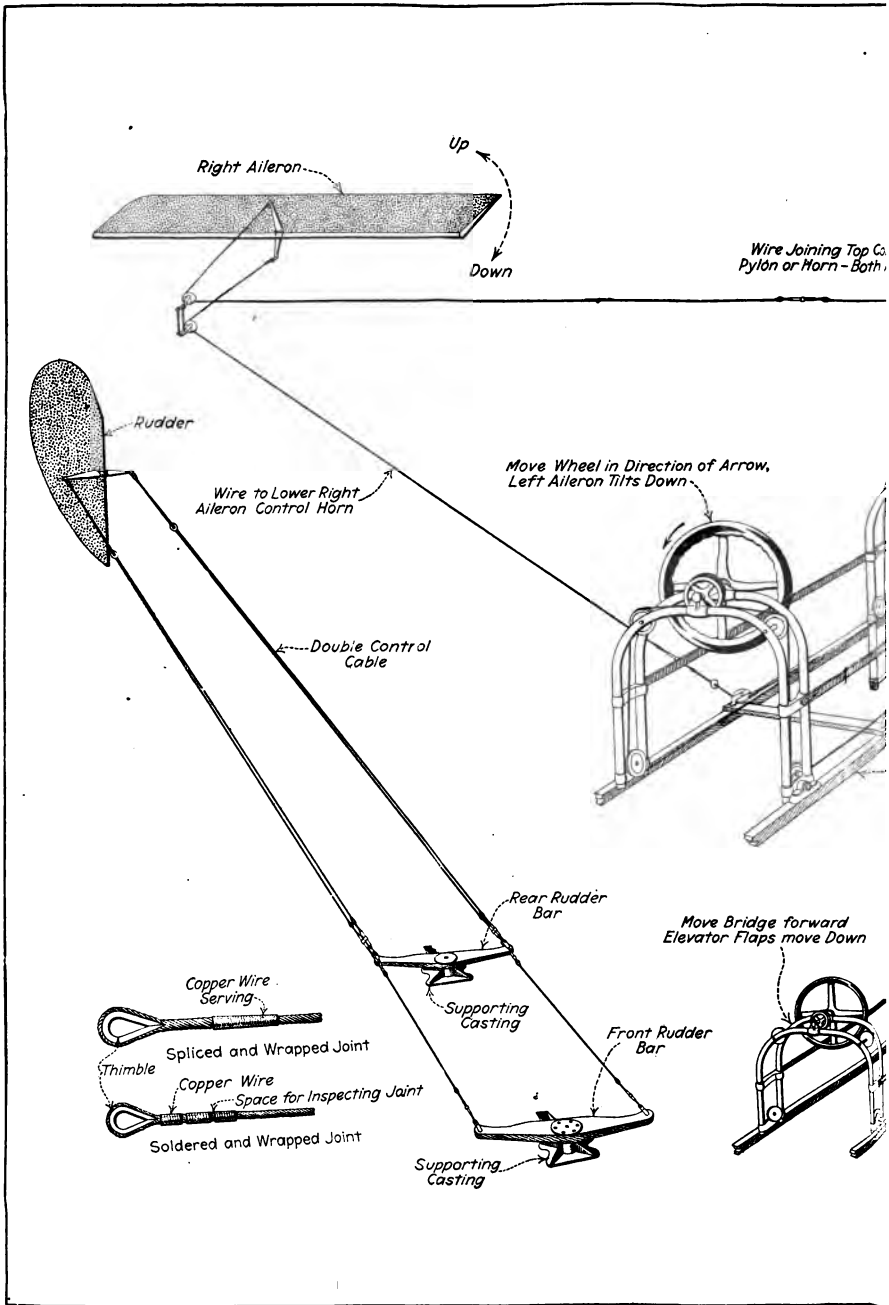
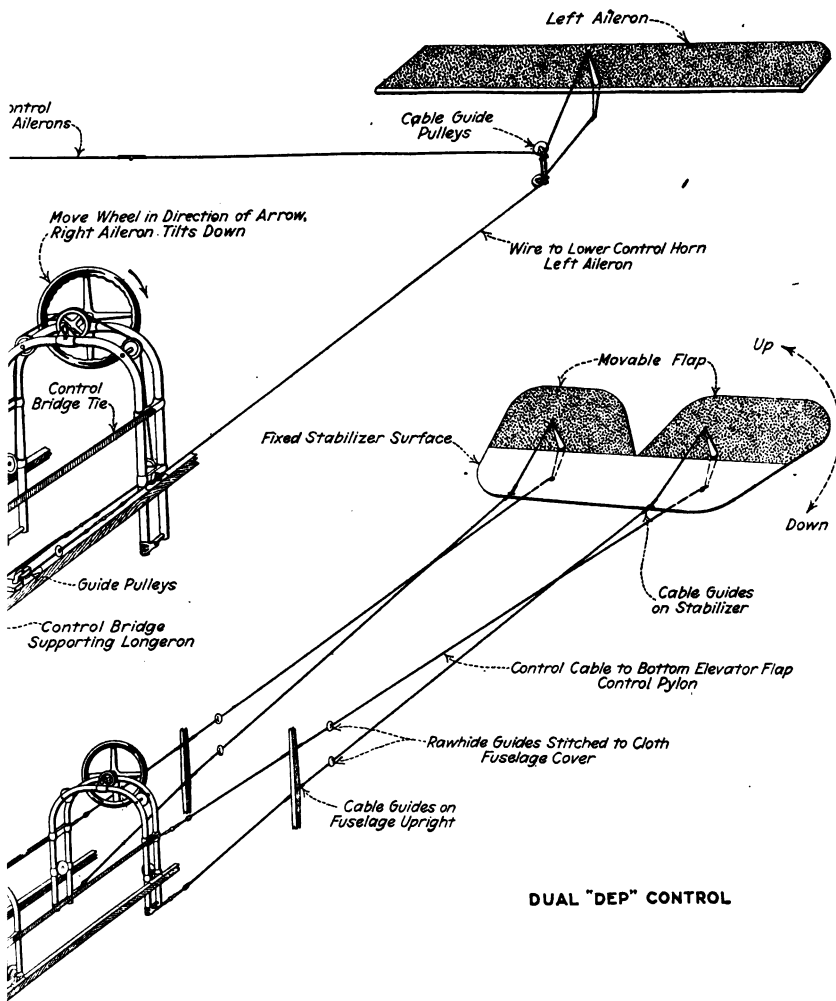


Fig. 92. Dual Dep. Control System Showing



g Wires and Method of Connecting Them.



to vml  
ABSTRACT

In the first Curtiss machines steering was by a hand wheel, elevation was obtained by rocking the steering post back and forth, while the ailerons were actuated by a movable seat back or shoulder rest actuated by the operator's body. It was believed that the operator would lean toward the high side instinctively and by so doing would tilt the ailerons at the high side so the wind would strike the upper surface and move the high side down. (See Fig. 90.)

STANDARD CONTROL SYSTEMS OF TO-DAY

At the present time but two systems of control are used, the Dep., which is an abbreviation for Depardussin, who invented the system, and the simple stick control. The former is shown at Fig. 93. It consists of a hand wheel

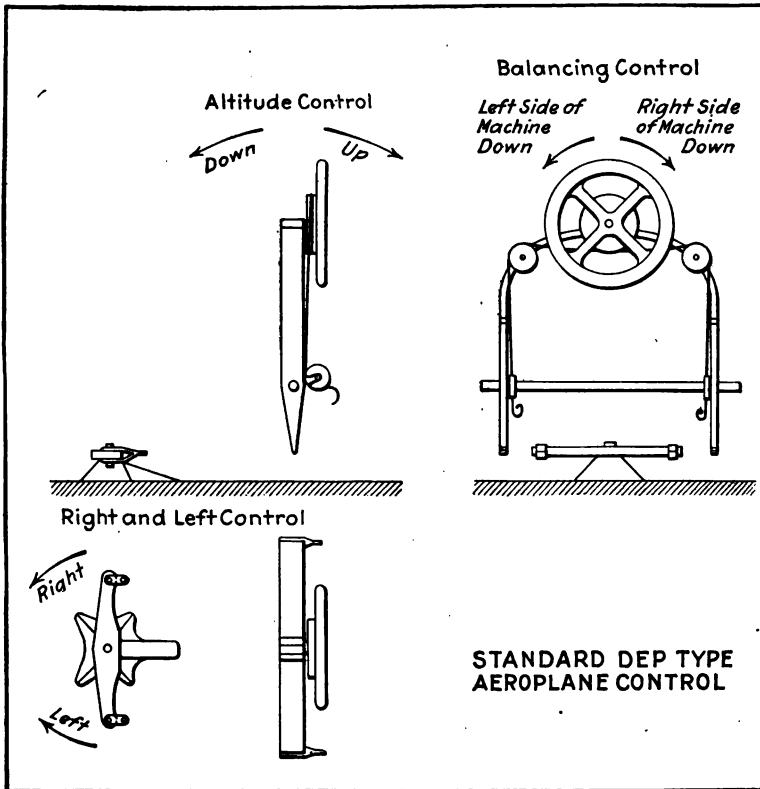


Fig. 93. Elements of Standard Dep. Control System.

mounted on a control bridge, the relation of the parts being such that the hand wheel may be oscillated at the same time that the control bridge is pushed back and forth as desired. The steering on a horizontal plane is obtained by a foot bar. It is pushed with the right foot to make a right turn and with the left foot to make a left turn. The control bridge is pushed forward to make the airplane go down and pulled back toward the operator to make it go up. The balancing control wheel is rocked toward the right side of the machine if the right wing is up and to the left side if the right wing is down. The method of running the control cables to secure the proper

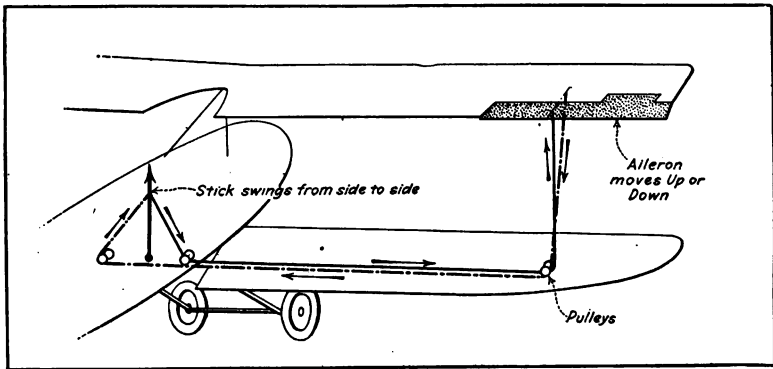


Fig. 95. How Stick Control Operates Ailerons.

movement of the various control elements when the dual Dep. system is used is clearly outlined at Fig. 92.

The stick control system, which is shown at Fig. 94, has practically the same movements as in the Dep. system. Altitude control is secured by moving the stick forward to have the plane go down and to pull it toward the operator to have the plane go up. The balancing control is by rocking the stick from side to side. Directional control on a horizontal plane is obtained by the same type foot bar as used with the Dep. system. The diagram at Fig. 95 shows how the cable may be connected up to operate the aileron by means of the stick. With the hand wheel the cable is passed around the control drum or large hub just as in a motor-boat steering gear.



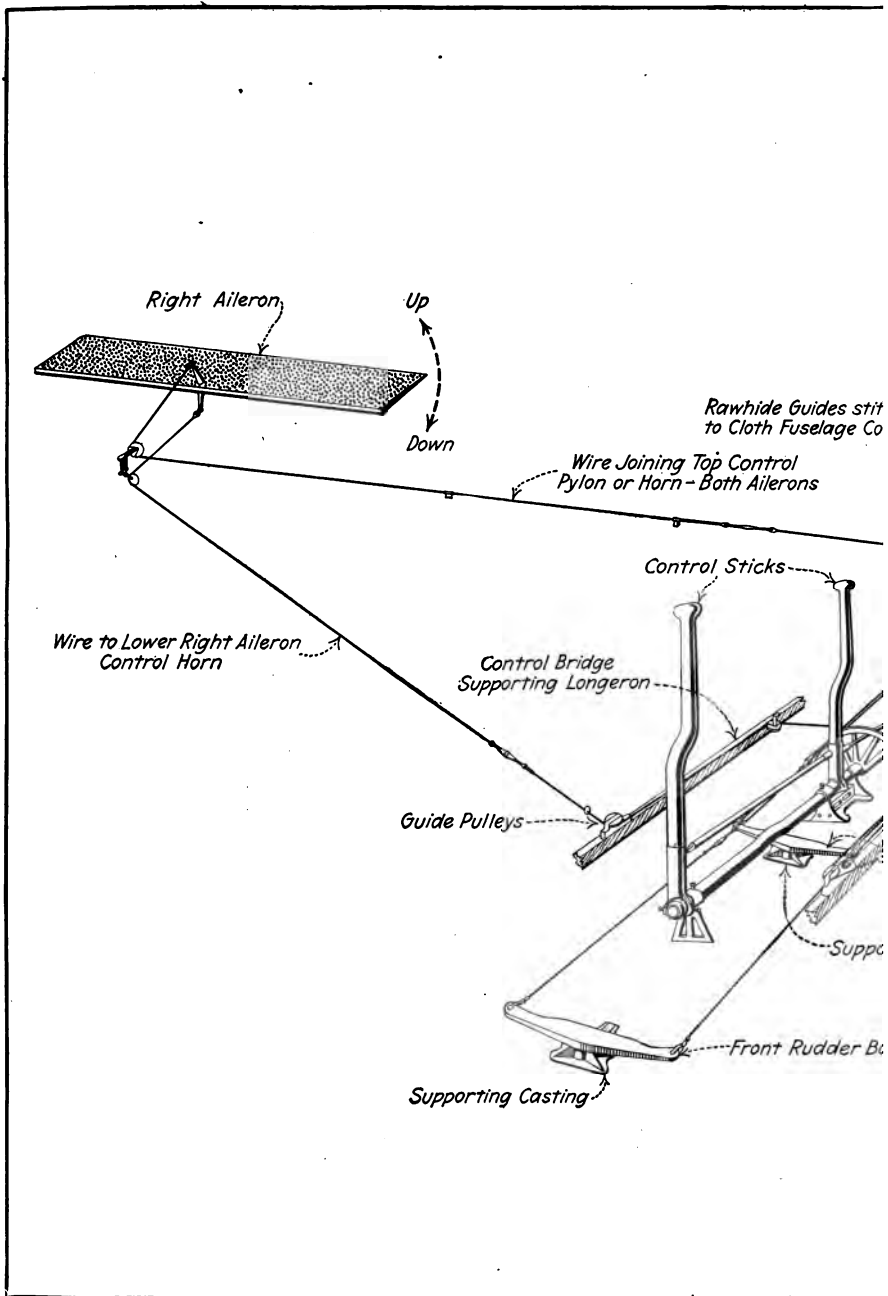
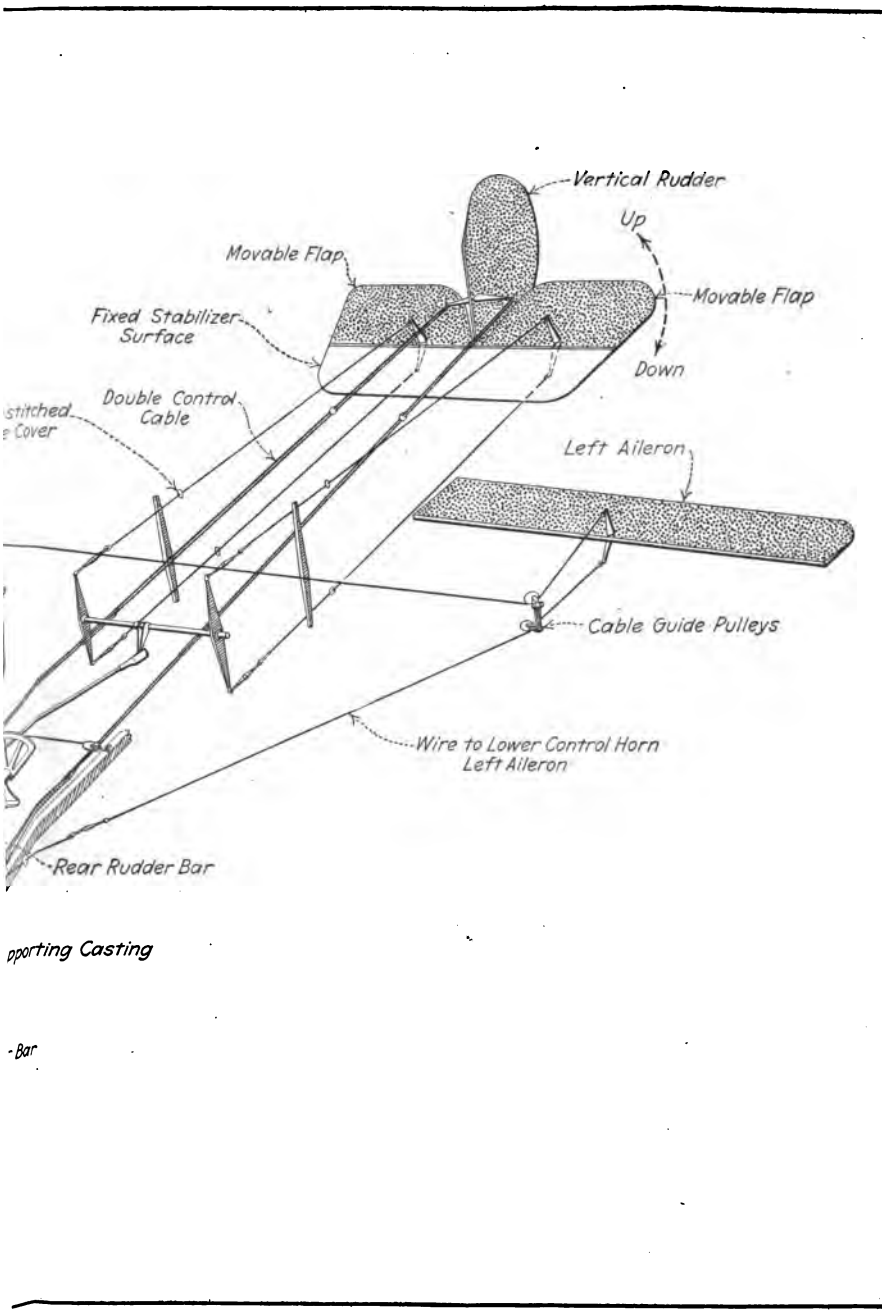
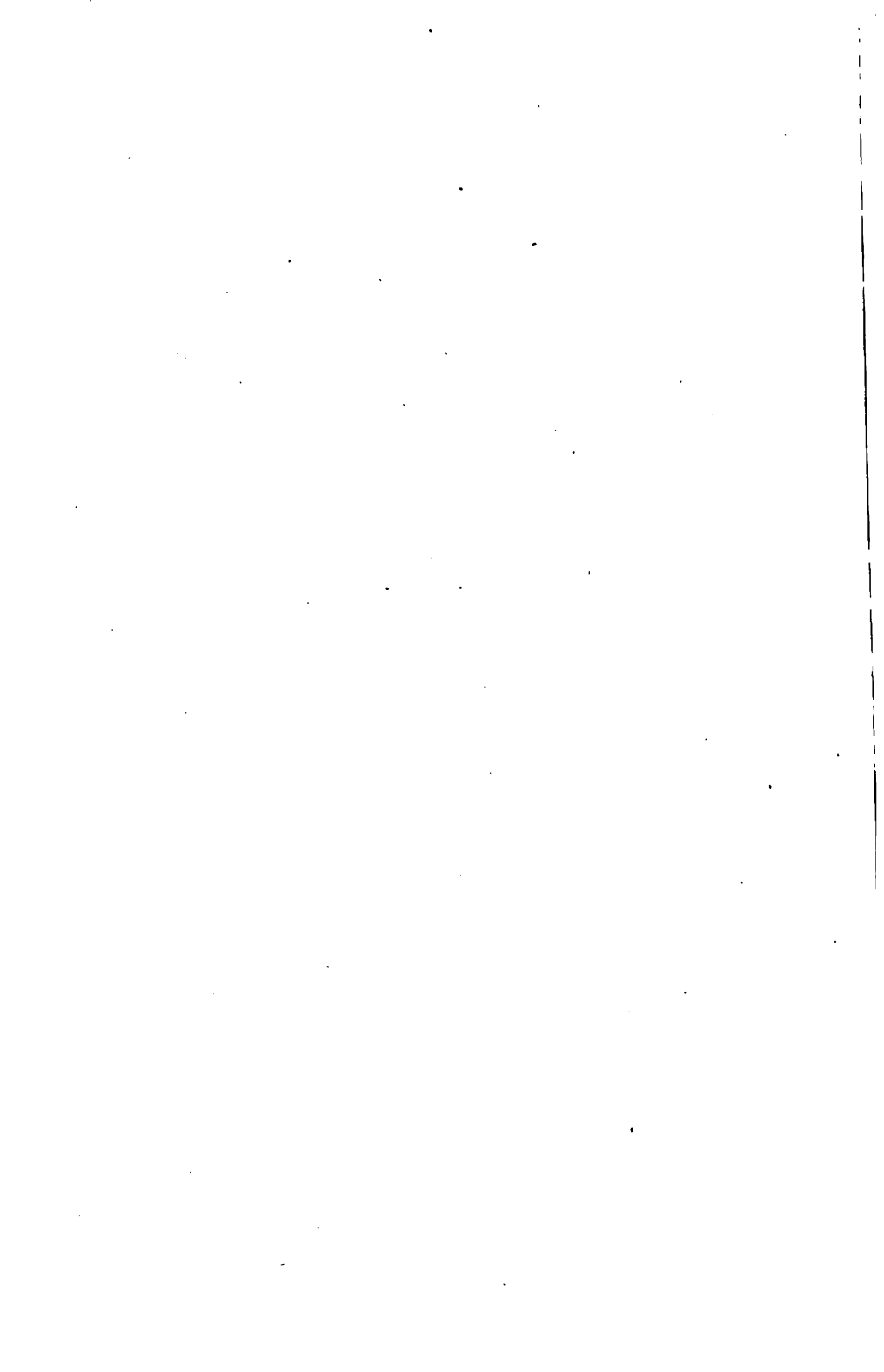


Fig. 94. Dual Stick Control System Sh



Showing all Cables and Control Members.



## THE FUNCTION OF BALANCED CONTROL

In order to secure easier control of an airplane and lessen the amount of force exerted by the operator, some airplane designers provide projections from the main control surfaces which assist the operator in keeping the member in the proper position. The German Fokker triplane, which is one of the most recent productions of the enemy, has these balancing portions on all of the control surfaces. For example, to keep an aileron pressed down against the air reaction requires considerable effort on the part of the pilot, especially on high-speed or large machines. The flap or projecting portion of the aileron, which is on the other side of the pivotal point, receives the air pressure on its lower surface and this force assists the operator in keeping the aileron pulled down. The same thing applies if the conditions are reversed. In this case the air pressure strikes the upper part of the balancing flap and assists the operator in keeping the aileron tilted up.

The action of the projecting portions of the vertical rudder and elevator flaps is just the same as that of the similar parts of the aileron. (See Fig. 96.)

## WHY THE AIRPLANE IS BANKED IN TURNING

Anyone who has ridden a bicycle can appreciate the importance of proper balance, and knows that the faster the speed the easier it is to maintain equilibrium. When rounding corners, the expert rider, by proper inclination of his body is able to turn close and at high velocities, while others less expert must diminish speed and make a wide turn. It is well known that it is practically impossible to turn a corner at speed without inclining the body enough to overcome the tendency to resist change of direction of motion. If we consider the laws of Newton as regards motion, we shall see that the property of inertia is that a body in motion tends to move forever in a straight line and uniformly. Therefore, when turning a corner, by inclination of the body one changes the center of mass enough so that it falls outside of the line of support and both wheel and rider revolve for a brief period



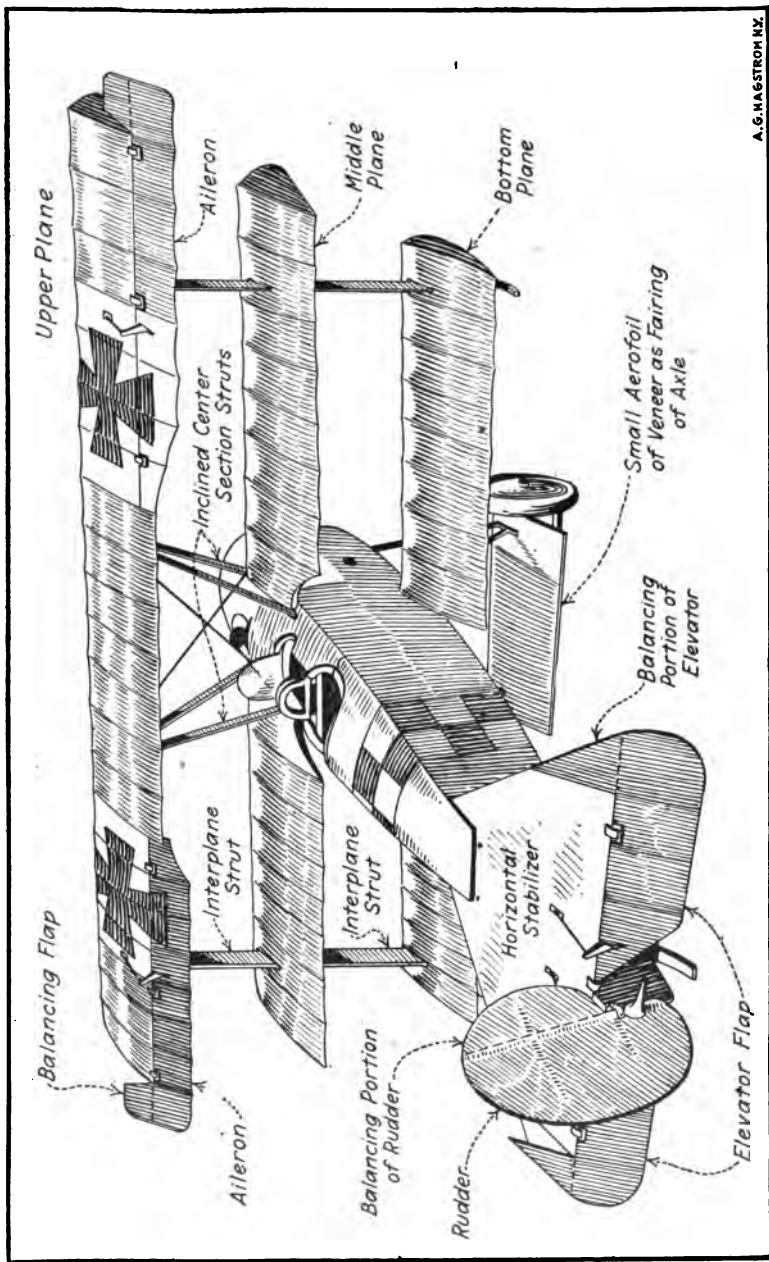


Fig. 96. German Triplane of Recent Design with Balanced Control Members.

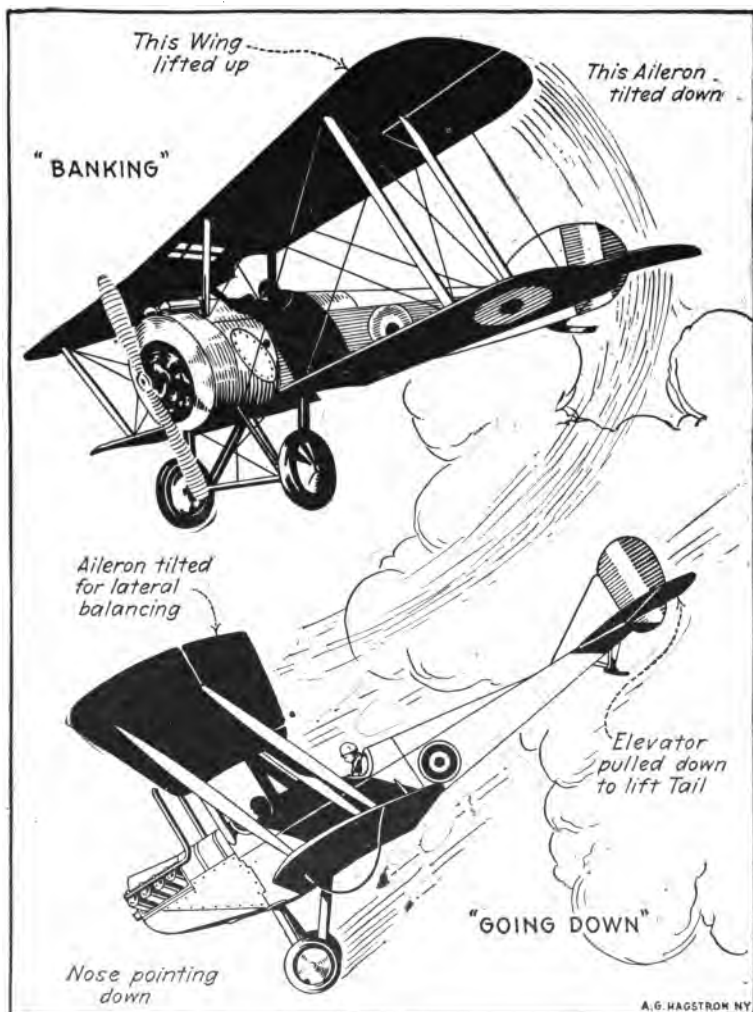
around the center of gravity, until the turning is completed. After which the rider again shifts his body, so that a line drawn through the center of gravity, known as the line of direction, coincides with the line of support, when proper balance obtains travel on a straight line again.

In describing curves with an airplane, practically the same conditions obtain as when riding a bicycle, and suitable compensation must be made for the tendency of the machine to throw its inner end higher than the outer in making the turn. This obviously means a loss of lateral stability, and while the rider of a bicycle can accommodate himself by shifting his center of gravity instinctively, obviously this is not possible with an inanimate piece of mechanism, so the airplane must be "banked" by the lateral control or ailerons if one is to make a turn without "skidding." Any attempt to turn flat, or without banking, always results in a "sideslip."

High motor-car speeds are not possible on a circular track unless it is banked, and speeds greater than sixty miles per hour are hardly possible on circuits a mile in circumference that have practically a flat surface. Motorcycle racing has shown that with a properly banked track high speeds are possible even on small circuits. One can hardly compare the two-point or single-line support machine, such as the bicycle or motorcycle, with either a three- or four-point support vehicle as the tricycle or automobile. In the former instance, the rider's position has material bearing upon the balance, whereas in the other equilibrium at high speed is only obtained by a low placing of the center of gravity and proper distribution of weight. At high velocities even on a flat circular track the cyclist can incline his body and secure practically the same effect as though the track were banked. Obviously this is not possible with a motor-car, and at high speeds the machine skids around instead of running around a corner, unless the track is banked. The faster the speed, the higher up the bank the car must be driven, as a greater angle of inclination is necessary to offset the tipping tendency of centrifugal force.

In considering the flying machine, one can hardly make a consistent comparison with a motor-car, as in this instance

four points of support form a base within which it is not difficult to include the line of direction and secure stability, even at high speeds and angles of banking. In the flying machine,



**Fig. 97. Illustrations Showing How Control Elements are Moved to Regulate Airplane Flight.**

we have theoretically but one center of support, and it is somewhat difficult to secure and maintain equilibrium, even in straight-line flight. We have seen that an airplane is sup-

ported in the air by the reactions which result when one or more plane surfaces are moved edgewise through the atmosphere at a small angle of incidence, either by the application of mechanical power or by utilization of the force of gravity. In the practical creation there must be provided means for securing both transverse equilibrium, and restoring it when disturbed, in addition to the apparatus for guiding the machine both vertically and horizontally. In turning, an airplane should assume practically the same position as a motor-car upon the bank of a track, the outer end being higher than the inner end. In this way air pressure offsets the centrifugal force and "skidding" is reduced to a minimum. The formula in flying is "bank, rudder, rudder, bank," meaning that the control must be actuated in the order named to avoid a "flat turn." The lateral control is operated to tilt the airplane to the proper bank for the radius of the turn and as soon as the banking starts the rudder is operated. In coming out of the curve, the rudder is straightened out before the plane is balanced laterally. Considerable experience is needed to bank the proper amount and a skilled pilot is always known by the manner in which he makes his turns.

#### INSTRUMENTS FOR NAVIGATING AIRPLANES

A typical cockpit of an airplane, showing the various parts comprising the control system, is shown at Fig. 98. The various indicating instruments which assist the pilot in controlling the machine are shown. In this the hand wheel, instead of being mounted on a control bridge, is fastened at the top of a lever which performs the same functions. An air pressure or speed indicator shows the air speed of the machine. An altimeter, which is a form of aneroid barometer, indicates the height of the machine above the ground. A tachometer is employed to show if the engine is turning at the proper speed. The clock indicates time and is very useful when used in connection with a speed indicator in determining distance travelled. Three pressure gauges are provided, one indicates the oil pressure, one the pressure of air in the air starting system used to set the motor going and the third one

the air pressure in the fuel feed system. The switch is used to short circuit the magnetos and interrupt ignition. Throttle and spark levers are utilized to regulate the engine speed. When the pilot is to make a trip of any magnitude a compass is provided in addition to the instruments shown.

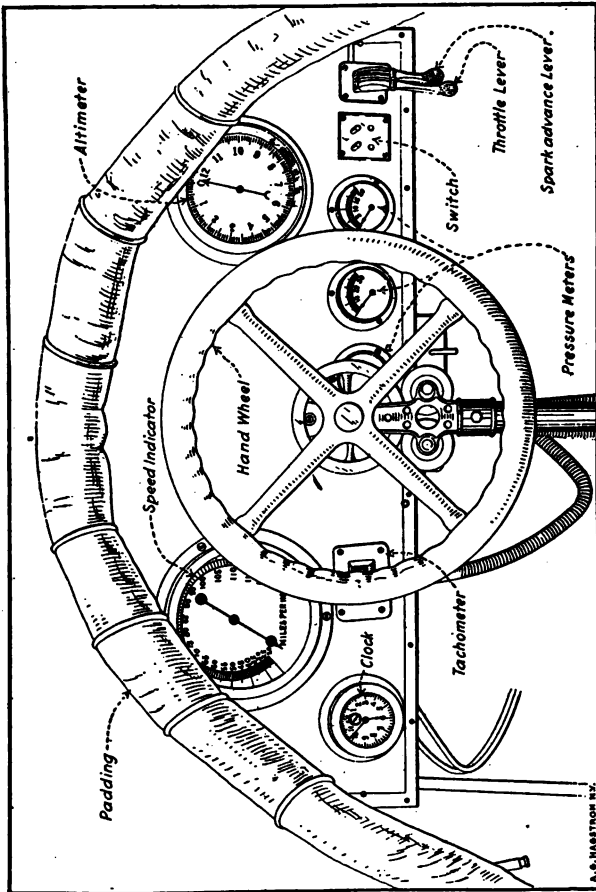
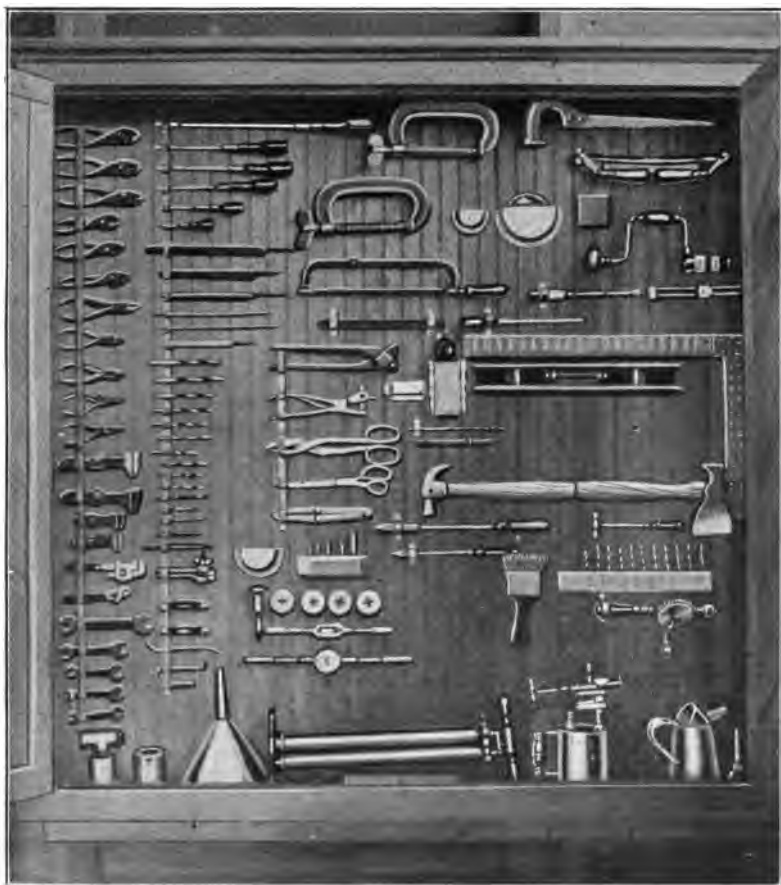


Fig. 98. Showing Instruments to Assist Pilot in Control of Airplane.

**Suggestions for the Student in Flying.**—To begin with, the rules governing the handling of a plane that can be put down on paper are very few, for three chief reasons: First, that no two machines handle alike; second, that no two pilots fly alike; third, that atmospheric conditions change so often. These so-called atmospheric conditions are the things that

are most difficult to overcome; namely, hot and cold currents of air or upward and downward currents of air which have a natural tendency to take the plane to a certain extent in their same direction. We oftentimes hear the student speak of an air



**Plate 2. Complete Outfit of Tools for Erecting and Taking Care of Airplanes. The Outfit Shown is Adequate Equipment for a Crew of Six Men.**

“pocket.” There is no such thing as an air “pocket.” The so-called air “pocket” is merely a downward current of air which has, as above stated, a natural tendency to take the plane in the same general direction.

The things the student learns first are the things he should

never forget. There are two things the student should learn first of all; *i.e.*, always keep flying speed, and always keep in mind what position you are in relative to the wind. Without these two things in mind you cannot properly, or safely, handle your plane—speed, especially, being the greatest factor which is obtained and maintained from two sources, namely, propeller thrust and gliding. In case your primary source of speed ceases with either a known or unknown reason, the immediate thing to do is to nose the plane into a glide, sufficient to maintain flying speed. Don't worry about what the trouble is before so doing, or your troubles will pile up, and so will the machine.

Before starting on a flight look over your machine in a general way to check up on the inspection given by the mechanics charged with its maintenance. Do not take anybody's word that there is enough gasoline, oil and water; check these points yourself. Examine principal control wires and move rudder bar and control stick or wheel in all directions to make sure the control members function as they should.

**Run Motor Slowly to Warm It.**—Let motor run idly until it is warm and oil is circulating properly as indicated by oil pressure gauge. Test engine for revolutions per minute as indicated on the tachometer, but never race the engine for more than a few seconds in determining this. Be sure the wheels are chocked or blocked or that the wings are held by several men to prevent forward motion of the machine when the engine is speeded up. Never run an airplane engine unnecessarily when on the ground, as this reduces the flying time or the service the engine will give in the air. Special attention should be given to the way high compression engines are run on the ground. These should never be run at full throttle on account of danger of preignition; in fact, any excessive running of such engines will result in their quick deterioration.

As soon as you feel sure that the power-plant is functioning properly and that your controls are in good condition, you should taxi to a smooth level spot, with hard, dry ground or short grass that will provide a runway of several hundred

yards in the direction the wind is blowing. Avoid soft or sandy ground or spaces having hummocks or long grass. If in doubt about the nature of the ground have an assistant at each lower wing tip. Watch carefully for the direction of the wind and start off with the full power directly into the wind. The tendency of the machine to turn to the left due to the propeller blast striking the left side of the fin more than the right side is counteracted by right rudder.

**How to Take Off.**—When the machine has attained fair speed, which it will do at about 30 or 40 ft., the tail should be raised by tilting the elevator flaps down by pushing the stick or control bridge forward slightly. This keeps the machine from leaving the ground until it reaches its proper flying speed. When this point is reached, which varies with the construction of the plane and velocity of the wind it is heading into, usually at speeds of 50 to 60 miles per hour, then move the control lever by pulling it back slowly, taking care that ailerons are in neutral position until the machine is well up in the air.

Take off at high speed is always best as the plane has attained a certain momentum that insures a safe landing if the power should fail suddenly. For the same reason, the take off should be at a good climbing angle; a machine should never be "zoomed" or made to jump into the air by a too rapid movement of the elevator flaps. If a machine is made to climb at an abrupt angle, the plane is apt to stall and sideslip to the ground. Zooming close to the ground is particularly dangerous if an engine is not developing full power or if it should fail suddenly. Stalling is a part of acrobatic flying and is not dangerous if carried on by a capable pilot at sufficient height from the ground. Remember that engine failure close to the ground always results in a crash if it occurs when taking off too slowly or at a sharp angle.

**How to Attain Altitude and Handle Machine.**—As soon as the plane is under way it should be driven in a straight line and at a gradual angle of climb until a safe altitude is reached, which should be between 800 and 1000 ft. It is stated that a high-speed low angle climb is much better than a slower large angle climb. The angle of climb, of course, depends on the



power available and resistance of the airplane parts. A high-powered machine of little resistance can climb at angles greatly in excess of those possible with the usual training type of airplane.

A height of at least 1000 ft. should be attained before a turn should be attempted by any but the most experienced pilots. A point to bear in mind at all times is the possibility of the airplane power-plant stopping, so the pilot must keep a safe landing place within gliding distance at all times. If one is climbing and it is desired to make a rather short turn, the machine is nosed over until it is flying level in order to keep the speed high. Simultaneously, the vertical rudder and ailerons are operated so the turn is made in the desired direction and banking proportional to the speed and radius of the turn. A turn of wide radius with a minimum of bank is better for the novice than turns of short radius which require steep banking. If a short turn is attempted and banking is not properly done, the machine may skid if the bank is not sufficient and sideslip if the bank is excessive and speed too slow. Either of these extremes is very dangerous, especially if it occurs close to the ground. A high angle of climb should be avoided on account of danger from stalling, which can only take place with safety at considerable distance from the ground. It is said that the modern airplane of good design has considerable inherent stability and it is better to be easy with the controls than to work them too quickly. Owing to the spread of an airplane immediate response to controls is not always obtained, a brief interval is required to have the plane answer. The slower and larger the airplane is, the more time is needed for controlling it. High speed, single-seater scouts are very responsive to controls, while bombing planes are not so manœverable. The controls should not be jerked, but should be firmly and smoothly handled. An expert pilot soon learns the feel of his ship and operates controls smoothly while the novice commonly overcontrols through sudden movements continued too long.

When a safe altitude is reached the pilot need have no anxiety if a landing field is within gliding distance. The

gliding possibilities of a machine depend on its design primarily; most machines have a gliding angle of 7 or 8 to 1, which means that the plane will glide a distance 7 to 8 times its vertical height. The direction of the wind has much to do with gliding distance and speed. Naturally, the possible distance of glide without power will be less when the machine is going against the wind than if it is with the wind.

When flying in a side wind it is necessary to fly at an angle in order to proceed in a straight line. This angle depends on the wind pressure and is necessary to effect the drift of the machine. Drift must also be considered in making turns. It is always best to nose down when turning in a cross wind in order to make sure one has the proper flying speed. While the air speed of a machine is always the same, the speed with relation to the ground changes with the wind velocity. A machine that would attain a speed of 70 miles per hour, relative to the ground in still air, will fly at 100 miles with a 30-mile wind back of it and move but 40 miles relative to some fixed point on the ground if its forward motion was opposed by the same wind.

**Precautions When Landing.**—In landing, certain precautions must be observed. When you feel you have approached your landing place sufficiently, shut off the engine, or better, throttle it down if there is any doubt about reaching the field on a normal glide. Always make a landing into the wind, as this will exert a braking action and bring the ship to a stop quicker. Never land in a cross wind if it can be avoided. If it is found that the ship is too close to the field to make a long, easy glide, a series of wide S turns can be made to reduce speed as well as altitude. Do not attempt to spiral into a field unless you are confident of your ability to execute the manœuvre properly. If the pilot has overshot the mark to any extent, it is better to make a wide circle and make another try at the field, starting your glide at the proper distance. The long, straight glide into the wind is the best way for anyone to make a landing, especially the novice, as it gives one a better chance to judge both wind and distance.

**Danger in Stalling.**—One of the most serious mistakes the

novice flyer is apt to make is gliding at too flat an angle, and the reason this is dangerous is that the loss of flying speed will result in the plane settling instead of gliding as it should. It should be remembered that unless flying speed is attained and maintained at all times, that the controls become inactive to considerable extent. The proportions of the ailerons and elevator flaps are based at a definite air resistance according to a speed which is but slightly less than the normal flying speed of the machine. It is necessary to have a pronounced air pressure on all controls if they are to be effective, and in order to have the airplane responsive to movements of the control planes, it is necessary to maintain flying speed either by use of the motor and propeller thrusts, or by a steep glide. In gliding, when the field is reached and the machine is 50 or 60 ft. from the ground, it is desirable to begin "levelling off," but the final "levelling off" should not be done until the machine has glided to a distance of approximately 6 or 7 ft. from the ground. The motor is shut off and at this point the airplane is moving forward, neither rising nor falling until its flying speed stops; thus it will sink to the ground gradually as the angle of attack of the wings is increased to bring the lift up to the point where it will carry the weight of the machine at a lessened speed. When the airplane is in the correct position for landing at its lowest flying speed, the tail skid and wheels of the machine should be just grazing the ground. Always pick as smooth and level a piece of ground as possible when making a landing, as, if the ground is very soft or if there are hummocks or ditches, the machine is very likely to "nose over." This, of course, will result in breakage of the propeller and impose considerable strain on parts of the airplane, even if it does not result more seriously.

**Control in Making Turns.**—The student aviator will perceive a pronounced tendency of an airplane to "nose down" when turning right hand and to climb when turning left hand. The last named condition is not as noticeable as the first named. This action is said to be due to the gyroscopic force of the propeller and must be met by the elevators to keep the

machine level. An important point to remember is that in banks of from 20 degrees the functions of the rudder and elevators really become rudders to direct the machine in a horizontal flight, while the vertical rudder, which normally directs its motion to the right or left, becomes an elevator to raise the machine up and down. The pilot must bear this in mind and when the machine is descending at a pronounced angle in action, all horizontal balance must be made by the vertical rudder and not by the elevators.

Perhaps the most common cause of airplane accidents, and one that is ever present when inexperienced pilots are handling the machine, is what is termed as "the tail spin" or "spinning nose dive." The tail spin is not dangerous to an experienced pilot if there is sufficient altitude to correct the machine's tendency to fall. In fact, in acrobatic flying, tail spins are very common and are used as a method of losing altitude. A tail spin is usually started by excessive banking with too much rudder, and the nose end of the machine falling, due to stalling or engine faults. Under these circumstances the ailerons and elevators are useless, for the air does not strike their under surface, but their edges. The best control method to counteract a tail spin is to set the control lever regulating on the ailerons and elevator in a vertical position and to put all possible rudder on in the direction opposite to that in which you are spinning, even though both feet must be used on one side of the rudder bar to exert the proper pressure. The rudder should be held in that position and the motor run on full throttle to supply all the possible air pressure. If there is sufficient altitude the machine will gradually straighten itself out and as soon as you realize that the rudder is functioning properly the same degree of control may be regained by using the elevators and ailerons in order to bring the machine to its proper flying position.

**Flying Learned Only by Practice.**—The point that must be borne in mind by all students of aviation is that it is not possible to learn to fly by reading a book, any more than it is to learn to swim or to ride a bicycle by the same method. A certain co-operation of the senses to produce the required sense

of balance is necessary and only practice under the tutelage of a competent pilot will enable the aviator to fly. There have been exceptional cases of when men have taught themselves to fly, as the early experiences of the Wright brothers and of Glen Curtiss demonstrated. At the same time, a number of pioneers who were their contemporaries gave up their lives in attempting to solve the same problems. The control of a machine in the air is not difficult as the pilot soon learns the necessary movements to have the plane recover its balance, or to nose up or down. The landings are the most difficult thing as in making functions it is only possible to make good ones by a combination of good judgment of distance and speed that comes naturally from considerable practice.

The following list of precautions are published by the Curtiss Aeroplane and Motor Corporation for the benefit of pilots using their machines, and as they are easily memorized and applied to all types they can be committed to memory by any prospective pilot to good advantage.

#### IMPORTANT HINTS

1. Remember that "A stitch in time saves nine."
2. Always inspect the motor thoroughly before starting.
3. Always have plenty of oil, water and gasoline before trying to start; all three are vital.
4. See that the radiator is *full* of water before starting.
5. Keep oil and gasoline clean, and free from water.
6. Oil all exposed working parts daily.
7. Be sure to retard magneto before starting; otherwise a serious accident may result.
8. Turn on switch before trying to start.
9. Start the motor with the throttle only part way open.
10. Run the motor idle for only short periods; it is wasteful and harmful to run idle too long.
11. Watch the lubrication constantly, it is most essential.
12. Remember that the propeller is the business end of the motor; treat it with profound respect when it is in motion.
13. When the motor is hot allow it to idle a few minutes at low speed before turning off the switch. This insures the

forced circulation of the cooling water until the cylinder walls have cooled considerably and also allows the valves to cool, preventing possible warping.

14. Avoid that destructive disease known as "tinkeritis"; when the motor is working satisfactorily, leave it alone.

15. Be sure to inspect daily all bolts and nuts. Keep them well tightened.

16. Stop the motor instantly upon detecting a knock, a grind, or other noise foreign to perfect operation. It may mean the difference between saving or ruining the motor.

## CHAPTER X

### UNCRATING, SETTING UP AND ALIGNING AIRPLANE

To Unpack Curtiss Biplane—How Parts are Packed—Examination of Parts before Assembly—Assembling Landing Gear to Fuselage—Panel Assembly—Main Panels Joined to Fuselage—Adjustment for Dihedral—Methods of Checking Dihedral—Checking Stagger—Wash-in and Wash-out—Tail Assembly—Landing Gear—Horizontal Stabilizer—Vertical Stabilizer—Elevators—Rudder—Aileron Adjustment—Rudder Control Adjustment—Elevator Control Adjustment—General—Checking Alignment of Wings and Fuselage—String and Straight Edge Method of Lining a Fuselage—Typical Airplanes in Practical Use.

WHILE it is possible to assemble an airplane by many methods and in various sequences, it will expedite and safeguard many possible errors to follow closely the chronological order established by such experience that has been gained by the several government schools during the past, and now adopted as the standard by most manufacturers. The Curtiss training biplane is taken as an example because it is a well-known pre-war type, and widely used in all parts of America and in Canada:

#### HOW TO UNPACK A CURTISS BIPLANE

1. Fuselage.—The fuselage of the JNs comes packed in special cases to prevent damage occurring while unpacking. To assure success the following instructions should be followed explicitly.

2. The packing case should always be kept on a flat surface to prevent warping the body of the machine. To prevent the necessity of turning the fuselage over and to prevent shifting of the motor, the case should always be kept with "Top" uppermost. The top may be easily recognized by its construction and by the mark.

3. In opening the case use a nail puller—never an axe or saw.

4. In taking off the top, draw out all the nails that are driven through the sides and ends. This will allow the top

to be taken off whole. Pull nails from, and remove cross braces to free propeller, which can then be lifted from case.

5. The next step is to remove the side marked "Front," and then the ends. All metal strips should be taken off first. The bottom and back side are left in place.

6. The fuselage should next be *lifted* out, which will leave the landing gear, wheels, etc., easily accessible.

7. The instructions for the fuselage should be followed in removing the panels. The side marked "Top" should be first removed, being careful to pull all the nails, then remove the nails from blocks that hold the cross pieces in place. When each set of cross pieces has been taken out the panels may be removed from the box.

#### HOW PARTS ARE PACKED

The major parts of the JN4 are packed in two cases, which may be designated by their contents as follows:

1. Fuselage.
2. Panels.

(1) The fuselage contains the motor set in place, with the instrument board and instruments all connected up; with the carburetor control and adjustment; throttle controls; with magneto cut-out switches all connected up and ready for operation, and with the tail skid in place. The control sticks are in their proper place. Around the seat-rails will be found the leads connected to the segment of the stick control for operating the ailerons, while the leads for controlling the elevators will be found attached to the control walking beams, with ends passed through the fairleads and coiled up in the fuselage back of the seat of the pilot. The rudder control wires are fastened to the foot control bar, and lead to the rear end of the fuselage cover, coiled up ready for leading through the fuselage for fastening to the rudder.

The landing gear, with cross stay wires connected up loosely, is completely assembled in this case. The landing gear wheels, propeller and exhaust equipment are also in this box.



(2) The panels with sockets and hinges all attached are in the panel box. The transverse and longitudinal wires are attached to the under side of the upper wing, coiled up and ready for attaching to the lower wing. The aileron control pulleys are in place on the under side of the upper wing; the aileron control cables have been passed through these pulleys and are coiled up with shackles and pin at one end for attaching to the control pylons of the aileron, and turnbuckles at the other end to be attached to the lead which comes from the stick control segment and through the side of the fuselage. This same panel case also contains the elevators and rudder with control pylons removed. This case contains all the control pylons for the ailerons, elevators and rudder. In this box also are contained the panel struts and engine section struts. The details of contents are given in the packing lists, marked "Panels."

When using a sling in lifting box containing the fuselage, care should be taken that the center of the lift comes somewhat ahead of the center of the box toward the motor end. This point can be quickly determined by trial, by lifting the bridle until the box rides level.

#### EXAMINATION OF PARTS BEFORE ASSEMBLY

With each fuselage box is sent a set of assembly drawings. These drawings should be studied carefully before commencing erection of machine. Each part should be identified by comparison with the erection prints as it is taken from the box. Each part which is packed separately from the unit of which it is a member has its identification number attached. All such units should be assembled before the machine proper is started on. If the instructions for unpacking are followed closely the danger of injury to members will be greatly lessened. The entire machine has been inspected and checked before shipment, but before setting up is attempted, go over the machine thoroughly and note the following:

##### A. FUSELAGE.

1. That no members are bent or damaged.

2. That the wires are in good condition. The fuselage trussing is shipped trued up, and hard wires should be taut. Safety wire on all turnbuckles on these wires should be intact.
3. No bolts on the trussing fittings should be loose or unlocked.
4. Be sure that the flexible cable leads are not kinked or the cable worked open. These leads will be found coiled up out of the way and should be left there till needed.
5. Make sure that no bolts or locking devices needed to erect the machine are missing. These bolts have been either put in place on the fitting to which they belong or will be found in a small bag in the front part of the fuselage case.
6. See that no exposed fittings necessary for alignment to other members are damaged or bent.
7. All motor and instrument connections should be tight and properly made.

**B. PANELS AND TAIL SURFACES.**

8. Surfaces must not be broken or torn.
9. Units should be comparatively tight and not easily warped or bent out of alignment. This part of the inspection is quite important, as these members are covered and cannot be readily inspected after erection is complete. If all members in the plane of the trussing are in alignment and not damaged, overstressed, or slackened, a considerable degree of rigidity may be expected.
10. All fittings on these surfaces should be tight and all bolts properly locked.
11. No flying, landing, or cross-bracing cables should be kinked, or the cable strands loosened.

**C. GENERAL.**

12. Check off on the packing sheets the remaining members necessary to complete the setting up. Make sure that all are present.

**Assembling Landing Gear to Fuselage.**—To assemble the landing gear, mount the wheels onto the axle and bolt in place, the fuselage is then elevated, either by tackle or by shims and blocking. If block and tackle are used, pass a line under the engine bed supports just to the rear of the radiator. To this line the hook of the block should be attached. Lifting device must not be attached to any other part, as there is danger of damaging or crushing. With the fuselage now resting on blocking, location of same being under the fuselage, at a vertical member of the fuselage side trussing, just ahead of the tail skid, lift the front end until the lower longeron clips for attachment of landing gear struts clear the landing gear. These clips may be easily found on inspection. The short bolts, with lock washers, nuts and cotters are found in the clips attached to the bottom longerons. With the lock washers under the heads of the bolts, and when the clips on the longerons line up with the clips on the ends of the landing gear, the bolts are passed down through the holes thus aligned. This facilitates assembling and inspection by placing the bolts on the down side. The castellated nuts are then put on the bolts and drawn tight until the drilled hole on the bolt is visible through the castle of the nut. The cotter pin is then inserted and the leaves spread back in two directions, which locks the nut in place. When the landing gear has been completely assembled to the fuselage, the tail of the machine should be elevated by a horse and blocking under the tail until the top longeron is level. Use a spirit level to determine this.

The other method that may be used in raising the front end of the fuselage to assemble the landing gear is as follows: Take out the blocking and front flooring of the shipping case from under the fore part of the fuselage. Insert a block under the bottom longerons at a point ahead of the point on which the fuselage is resting in the case. This block should be aligned under the vertical strut as shown in Fig. 99. The floor to the rear of the block may now be taken out. The nose of the machine is elevated by lowering the tail, using the above mentioned block as a fulcrum. The nose of the machine

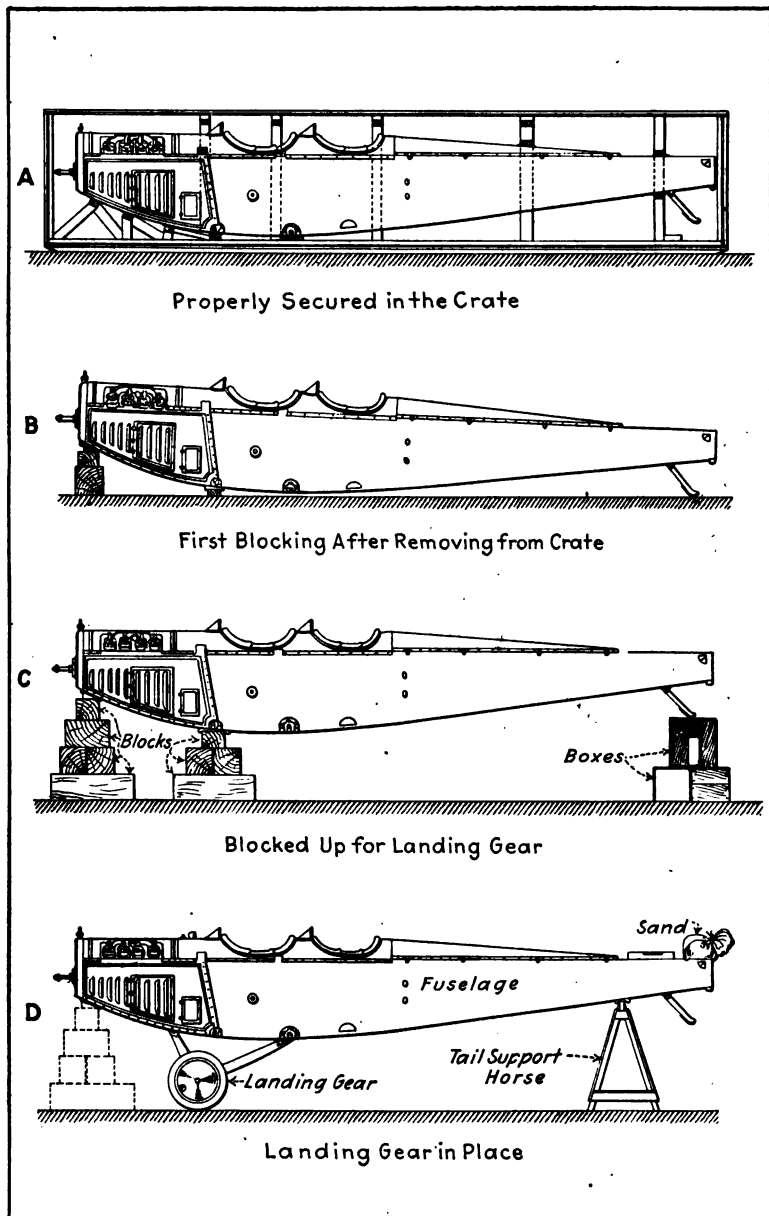


Fig. 99. Showing Steps in Uncrating Airplane Fuselage and Blocking It Up to Take Landing Gear. A. Fuselage in Crate. B. First Blocking. C. Blocked Up for Landing Gear. D. Landing Gear in Place, Blocks Removed.

should next be blocked up, being sure to place blocking under radiator bracket and not under radiator. Now lift the tail of the machine and this nose blocking will serve as a fulcrum and the fuselage at station 4 will clear the blocking at that point. Again block up under station 4 with wedges until block is tight against lower longeron. Again elevate the nose of the machine by depressing the tail. The nose blocking will now need to be increased. Thus, by alternately changing the fulcrum point and increasing the blocking, the nose will be



**Fig. 100.** Landing Gear Installed on Fuselage of Training Biplane.

finally raised to the point where the landing gear may be assembled to the fuselage. The appearance with landing gear installed is shown at Fig. 99 *D* and at Fig. 100.

**Panel Assembly.**—The engine, or center section panel, must be erected before the main panels can be connected to the fuselage. The center section struts are first placed in their sockets on the upper longerons. These posts will be found in the panel box. The forward posts are approximately held in place by the flexible wire lines, which will be found coiled up and fastened to the under side of the cowl in the motor compartment. The rear struts are approximately held in place by the flexible wire lines leading from the lower longeron

at station 7, and will be found tied to the control stick in the forward cockpit. The center section panel is now mounted on the struts after the front transverse bracing between the posts is trued up approximately. The engine section panel posts and wires may then be trued up before further erection. To obtain this condition all similar wires are adjusted to the same length.

**Main Panels.**—There are two methods of assembling the main panels to the machine. The panels, struts and wires may be assembled before attaching to the fuselage, or assemble the upper panel to the center section and then complete assembly. The first method is considered the better, as it permits of setting the main panels at the correct stagger and dihedral, requiring less subsequent adjustment than the other method.

**First Method.** All the main struts are marked with a number. The method used is as follows: Starting with post No. 1, which is the outer post on the left-hand side of the pilot as he faces the direction of travel, the front posts are numbered to No. 4, Nos. 1 and 2 being on the left side, and Nos. 3 and 4 being on the right. The rear posts are similarly numbered, from 5 to 8, Nos. 5 and 6 being on the left and Nos. 7 and 8 on the right. This does not include the center section struts. (See A, Fig. 101.)

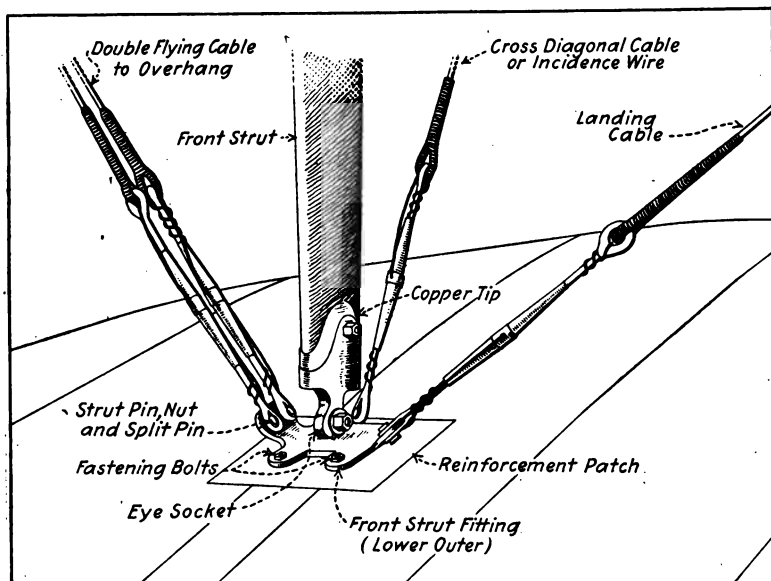
This system of marking also insures that the struts are not inverted. To accomplish this, all numbers on the struts have been painted so that they may be read from the pilot's seat. By this method an inverted strut can quickly be detected.

The upper left wing panel is first equipped with the front and rear masts by inserting the masts into their sockets on the upper surface of the panel. Then connect up the mast wires to the anchor plates, which will be found on the upper surface of the right and left mast-socket. Use the turnbuckles to adjust the tension of these wires, until the front and rear wing beams become straight in a vertical plane.

Stand the upper left wing panel and the lower left wing panel on their leading edges, properly supporting the panels in cushioned blocks to prevent damage to the nose. Space

the panels apart, approximately equal to the length of the struts.

Next the diagonal cross wires must be connected up. Connect these loosely to permit the easy entering of the posts into the sockets. The wires must be connected before the posts or struts are set in place, because if the latter are in place the connecting of the wires to the lugs of the sockets is



**Fig. 101. Lower End of Interplane Strut Showing Wing Fittings, and Turn-buckles and Clevises at Fitting End of Flying and Landing Wires.**

quite difficult. After these wires are thus inserted, insert the posts and bolts into place.

Connect up loosely the landing (single) wires and flying (double) wires of the outer bay to hold the wings together as a unit. The outer bay is thus completely wired, though but loosely.

The posts that are used for this left side are Nos. 1, 2, 5 and 6, according to the diagram. No. 1 is the outer front, No. 2 the inner front, No. 5 is the outer rear, and No. 6 the inner rear.

The wings may now be erected to the fuselage. Extreme care must be used to prevent straining or breaking them.

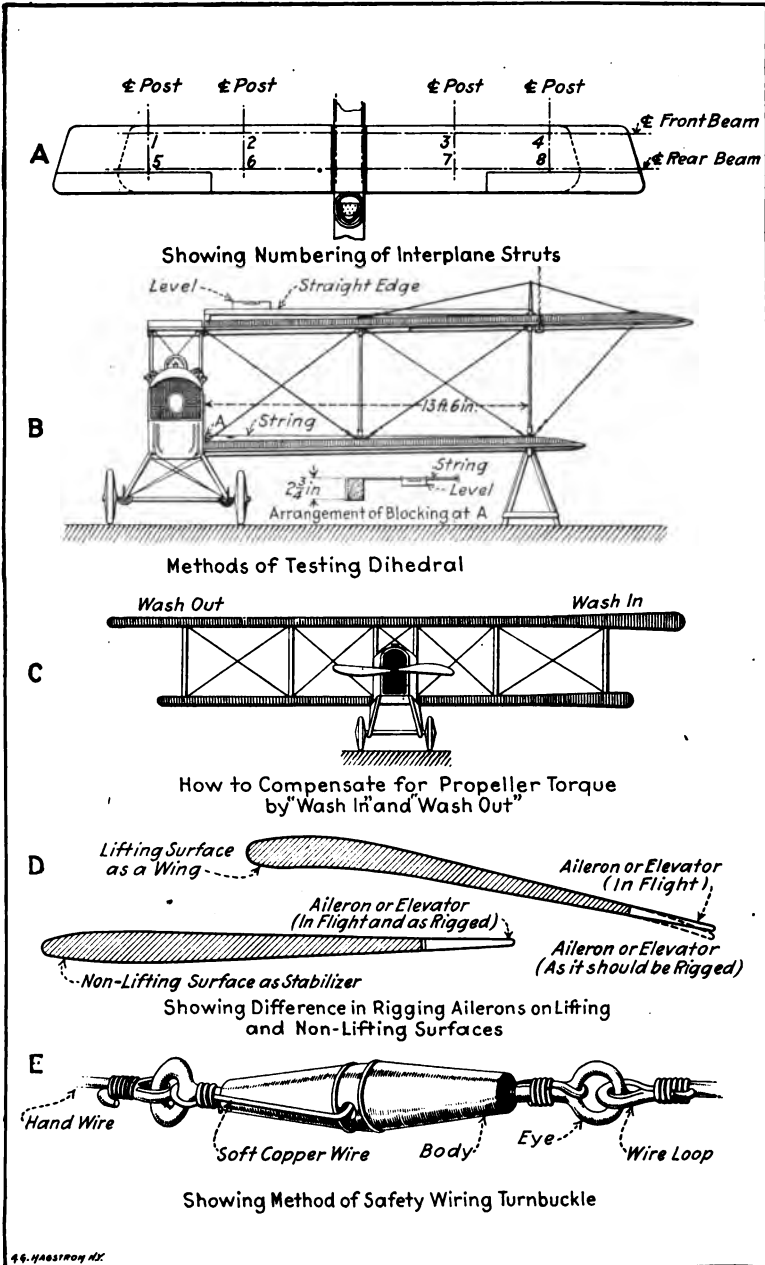


Fig. 102. Diagrams Illustrating Rigging Instructions.



In carrying, use boards under the wing beams so that these take the strain off the load. Handling the wings by using the posts as carriers or by attachments to the leading or trailing edges should not be attempted.

The wings must be firmly supported by slings or wooden horses. The wings will have the approximate stagger if assembled as above, as the posts are in place and the tension wires are adjusted to almost correct length when shipped. Insert the hinge pins through the hinges as now coupled up.

If an overhead crane or telpherage system is at hand, the carrier shown at Fig. 103 can be used as shown by the dotted installation. The lower (illustrated) condition is convenient for hand transportation. One carrier should be inserted under each panel point of the wings (next to the interplane posts), care being taken to use filler or spacer blocks under the main wing spars to carry the load and not take the weight on either wings or fabric as this will surely injure these parts.

**Adjustment for Dihedral.**—The fuselage must now be leveled up transversely and longitudinally. A spirit level placed across the top longerons will determine the transverse condition. With the level placed fore-and-aft on the longerons aft of station 5, the longitudinal level is established.

Adjust the tension on the flying and landing wires until the dihedral of one (1) degree is established, also to make the leading and trailing edges parallel and straight. The amount of lift for the one (1) degree dihedral is  $2\frac{3}{4}$  inches in 13 feet 6 inches (distance from the inner edge of the panel to the center line outer post). An easy method for checking the correct adjustment of the dihedral is to place a block  $2\frac{3}{4}$  inches high on the upper surface of the lower wing, at the extreme inner edge. A straight edge resting on this block and on the upper surface of the wing (straight edge kept parallel to front or rear beam) should be level, Fig. 102 B.

This may also be checked by using a light spirit level suspended from a string or copper wire stretched over the given range. If a block  $2\frac{3}{4}$  inches high be clamped to the inner edge of the panel, and a line pulled taut from this block to the center line of the outer beam, the level suspended next to

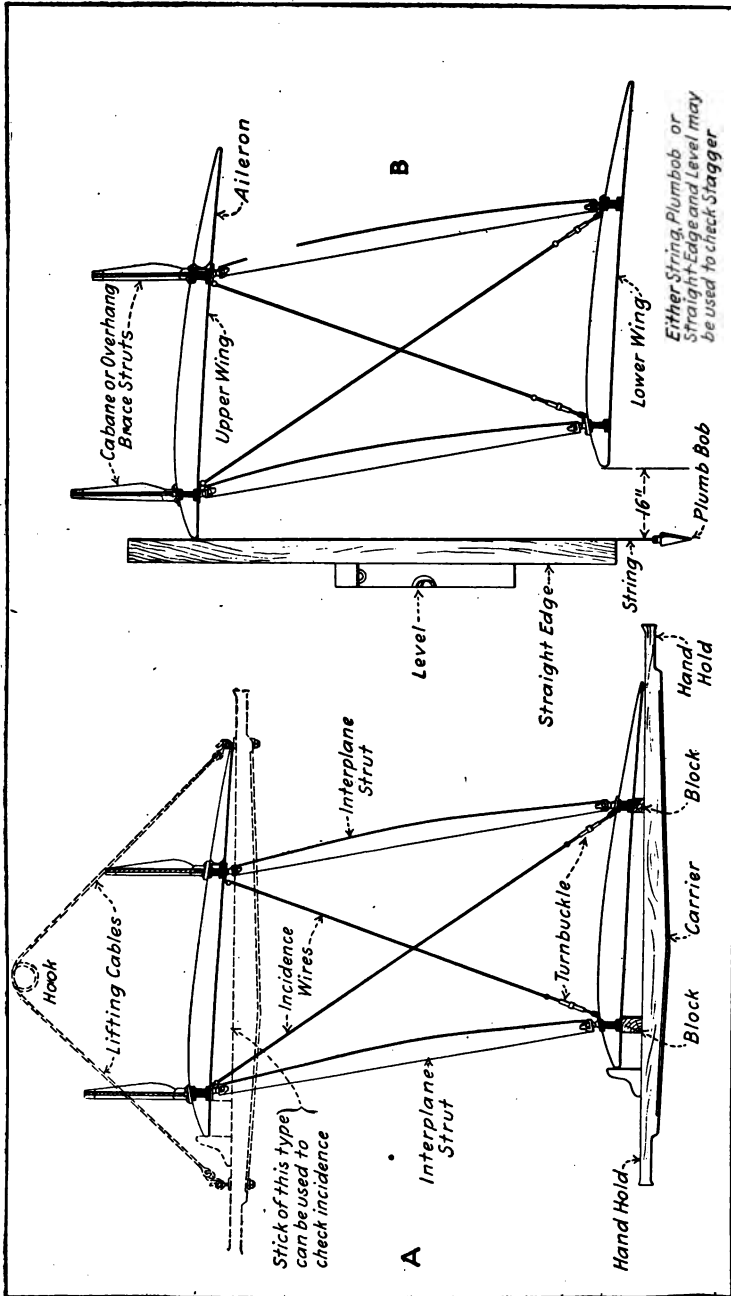


Fig. 103. Carrier for Panel Assembly at A and B. How to Test for Stagger.

the block will be sufficiently sensitive to determine the required degree of dihedral. Fig. 102 B shows the arrangement diagrammatically.

If the outer end of the wings is too high, the landing (single) wires are too short and the flying (double) wires are too long.

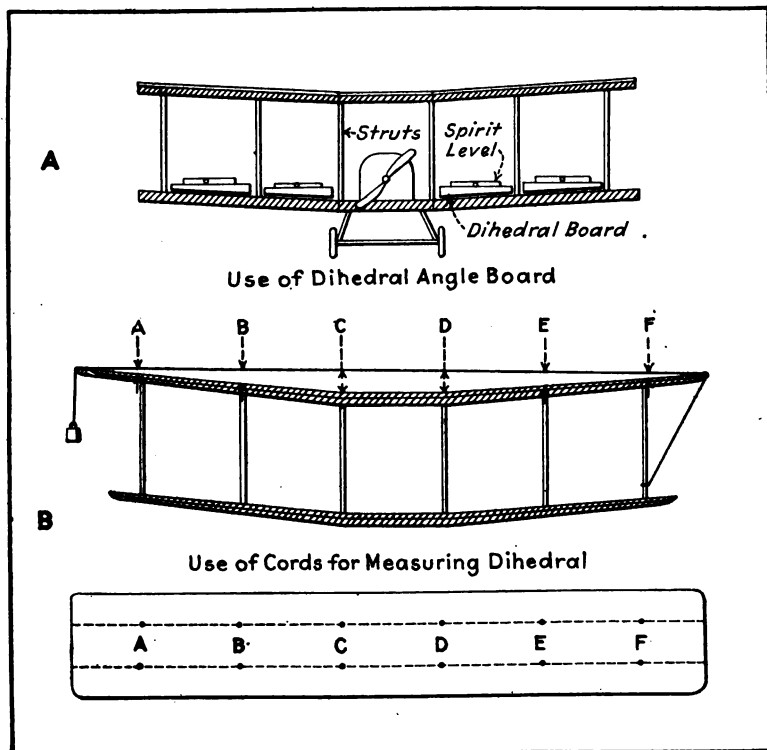


Fig. 104. Use of Dihedral Board Shown at A. Checking Dihedral by Measurements Shown at B.

Hence, loosening up equally on the inner and outer front and rear flying (double) wires will correct this condition. If the panels are too low (dihedral not up to one degree), reversing the above method corrects this condition.

**Three Methods of Checking Dihedral.**—During the adjustment for stagger and dihedral the rigging for supporting the panels must be maintained in place. Do not safety wire one side until the opposite side has been erected. The machine

will then be equally loaded on both sides. Go over the dihedral and stagger dimension to check up any possible change. When both sides agree with the specified values, safety wire all turnbuckles as shown at Fig. 102 E.

First Method. 1 inch vertically in every 57 inches horizontally equals one degree dihedral.

Second Method. Multiply the sine .0175 for every inch laterally equals one degree dihedral.

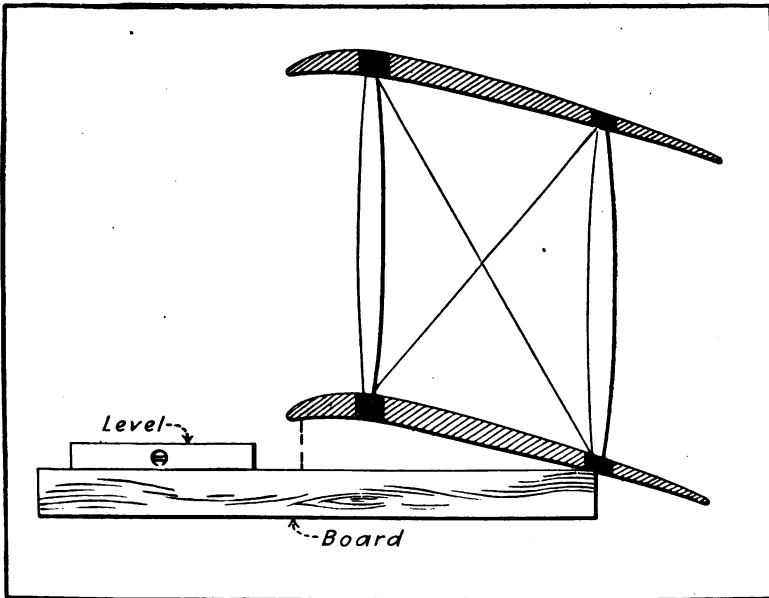


Fig. 105. How to Check Angle of Incidence of Wings. This is Determined on Most Planes by Location of Wing-Panel Support Fittings on Fuselage.

Third Method. Use straight edge and Starrett protractor as a dihedral board.

**Checking Stagger.**—First Method. The plumb line can be conveniently tied to the base of the wing mast on the upper panel. When checking the stagger at the inner end, the string may be attached to any of the upper panel upper surface fittings.

Second Method. A straight edge set vertically by plumb (level) is practical field method for checking up. Both of these methods are shown at Fig. 103 B.

**Wash-in and Wash-out.**—The turning of the propeller produces a tendency to turn the whole airplane around in the opposite direction to that in which the propeller is running. This tendency was very marked in some of the earlier machines, especially the small monoplanes. This is overcome in some machines by increasing the angle of incidence of the plane on the side which would tend to tip down and in some cases to decrease the angle of incidence on the other side. By so doing there is slightly more lift on one side of the machine than on the other, which corrects the tendency to turn around the center line of thrust. Two terms which are used in this connection are "wash-in" and "wash-out." When the angle of incidence increases from the center to the end of the plane it is called "wash-in," and when it decreases from the center to the ends it is called "wash-out." This is clearly shown at Fig. 102 C.

**Tail Assembly.**—The horizontal stabilizer, vertical stabilizer, rudder, and elevators are assembled to form the empennage. As shown at Fig. 106, the horizontal stabilizer is mounted at the rear end of the fuselage with its lower surface resting on the top edge of the upper longerons. A system of struts arranged from the under side of the stabilizer to the lower longerons and tail post anchors the stabilizer to the fuselage in a fore-and-aft direction. The vertical stabilizer is anchored on the upper center line of the horizontal stabilizer by suitable clips and tie-down cables.

The rudder is hung from the end edge of the vertical stabilizer and tail post of the fuselage. The guy lines from the control braces to the trailing edge are so fixed as not to interfere with the elevators during any position of operation. The upper edge of the rudder is in a continuous line with the leading edge of the vertical stabilizer. The elevators are arranged on the trailing edge of the horizontal stabilizer. The inner edges of the elevators are fixed so as to permit of operation of the rudder through an arc of at least 30 degrees each side of the fore-and-aft center line.

**Landing Gear.**—The landing gear is of the "V" type cross-braced construction. It is composed of two trusses, properly

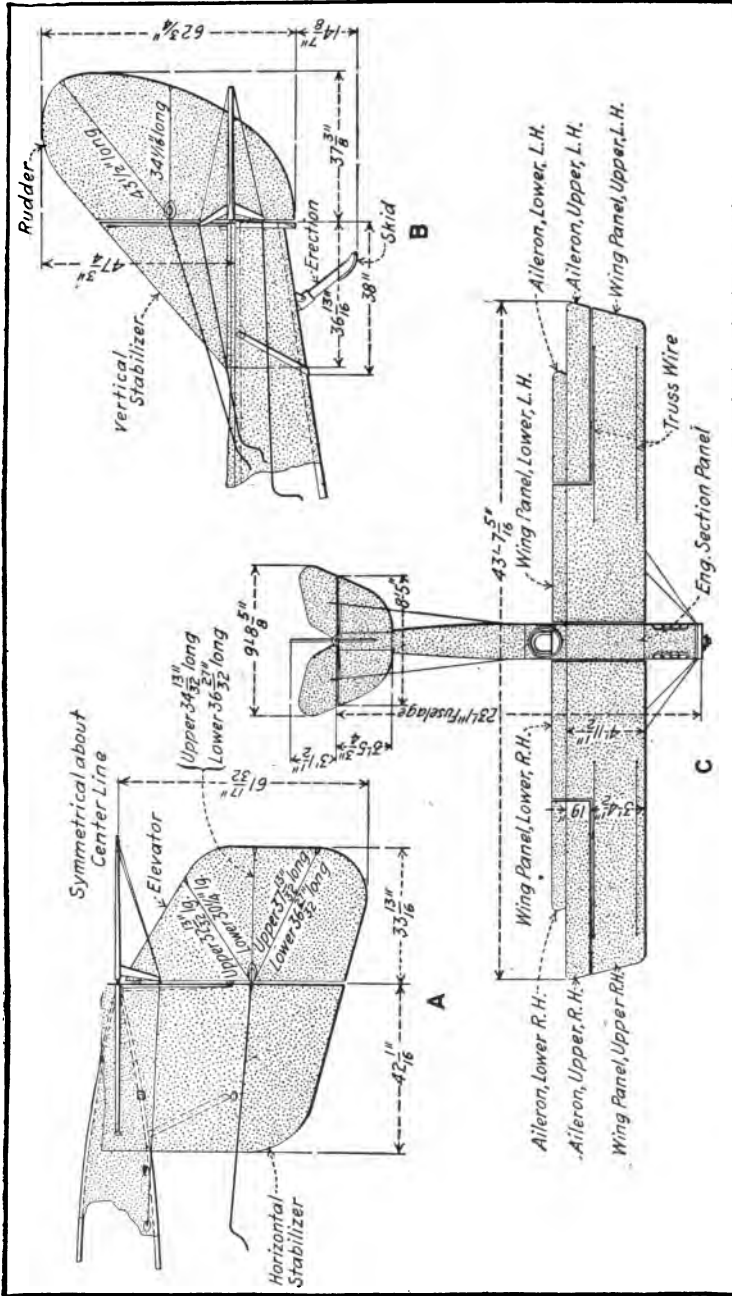
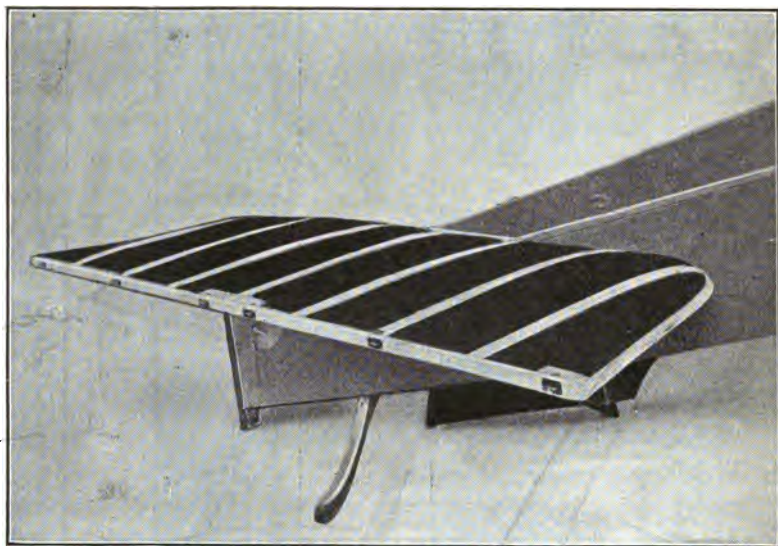


Fig. 106. Diagrams Showing Main Dimensions of Curtiss JN4 Training Biplane. A. Plan View of Assembly of Horizontal Stabilizer and Elevator. B. Assembly of Vertical Fin and Rudder. C. Plan View of Airplane with Wings and Empennage in Place on Fuselage.

separated and cross-braced. The lower ends of the members of each side truss end in the fittings of the continuous cord shock absorber bridge. The landing gear is connected to the lower longerons with proper fittings. The axle is properly streamlined. The bridge is so aligned vertically as to permit an upward and downward movement of the landing gear axle. The shock absorbing bridge is of the style known as the continuous rubber cord shock absorber.

The shock absorbing unit of the bridge is a continuous built-up rubber cord covered with fabric. This cord is firmly



**Fig. 107. Rear View of Fuselage with Horizontal Stabilizer Attached.**

wound around the axle saddle, which passes through the steel bridge and rests over the axle on both sides of the struts. The bridge itself is a lightened steel member with a slotted arrangement allowing the vertical movement of the axle. This guide for controlling the vertical movement is curved in a transverse direction to accommodate the vertical rotation of the axle about one wheel in case of a side landing.

**Horizontal Stabilizer.**—This member is assembled to the fuselage after the upper longeron is levelled up. Each upper longeron has one U bolt and one special bolt to fasten down the

horizontal stabilizer. This U bolt is just ahead of the tail and passes under the longeron with the legs pointing upward. These bolts extend through the stabilizer and are fastened with nuts. They serve to hold the leading edge of the stabilizer. Two special bolts are arranged at the tail of the machine so that they extend through the horizontal stabilizer, one on each side of the vertical stabilizer. These bolts also extend through a small L-shaped piece on each side, which is fastened to the vertical stabilizer. This fastens both stabilizers

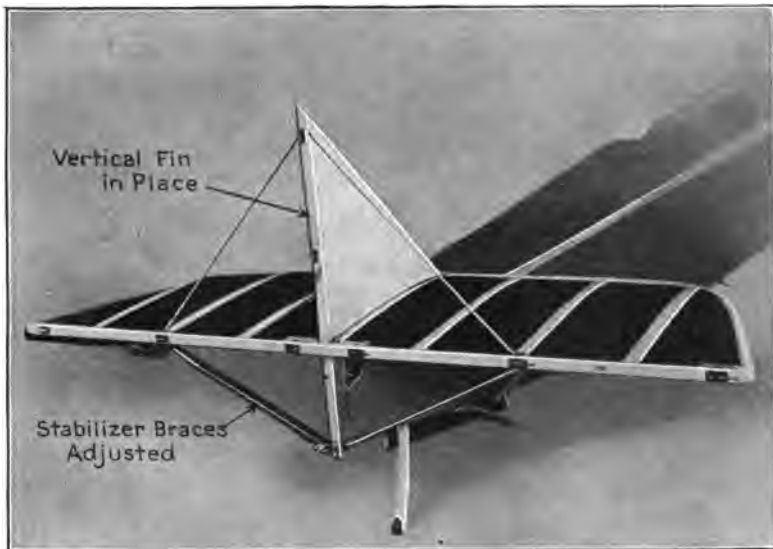


Fig. 108. Rear View of Fuselage Showing Vertical Fin Assembled and Stabilizer Braces in Place.

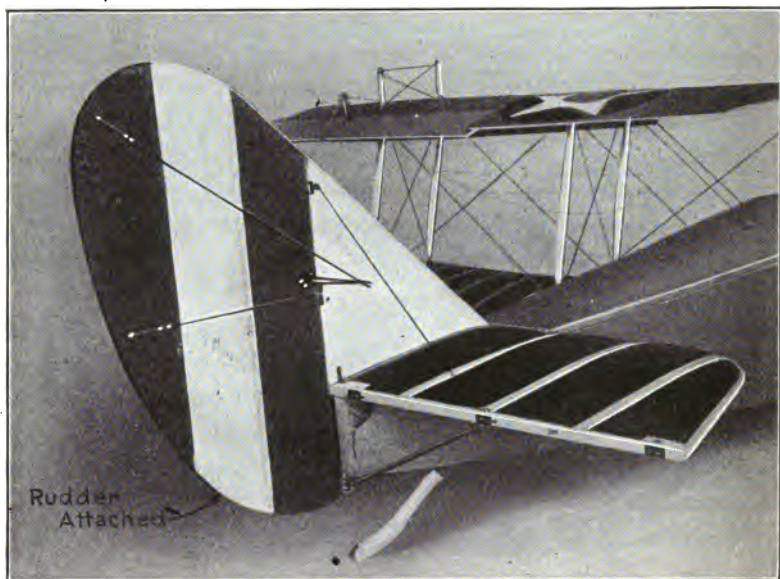
to the tail of the fuselage. These two bolts are flattened on their lower ends so that they rest against the tail post and are held to it by one bolt running through and by two screws, one on each side. All nuts are castellated and fastened with cotter pins. (See Fig. 107.)

**Vertical Stabilizer.**—Next, the vertical stabilizer is fastened to the horizontal stabilizer with the bolts which pass through the fore-and-aft parts of the horizontal stabilizer and with the hard wire stay lines running to the upper surface of the horizontal stabilizer from the top of the vertical stabilizer. The



forward bolts pass through the clip at the lower front point of the vertical stabilizer. The bolts which are fastened to the tail post of the fuselage, and engage the after end of the horizontal stabilizer, also engage the lugs fastened to the bottom edge of the vertical stabilizer at the rear. The nuts should be drawn up tight and locked with cotter pins. To align the vertical stabilizer hard wire lines and turnbuckles are used. (See Fig. 108.)

**Elevators.**—In assembling the elevators, first put on the control braces which will be found with all necessary bolts,



**Fig. 109. Rear View of Fuselage with Vertical Rudder in Place.**

nuts, and cotters in the case with the wing panels. The position of the base of the control brace is indicated on Fig. 123. The upper tips of these braces point to the hinge line. Hinges and hinge pins are used to mount the elevators to the horizontal stabilizer. Cotter pins are used to keep the hinges in place, and are inserted through the holes drilled in the bottom of the hinge pins. (See Fig. 110.)

**Rudder.**—The control pylons or braces are first attached to the rudder. They are so placed that the upper tips point to the hinge line, thus matching up the holes. The bolts and nuts for fastening braces to the rudder are shipped and fastened to the braces. Before mounting the rudder, see that the vertical stabilizer is in plumb alignment with the tail post. This alignment is absolutely necessary. The rudder may now be mounted onto the tail post and vertical stabilizer by means of hinges. The hinge pins are now inserted in the hinges and cotter pins put in the holes at the bottom of the pins and spread backward. (See Fig. 109.)

**Aileron Adjustment.**—Attach both ailerons (one on each side of machine, after having mounted control braces to ailerons) and fasten pins of hinges with the necessary cotter pins. Temporarily support ailerons so that their trailing edges are one inch below the trailing edges of the upper panels. Then connect up the flexible tie-line that, passing over the top of the upper wings through fairleads, is connected at the center by a turnbuckle and, passing through pulleys attached to the upper surface front beam, is attached (by shackle and pin) to the upper control brace of the aileron. This "lead" is allowed so that, when in flight, the force of the lift will somewhat raise *both* ailerons and bring their trailing edges on a line with the trailing edges of the panels. Now lead the end of the aileron control line attached to sector through the hole in each side of the fuselage (between front and rear seats). Uncoil the connecting line which passes over the pulley attached to the lower surface of the upper wing near the front outer post. Attach shackle and pin end to lower control brace of aileron, and attach turnbuckle end to loop of aileron control lead attached to control sector in fuselage (and which passes through side of fuselage). In making this last attachment, the leads should be so arranged (by moving the stick of the controls) that the lengths projecting through the fuselage are equal.

**Rudder Control Adjustment.**—Uncoil the lines attached to the rudder bar, to lead out through the upper surface of the rear end of the fuselage cover, and, keeping the rudder control

bar at right angles to the longitudinal axis of the machine, fasten the ends to the control braces. Next take up the slack of the lines by means of the turnbuckles, adjusting the tension equally in each set; the rudder control bar (foot control bar) should remain at right angles to the longitudinal axis when the rudder is neutral (or in a vertical plane through this fore-and-aft axis).

**Elevator Control Adjustment.**—Temporarily maintain the elevators in the plane of the horizontal stabilizer (neutra



Fig. 110. Rear View of Fuselage with Right-Hand Elevator Flap Installed.

position). Move the stick forward until the distance between the instrument board and the nearer surface of the tube of the stick is nine and one-half ( $9\frac{1}{2}$ ) inches. By fixing this distance from the instrument board or dash to the tube of the stick, a slight lead is given to the control for the greater range for raising the elevators. Now uncoil the wires leading from the clips attached to the walking beams of the stick control, and coiled up aft of the pilot's seat. Pass the wire attached to the lower end of the beam out through the side of the fuselage,

through the lower of the two vertical holes, aft of the pilot's seat. With the control stick lashed, or fastened, to the nine and one-half ( $9\frac{1}{2}$ ) inch position, connect this wire to the lower control brace of the elevator. Repeat operation for other side of machine.

Similarly the wire attached to upper end of the walking beam is passed through the upper hold in fuselage side, and attached to the upper control brace of the elevator. Photograph at Fig. 111 shows the general arrangement of the control wires at the rear of the fuselage. Adjust tension in these wires by means of

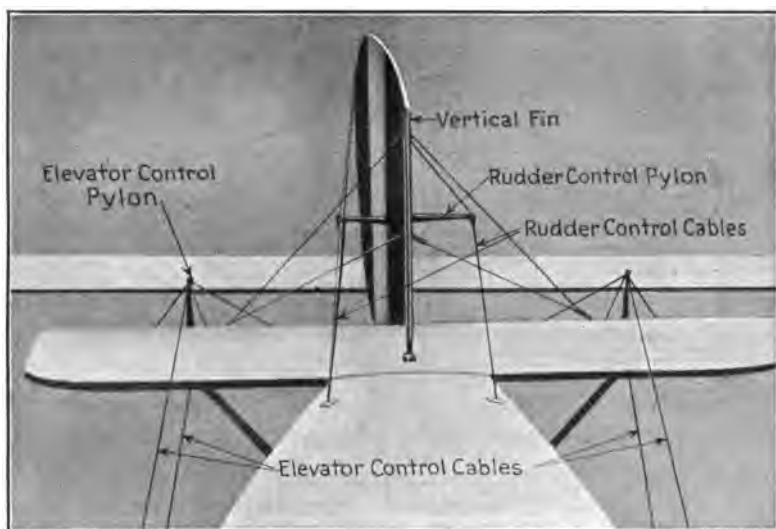


Fig. 111. View of Airplane Fuselage Rear with Elevator and Vertical Control Cables in Place.

turnbuckles, so that all lines have the same degree of tautness. The elevators will then be neutral for this position of the bridge.

**General.**—All connections having now been made, carefully go over each shackle, pin and turnbuckle, and see that all pins are properly in place, all nuts on bolts tight, and all cotter-pinned. Try out all controls for action and freedom of movement. See that no brace wires are slack, yet not so taut that, when plucked, they “sing.” Attach nose or drift wires leading from nose of machine to intermediate posts, front and rear.

The lower wire connects up with the lower front socket on the upper surface of the lower panel; the upper wire connects up with the upper rear socket plate on the under side of the upper panel, after the panels are attached to fuselage, with stagger and dihedral properly corrected.

#### CHECKING ALIGNMENT OF WINGS AND FUSELAGE

To align the cellule accurately with the fuselage, measure carefully from rudder post *A* to the rear outside bolts *B* of

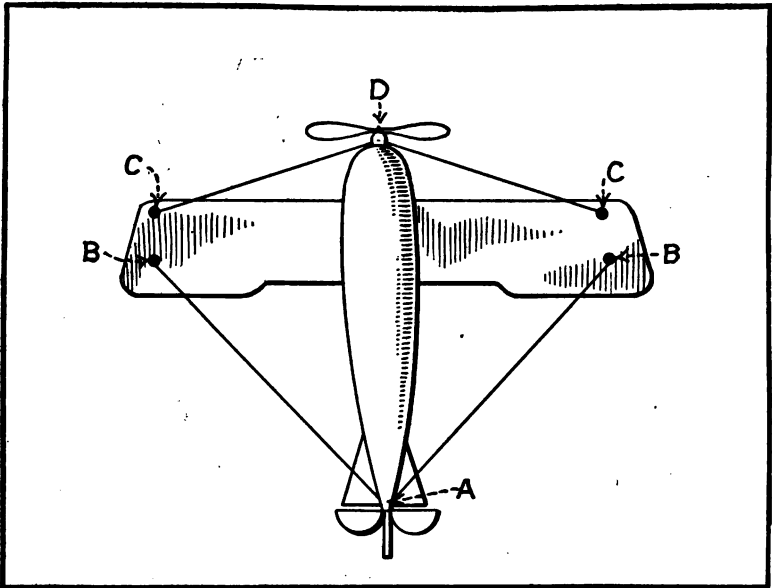


Fig. 112. Diagram Showing How Alignment of Wings and Fuselage is Verified.

outside strut fittings; from front bolts *C* of outside strut fittings to the propeller shaft *D*. If the parts are in correct alignment, distances *C-D* will be equal to each other and distances *A-B* will also [be the same on both sides of the machine. This method is clearly outlined at Fig. 112.

#### STRING AND STRAIGHT EDGE METHOD OF ALIGNING A FUSELAGE HAVING STRAIGHT TOP LONGERONS

1. True up the two front struts of the landing gear by diagonal measurement from corresponding points on the axle.

2. Square up the master struts with the top and bottom longerons by adjusting the interior cross wires. If there is any difference in the width of the top and bottom longerons, make it equal on each side. Also note that the engine beds are parallel by proper adjustment. When adjusting one set of side wires, always loosen the cross wires in section to be next adjusted.

3. Square the top longeron of No. 1 section on one side of fuselage with the center line of the master strut lengthwise. Raise or lower opposite front flying strut until longeron of same section is parallel with tops of master struts using the cross wires in the No. 1 section for this adjustment.

3a. To sight top longeron on one side parallel with the longeron on other side, place a white board about three feet long by 12 inches wide across top longeron, just forward of master strut fittings; place a black straight edge across longerons just back of master strut fittings with the white board for a background; place a white straight edge across top longerons just back of front flying strut fittings. Now sight from the rear of the tail post, raise or lower side to be adjusted until the top of the white straight edge coincides over its entire length with the top of the black straight edge.

4. Square up the side of the top longeron in No. 1 section lengthwise with the tops of the master strut fittings by adjusting the bottom cross wires in the No. 1 section. Then square up the sides of the front flying struts with the top longerons. This completes the No. 1 section.

5a. Now stretch a string from each side of the top longeron at the master strut fittings (held 1 inch from the side of the longeron by a stick  $28\frac{1}{2}$  inches long laid across fuselage) to the tail post (held same distance apart by a straight edge laid across center of last section).

5b. Place white straight edge in front of the rear flying strut fittings. Hold the string against the bottom of this white edge and raise or lower the rear flying strut until the string is flush with the top of longeron, at the front of flying strut, then sight straight edges until tops coincide. (If, when the straight edges sight parallel, the string does not check flush with the

longerons at the last adjusted strut, then the strut should be readjusted before proceeding further.) This makes the top longerons parallel in No. 2 section.

5c. Square the sides of the rear flying struts with the top longerons, equalizing the difference, if any, using the interior cross wires for this adjustment.

5d. Make the sides of the top longerons straight lengthwise by adjusting the bottom cross wires of No. 2 section until the string is the same distance from the longeron at the rear flying strut as at both the master strut and the front flying strut, and the No. 2 section is completed.

6. Now tighten carefully the rear cross wires of the landing gear until they are sufficiently taut and the same tension.

7. Repeat 5a, b, c, d, in No. 3 section, but check string flush with tops of longerons at rear flying struts instead of front flying struts.

8a. In section No. 4 make longerons parallel and straight as before and then square up the sides.

8b. With side strings equal distance from each master strut and No. 1 strut, tie another string on the center of the No. 1 top cross strut and the center of the string spreader (straight edge) at tail. As the longerons taper inward from the No. 1 strut to the tail post the above string is used to get the fuselage straight by checking with the center lines on top cross struts.

9. After getting No. 2 top cross strut central, center string may be loosened from the tail fastening and the remaining cross struts may be made central by holding the string on the center mark of each strut and adjusting to the right or left until string coincides with center mark on No. 2 top cross strut.

10. To get the longeron straight at the tail post, place three cubes (each  $1\frac{1}{2}$  inches square) on top longeron at last three sections, and adjust tail post until tops of all three cubes are flush with the straight edge placed on them.

11. The tail post should be square with the sides of the fuselage and to make it so, place a large square across the tops of the top longerons at the stabilizer section, letting one side of it hang parallel with the fuselage; and with a straight edge against the upper and lower rudder hinge fittings sight across





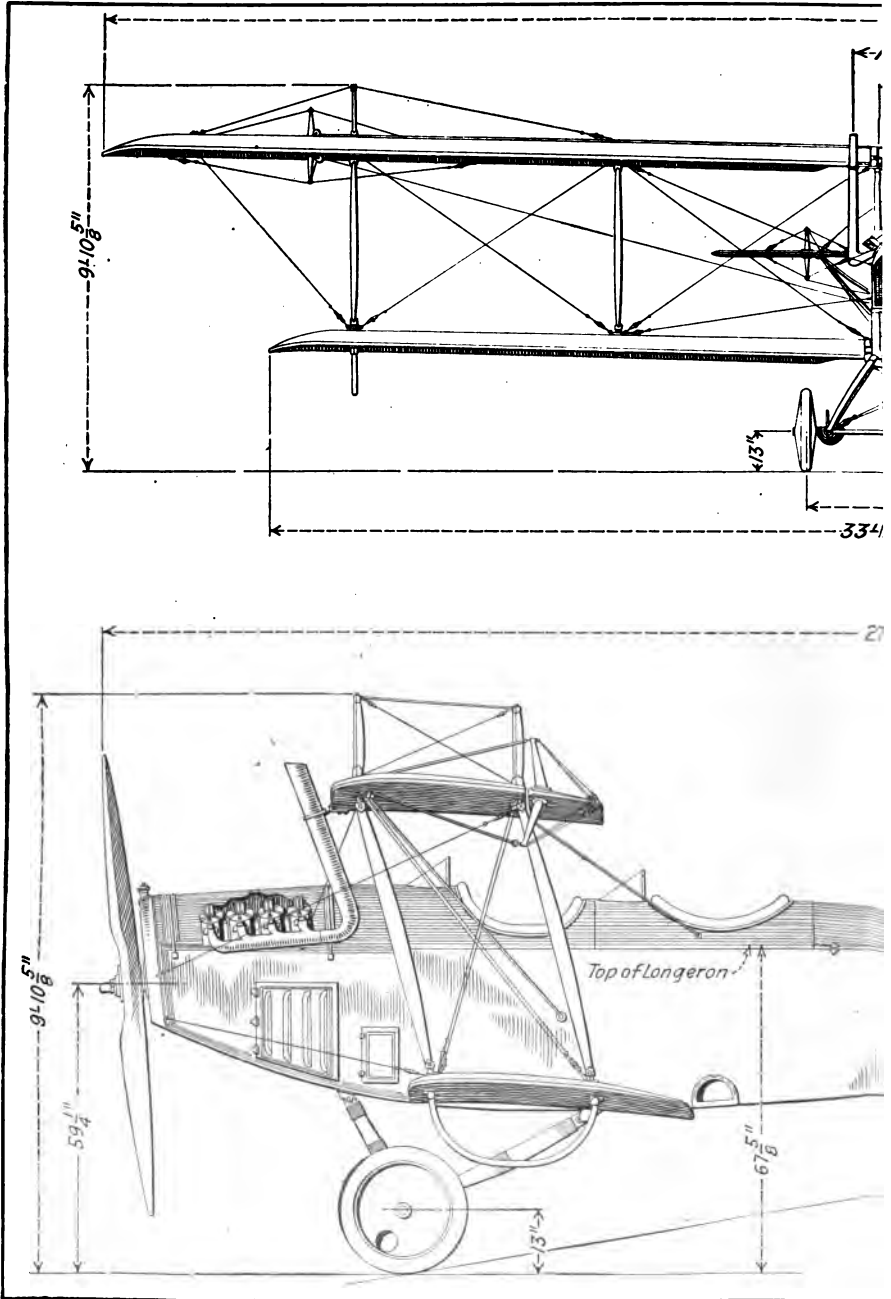
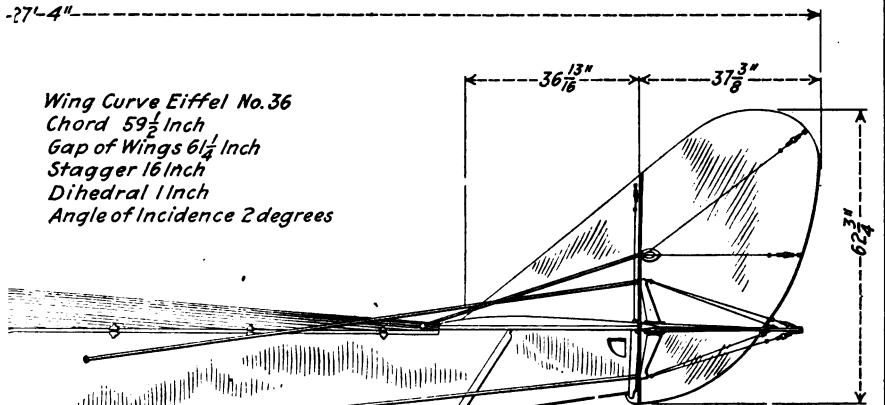
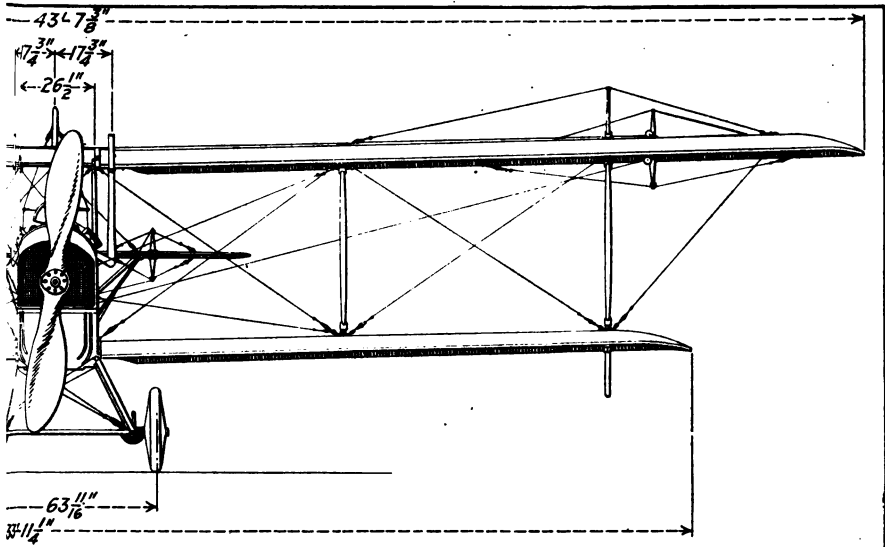
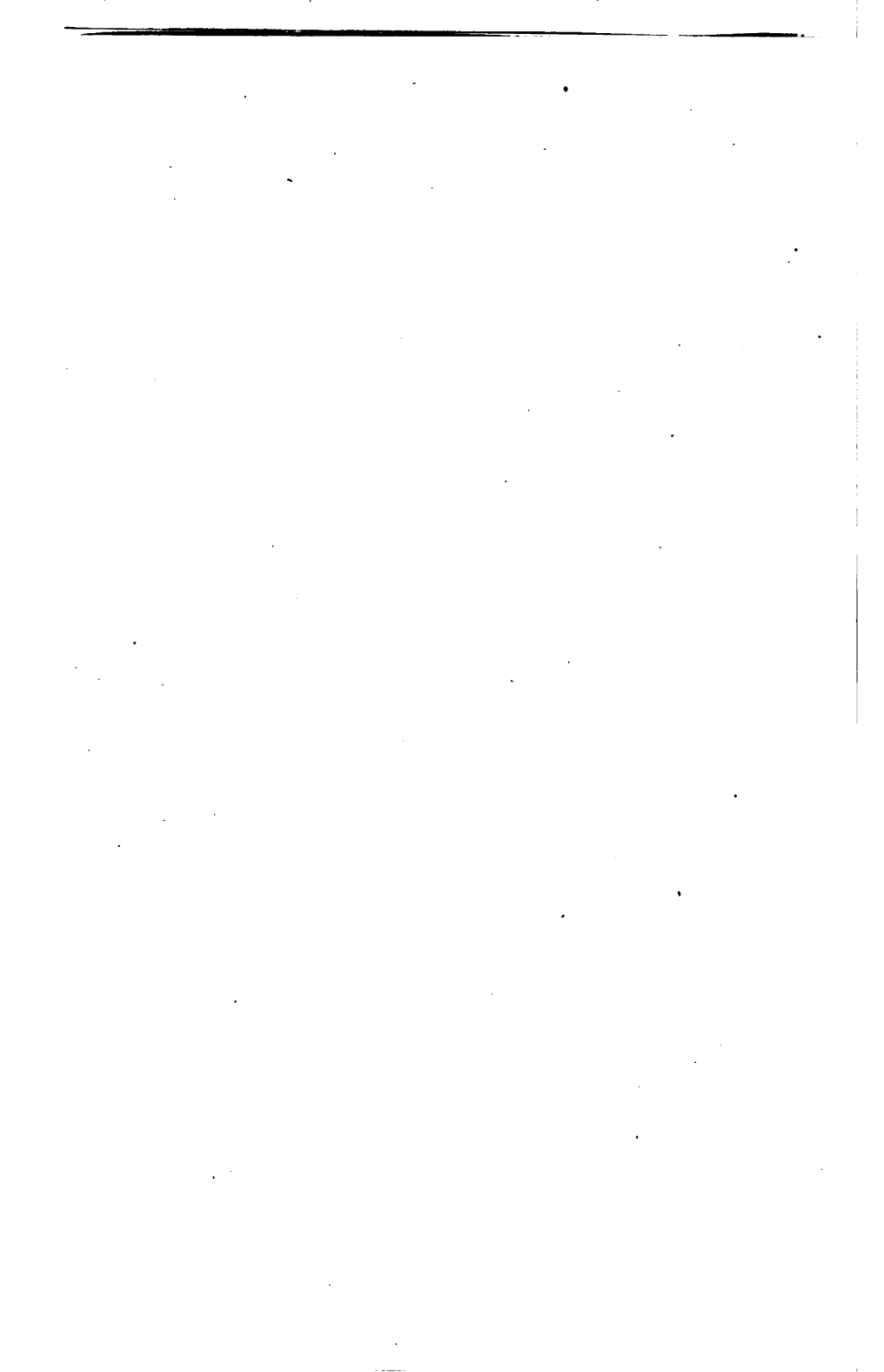


Fig. 113. Diagrams Showing Dimensions of Widely Used Curtiss J. N.



**N. 4 Training Biplane, a Popular Pre-War Design of Great Reliability.**



or along the edge of the straight edge and the hanging side of the square, adjusting wires in the last section until the tail post comes square.

12a. Engine bed and engine section. The rear ends of the engine bed pieces are parallel with the top longerons by their construction and the entire length of the engine bed pieces is made to coincide with the rear ends by adjusting the side cross wires of the engine section. First ascertain which side of the engine bed is high, then place a straight edge on top of the top longerons over strut forward of the master strut. If the same side shows high, then adjust by the cross wires in the section next to the master strut. But if the longerons are parallel, crosswise at this point, then raise the nose by adjusting the cross wires in the nose section until the front end of the engine bed pieces are parallel crosswise with the rear end.

12b. Raise or lower both sides of the entire engine section until engine bed pieces are parallel lengthwise with the tops of the longerons.

12c. Fasten strings at a set distance from the side of lower longerons at the rear flying struts to the side of the lower longerons at the nose of the fuselage. Now adjust the nose of the fuselage to the right or left until the string is the same set distance from the side of the master struts. This should align the fuselage practically accurate.

Fuselage alignment is very important as much depends upon its accuracy. If the rear end is not true and level, the flying qualities will be impaired because the empennage will be twisted instead of in its correct plane. Any lack of alignment will be indicated by erratic flight. Just as it takes a straight, true arrow to hit its mark, so it takes a well aligned fuselage to insure true flight and ready control.

#### TYPICAL AIRPLANES IN PRACTICAL USE

The Curtiss JN4 Airplane was a pre-war development and has been generally described in the aviation prints, so its construction and detail features are so well known that the censorship regulations that apply to airplanes of recent development designed for military purposes do not prevent a brief

review of the main dimensions and features of this thoroughly tried, safe and practical airship, which is reproduced from the instruction book of the makers. This airplane is clearly shown at Fig. 113 and is an excellent example of conservative yet absolutely modern airplane design.

**GENERAL DIMENSIONS:**

Wing span—upper plane . . . . .	43 ft., 7 $\frac{3}{8}$ in.
Wing span—lower plane . . . . .	33 ft., 11 $\frac{1}{4}$ in.
Depth of chord . . . . .	59 $\frac{1}{2}$ in.
Gap between planes . . . . .	60 in.
Stagger . . . . .	16 in.
Length of machine, over all . . . . .	27 ft., 4 in.
Height of machine, over all . . . . .	9 ft., 10 $\frac{5}{8}$ in.
Normal angle of incidence of panels . . . . .	2 degrees
Dihedral angle . . . . .	1 degree
Sweep back . . . . .	0 degree
Angle of incidence of horizontal stabilizer . . . . .	0 degree

**AREAS:**

Upper planes* . . . . .	167.94 sq. ft.
Lower planes* . . . . .	149.42 sq. ft.
Ailerons (each 17.6 sq. ft.)* . . . . .	35.20 sq. ft.
Horizontal stabilizer . . . . .	28.70 sq. ft.
Vertical stabilizer . . . . .	3.80 sq. ft.
Elevators (each 11.00 sq. ft.) . . . . .	22.00 sq. ft.
Rudder . . . . .	12.00 sq. ft.

**WEIGHT:**

Net weight, machine empty . . . . .	1430 lbs.
Gross weight, machine loaded . . . . .	1920 lbs.
Useful load . . . . .	490 lbs.
Fuel (21 U. S. Gals.) . . . . .	130.0 lbs.
Oil . . . . .	30.0 lbs.
Pilot . . . . .	165.0 lbs.
Passenger . . . . .	165.0 lbs.
Total . . . . .	490.0 lbs.
Loading per sq. ft. supporting surface . . . . .	5.45 lbs.
Loading per R. H. P . . . . .	21.35 lbs.

**PERFORMANCE:**

Speed, maximum, horizontal flight . . . . .	75 miles per hr.
Speed, minimum, horizontal flight . . . . .	45 miles per hr.
Climb in 10 minutes . . . . .	2000 ft.

**MOTOR:**

Model OX-5, "V," four-stroke cycle, 8-cylinder, water-cooled.	
Horse-power (rated at 1400 R.P.M.) . . . . .	90
Weight per R. H. P. . . . .	4.33 lbs.
Bore and stroke . . . . .	4 in. x 5 in.

\* Total supporting surface, 352.56 sq. ft.



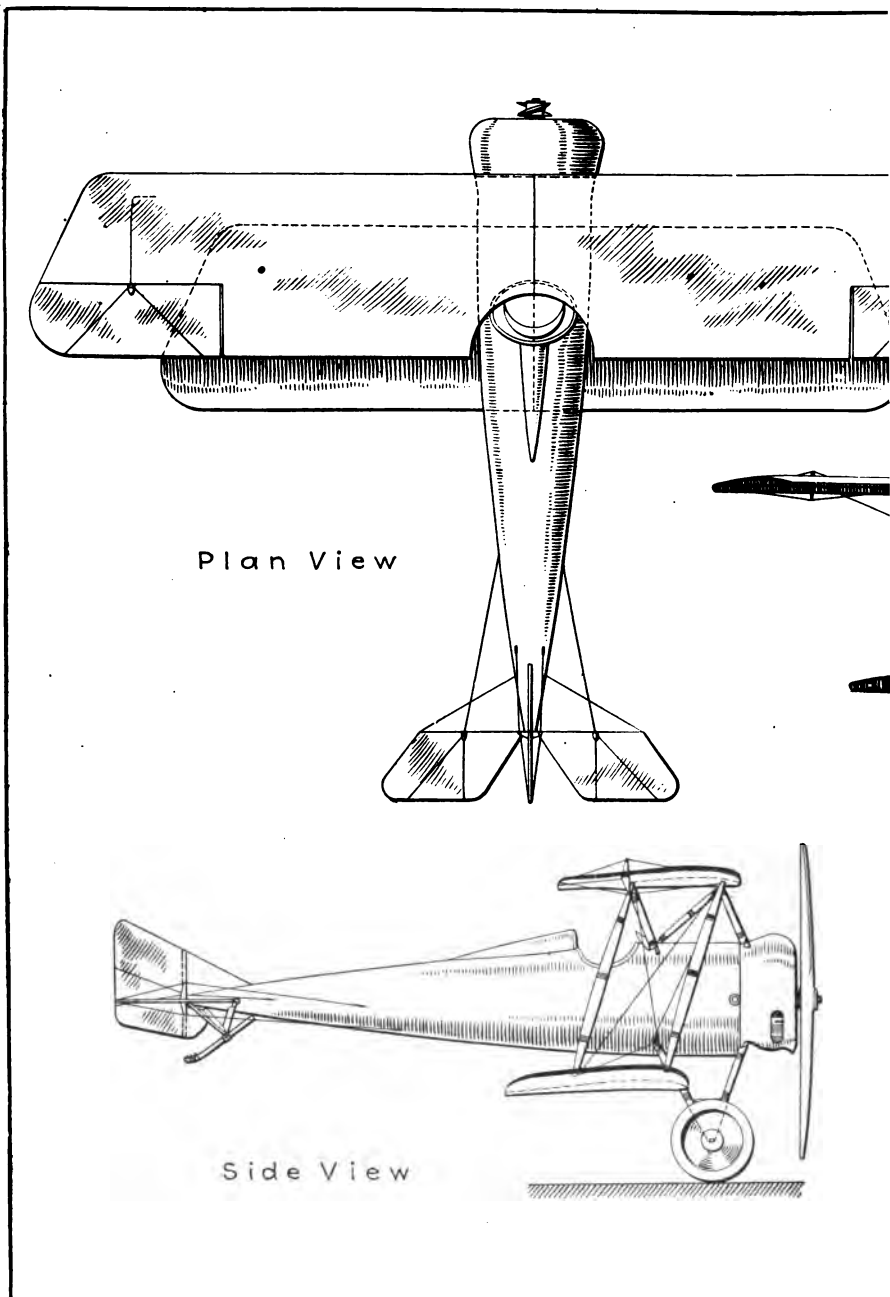
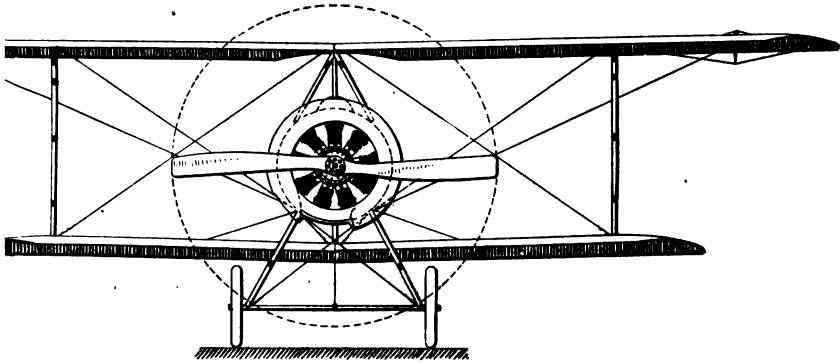
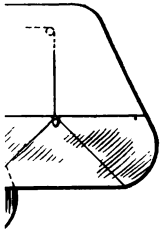


Fig. 114. Design Drawings of Berkman Speed Scout, a Single-Seat, High Speed



Front View

**General Specifications**

<i>Span, upper plane</i>	26'-0"
<i>Span, lower plane</i>	19'-0"
<i>Chord, both planes</i>	4'-11"
<i>Gap</i>	5'-3"
<i>Stagger</i>	17°
<i>Length of machine overall</i>	18'-0"
<i>Height of machine overall</i>	8'-9"
<i>Net Weight-machine empty</i>	820 lb.
<i>Gross Weight-machine and load</i>	1,190 lb.
<i>Useful load</i>	370 lb.
<i>Engine, G.V.Gnome</i>	100 H.P.
<i>Speed range</i>	115-54 mph.
<i>Climbing speed</i>	1,100 ft. per min.
<i>Gliding angle</i>	8 to 1
<i>Radius of action</i>	2½ hrs.

**Biplane of Recent Development that Shows Latest Features of Airplane Design.**





**The Sopwith Triplane.**—The following description of one of the first Sopwith fighting triplanes appeared in the German aviation magazine "Flugsport" and as its main characteristics are so well known to the German aeronautical engineers, there can be no objection to the present publication on the part of the censors. The illustrations at Fig. 115 show the main details very clearly.

The body with tail plane and rudder is the same as that of the small Sopwith single-seater biplanes. The three wings have a span of 8.07 m. and a chord of 1 m. The lower and middle wings are attached to short wing sections on the body, while the upper plane fits to a center section supported by struts from the body.

Both spars of the upper wing are left solid, while those of the lower and middle wings are of I-section. The interplane struts, which are of spruce and of streamline section, run from the upper to the lower wing, and the inner ones from the upper wing to the bottom longeron of the body. In order to give a better view, the middle wing, which is on a level with the pilot's eyes, is cut away near the body.

The wing bracing is in the form of streamline wires of  $\frac{1}{4}$  in. diameter. The very simply arranged landing wires are in the plane of the struts, while the bracing of the body struts, as well as the duplicate lift wires, are taken further forward.

These further particulars are worthy of note: fuel capacity for two hours, gasoline 85 liters, oil 23 liters; area of wings and flaps (square meters), upper 7.90, middle 6.96, lower 7.10, total 21.96; area of elevators 6 by .5, of wing flaps, 1.10, of rudder .41. Angle of incidence (degrees): upper wing, root + 1, tip - .8; middle, root + 1.5, tip + 1.5; lower, root + .5, tip - .5; tail plane, variable + 2 to - 2 degrees. Loading per square meter, empty 22.3, fully loaded 31.4; loading per brake H.P., empty 4.15, fully loaded 5.85.

From the rear spar of the middle wing wires are run forward and rearward to the upper longeron of the body, and the lower wing also has a wire running forward to the lower longeron of the body. All the planes have wing flaps, and inspection windows of celluloid are fitted over the pulleys for the wing flap cables.

The engine is a 110 H.P. Clerget rotary, and the gasoline is led to the engine by means of a small propeller air pump mounted on the right-hand body strut. The net weight of

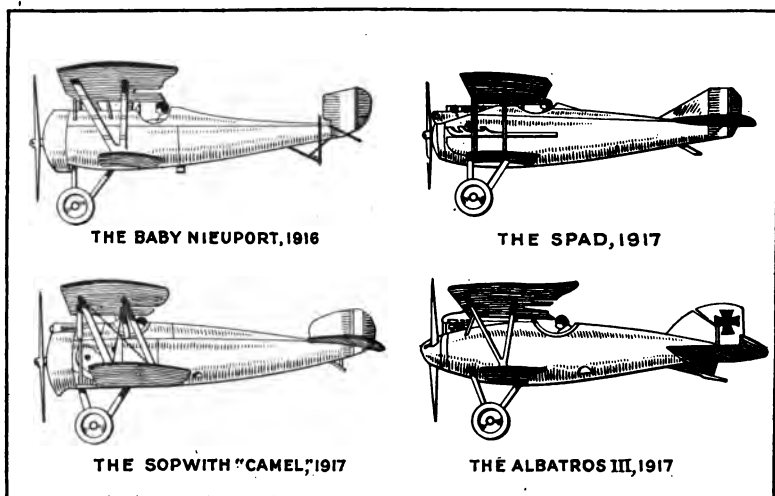


Fig. 116. Typical Single-Seat Fighting Scouts of French, English, and German Design that Have Been Built in Large Quantities.

the machine was found to be 490 kg. and if the useful load is assumed to be 200 kg., we obtain a gross weight of 690 kg. This with an area of 21.96 sq. m. would give a lift loading of 31.4 kg. per sq. m.

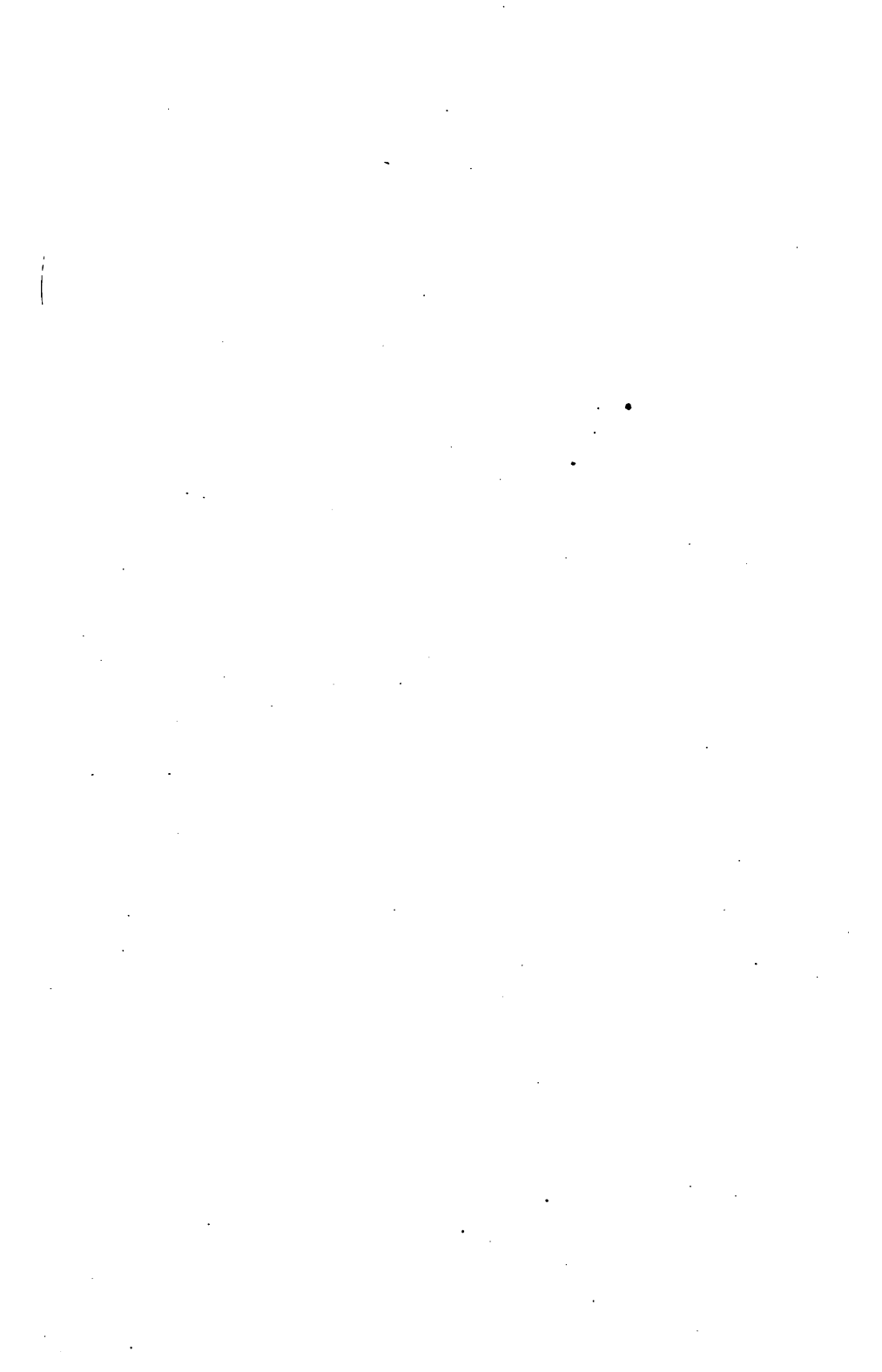
#### WEIGHTS

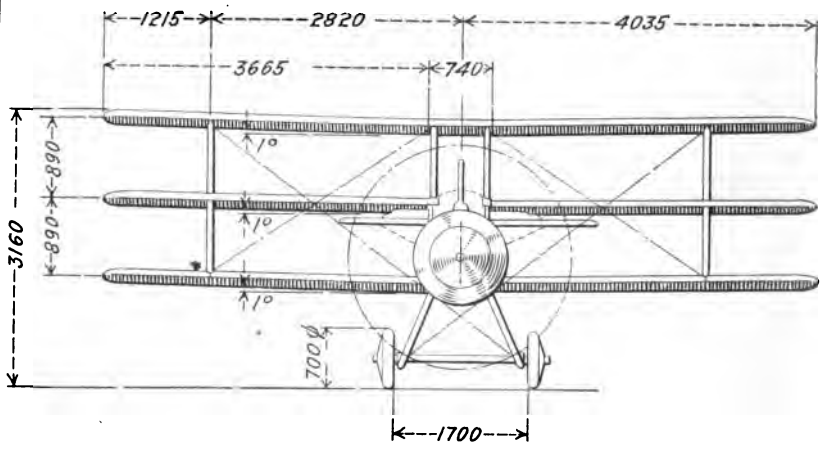
	kg.
Body with under-carriage and accessories . . . . .	123.5
Wings . . . . .	135
Tail plane, rudder and elevator . . . . .	13
Engine . . . . .	160
Gasoline tank . . . . .	15
Oil tank . . . . .	8.5
Air screw . . . . .	16
Engine accessories . . . . .	16
Mounting . . . . .	3

	490
Pilot . . . . .	80
Gun and ammunition . . . . .	40
35 litres of petrol and 23 litres of oil . . . . .	80

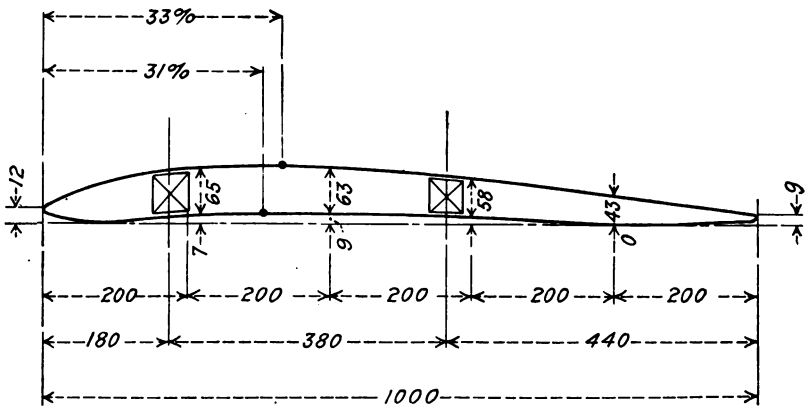
---

200



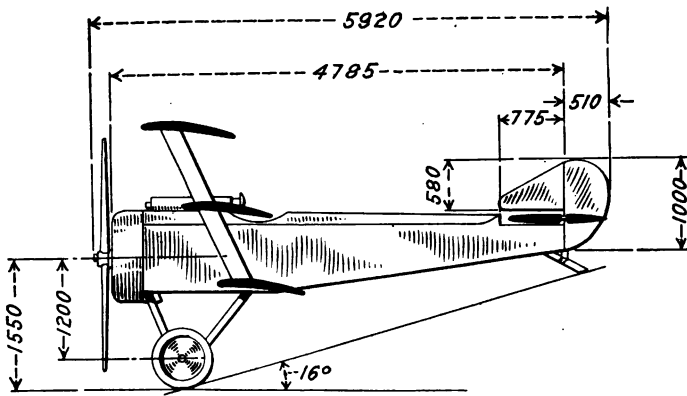


Front Elevation

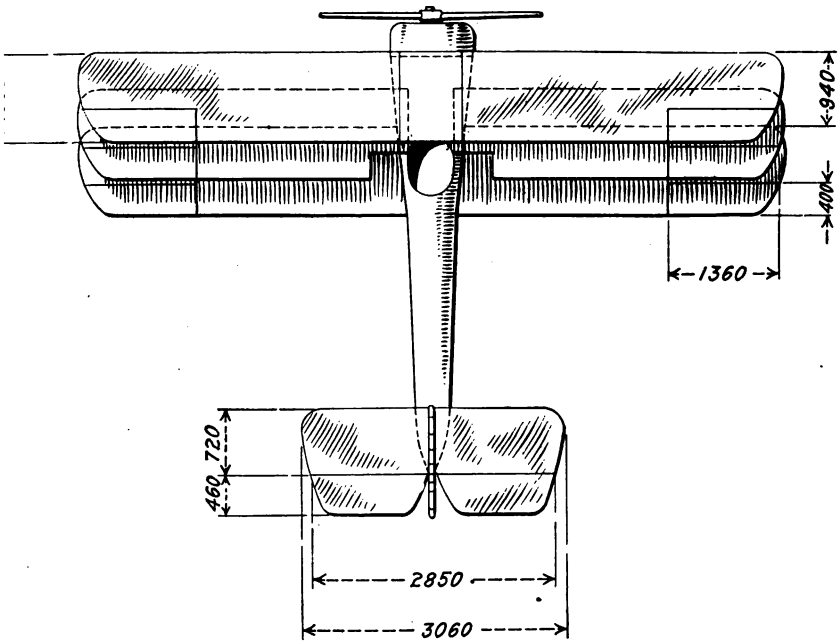


Wing Section of the Sopwith Triplane

Fig. 115.. Drawings Showing Construction of Sopwith

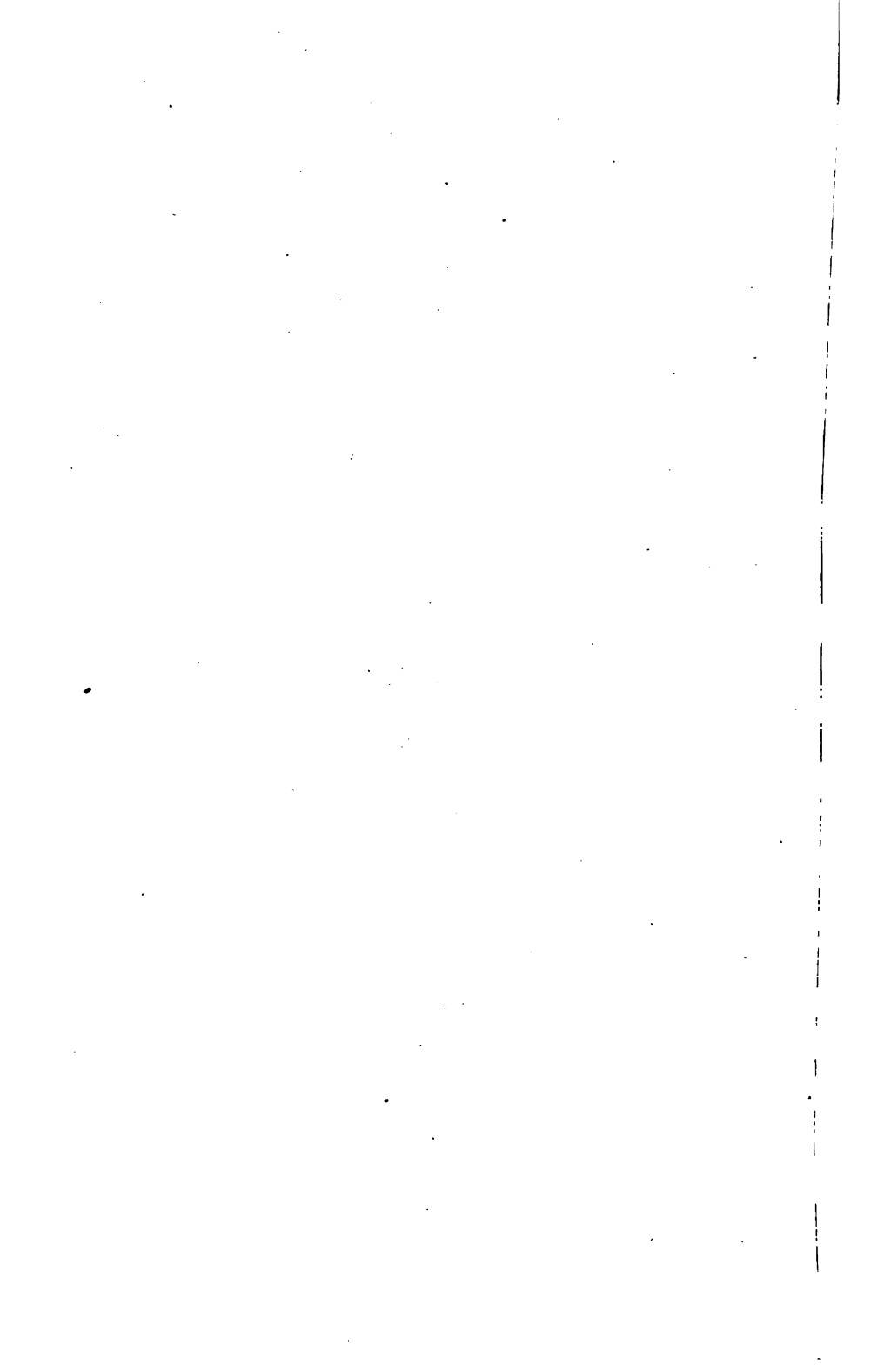


Side Elevation



Plan View

iplane, a Single-Seat Fighting Scout of Unusual Design.



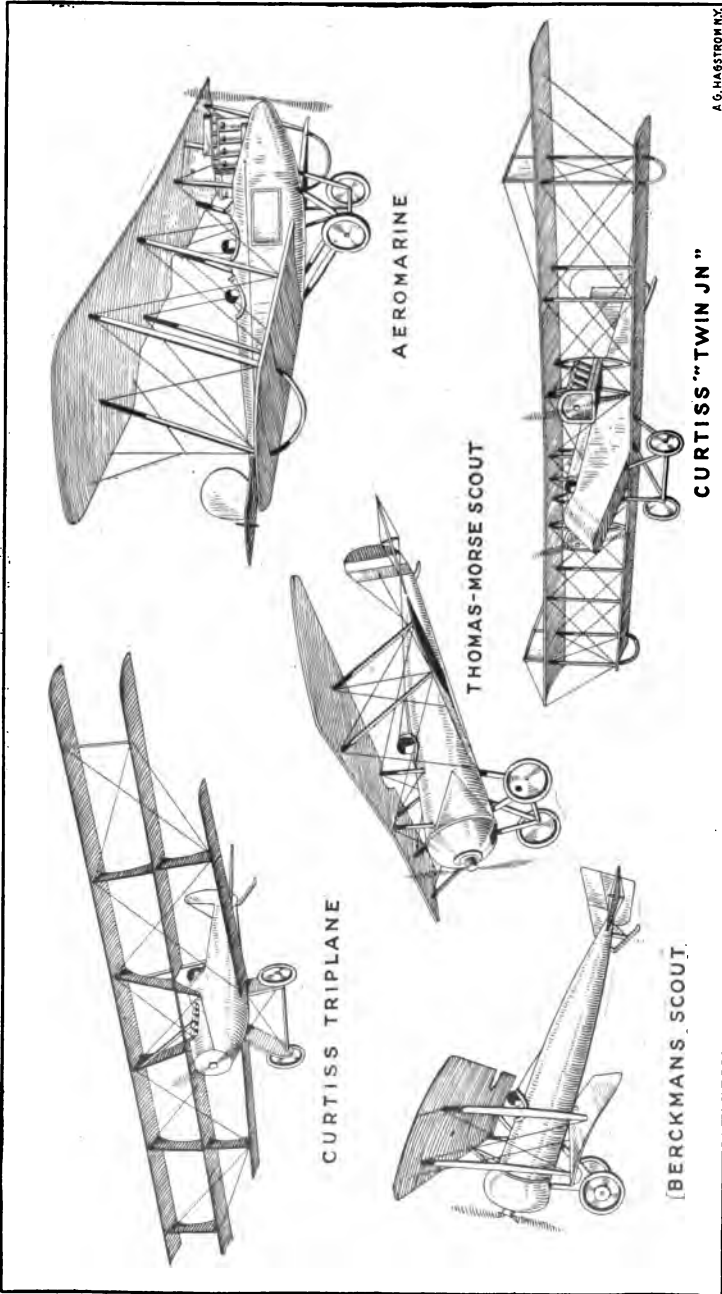
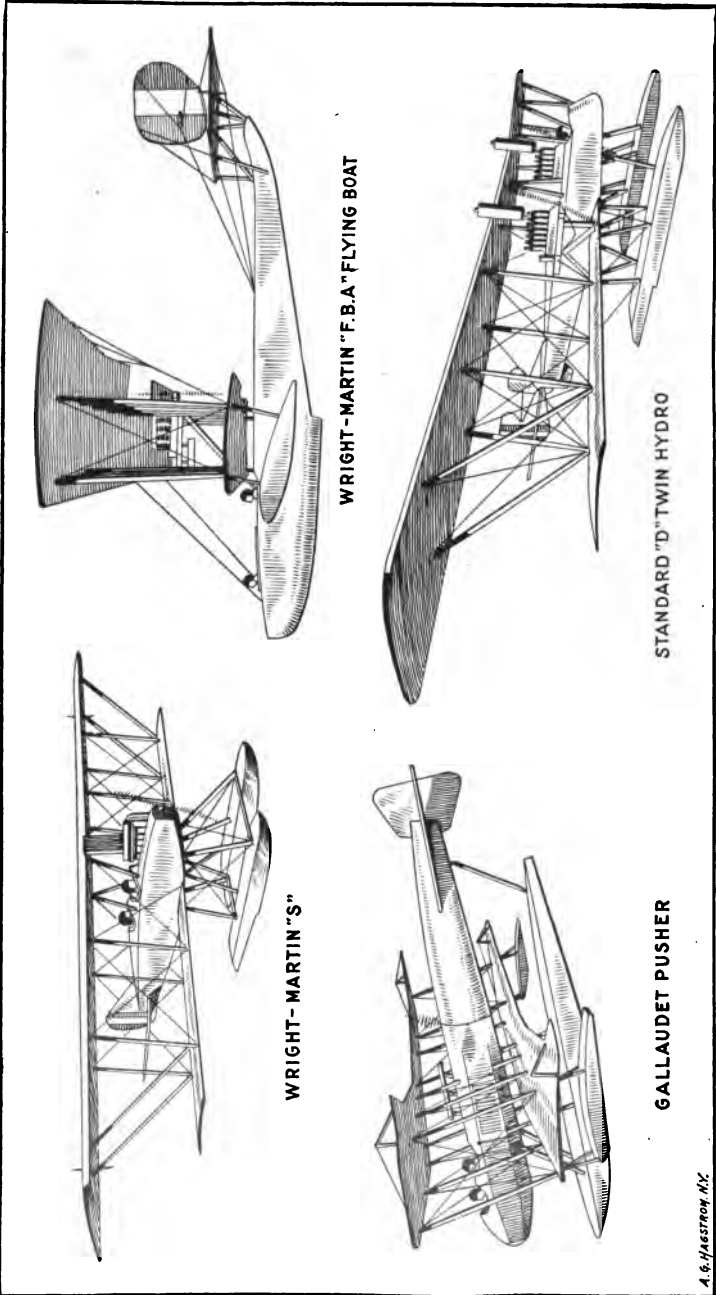


Plate 3. Practical American Airplanes of Varying Design and Power Showing Appearance in Flight.





WRIGHT-MARTIN "S"

WRIGHT-MARTIN "F.B.A." FLYING BOAT

GALLAUDET PUSHER

STANDARD "D" TWIN HYDRO

A. G. HASTROP, N.Y.

Plate 4. Pre-War Designs of American Seaplanes and Flying Boats That Have Made Practical Flights

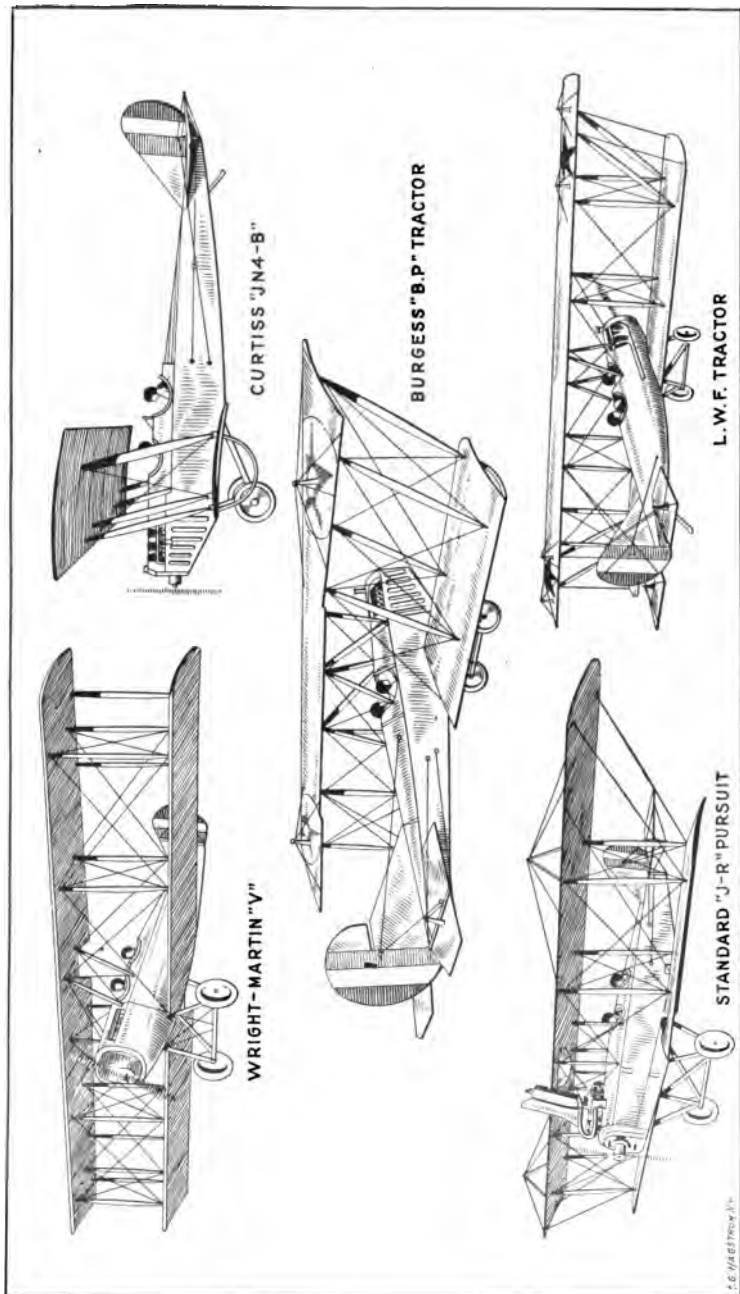
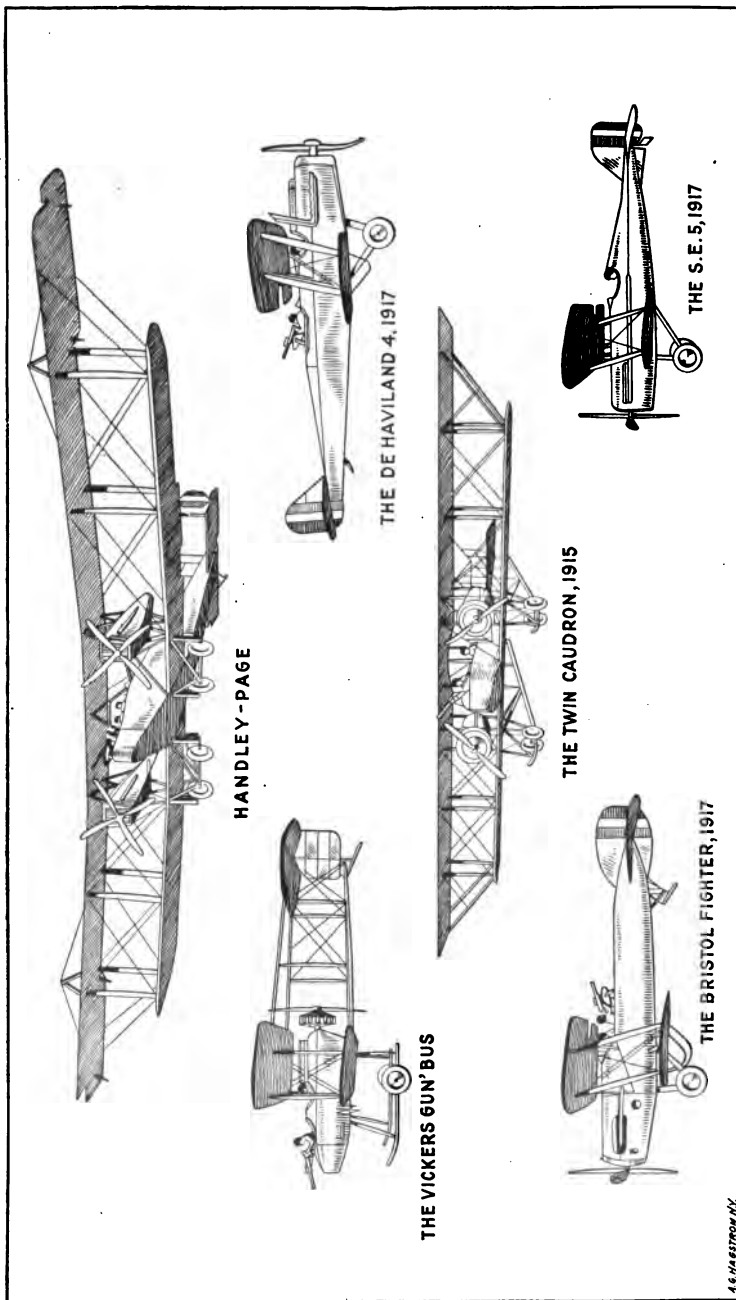


Plate 5. Drawings Showing Typical Airplanes Developed before the War That Were Suitable for Practical Cross-Country Flights.



44-1122000-117

Plate 6. Foreign Airplane Designs that Incorporate Modern Aeronautic Practice to a High Degree of Refinement.

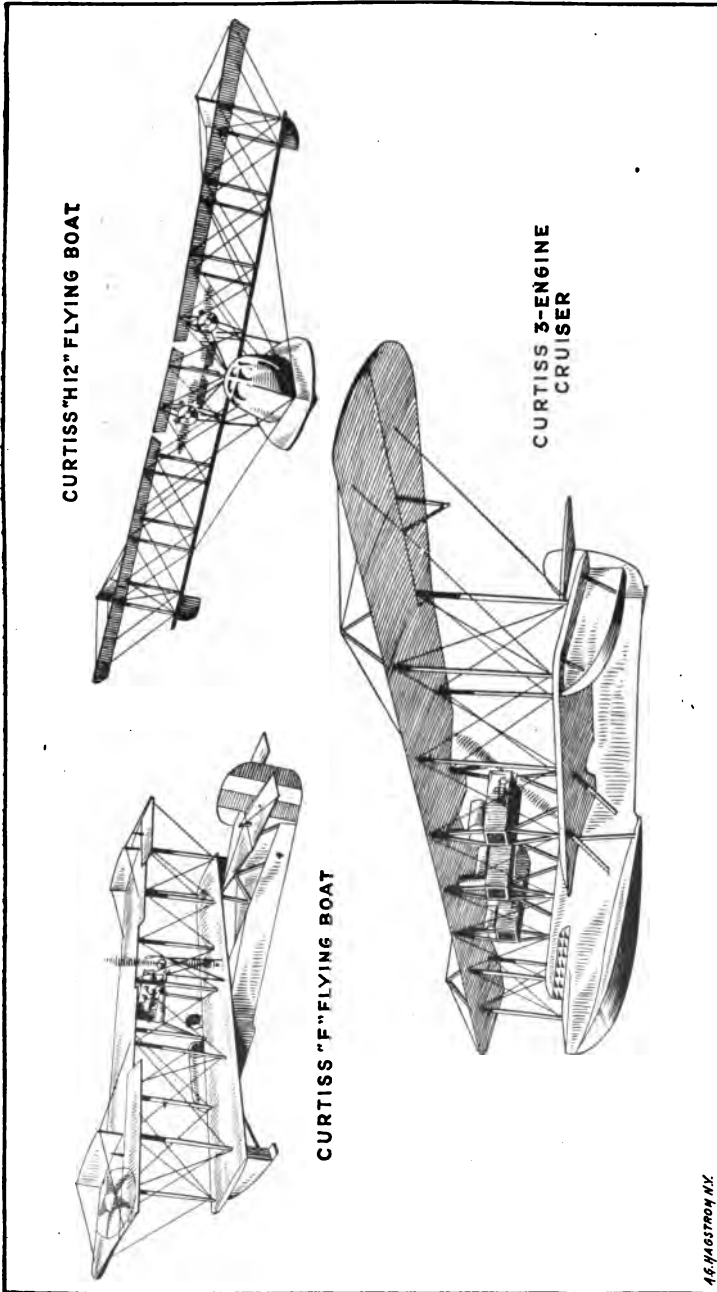


Plate 7. Types of Curtiss Flying Boats Having One, Two, and Three Power Plants.

A. E. JAGSTROM N.Y.

## CHAPTER XI

### INSPECTING AIRPLANE BEFORE FLIGHT

**Inspection of Propeller—Power-Plant—Gasoline and Oil System—Cooling System Parts—Landing Gear—Fuselage Nose—Wing Fittings—Brace Wires—Struts—Ailerons—Rudder—Fuselage Interior—Stabilizers—Control Wires—Tail Skid.**

It is important that all parts of an airplane should be inspected thoroughly before the machine is allowed to leave the ground, and this inspection must be carried on periodically while the machine is in service. The inspection should follow a certain well-devised and logical sequence of events, and should not be done in a haphazard manner. Unless the inspection processes follow logically and in a regular order, the inspectors are very likely to omit some important part that may result in faulty action while in flight. A series of special illustrations which accompany this chapter have been posed by a practical aviator, and are intended to bring out the important points that should receive periodical inspection.

**Inspection of Propeller.**—The first point that should receive attention is the propeller. It should be carefully examined to determine that the blades are in good condition. This means that they should be clean and well polished, and if provided with copper or cloth tips, these should be securely in place. Any splinters or cracks in the blade may result disastrously; and the propeller should be removed unless both blades are absolutely sound. The hub-assembly and the propeller should be inspected with a view to locating any looseness in the propeller hub bolts, or the nuts and cotter pins. After a propeller has been in use for a time the hub flanges may compress the wood and the propeller be loose in the hub. This condition is easily remedied by screwing down the propeller hub flange retention knots until the propeller is securely clamped. Another point that should be looked at

is the method of holding the propeller to the engine shaft. This may be determined by grasping the propeller firmly and shaking it to see if there is any lost motion between the hub and the shaft. If the hub retention nuts have not been properly applied some looseness is apt to develop after the machine has been in flight. A propeller should fit the engine shaft absolutely tight, because any looseness will result in injurious vibration.

**Inspection of Power-Plant.**—The power-plant is the next point which should be thoroughly checked over, and as previously emphasized, the pilot should not accept anybody's

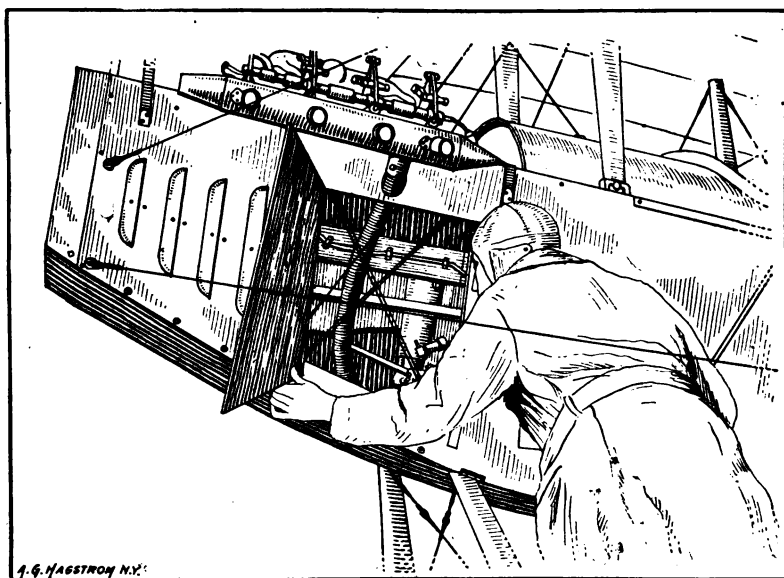


Fig. 117. Examination of Power-Plant Should be Thorough.

opinion that the power-plant is in good condition. He should satisfy himself of this before the machine leaves the ground. The radiator and all water connections should be checked over to see that there are no serious water leaks. It is also important that the radiator be full of water. The oil indicator on the side of the crank case, in some engines, will show the amount of oil there is present in the sump. The external oil

lines, particularly those leading to the oil pressure gauge, should be absolutely tight, and all piping that conveys oil must also be examined to see that the joints are securely fastened and that there is no opportunity for loss of lubricant. The fuel system demands a more rigid inspection than either the cooling or oiling systems because a gasoline leak is apt to be the cause of fire and, of course, should be guarded against.

The points that should be inspected most carefully are the joints in the pipe line at both fuel tank and carburetor. If a gravity feed system is installed, the inspector should make sure that the vent in the tank filler cap is free and clear so that it will admit air to the tank. If a pressure feed system is fitted it is important that the tank cap and piping conveying air pressure be absolutely tight. The relief check valve should be tested to see if the pressure releases at the proper point. Excessive pressure is apt to result in excessive fuel consumption. Of course, it is important that the tank be full of gasoline. The hand pump should be tested to make sure that it is in proper working condition. If a strainer or filtering device is included in the fuel pipe line this should be emptied from time to time to clean out any water or sediment that may be trapped therein.

The engine should be run slowly to make sure that it is firing on all cylinders and then speeded up to be sure that it develops good power. The clearance between the valve operating mechanism and the stems of the intake and exhaust valves should be checked over. All wiring must be clean and the insulation whole. It is important that all connections be tight. The grounding switch for cutting out the magneto should be tested to make sure that it functions properly. The rod or wire connection going from the hand throttle lever to the throttle of the carburetor should be inspected as, if it should become loose in flight, the throttle might jar closed and seriously impair the power production of the engine. Both magneto and carburetor should be firmly attached, the former to the bracket of the engine base, the latter to the induction manifold. The oil pressure should be carefully watched to make sure that it is sufficient for the engine in question. Oil

pressures will vary from twenty to sixty pounds, depending upon the design and type of the engine.

When examining the power-plant, especial attention must be directed to the parts of the magneto that have to do with the timing and distribution of the ignition current. This means that the distance between the breaker points should be checked to make sure that it is adequate and it is well to

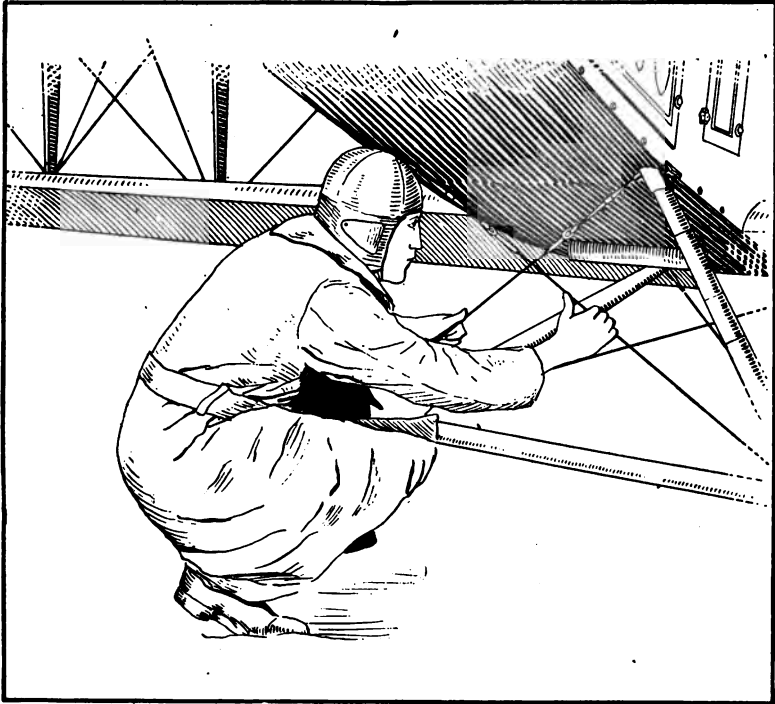


Fig. 118. Examining Landing Gear Bracing Wires.

remove the distributor board to examine the contact brushes and the current distributing segments if there is any tendency for the engine to misfire slightly.

**Landing Gear Inspection.**—While at the front end of the airplane the next logical point to inspect will be the landing gear. The point that should receive attention first is the tension of the bracing wires that run from the fuselage longerons to the landing gear strut fittings. Next, the attachment of



the wiring to the eyebolts in the landing gear and the security wiring on the turnbuckles. All the nuts and bolts on the strut sockets should be examined to make sure that none of the nuts have loosened up, and that all the cotter pins are in place. Examine the wheels to see that there are no loose or broken spokes and that the wheels run true. See that the tires are properly inflated and make sure that they have no weak spots or cuts in the casing that might result in a blow-out when landing.

The wheels should be tested to make sure that they run freely on the axle and the lock member holding the wheel in place on the axle should be inspected to make sure that it is securely in place. The shock-absorber rubber should be wound evenly and have the proper tension and should be clean. In some types of airplanes, the oil will drip from the engine compartment and flood over the rubber shock absorbers, which produces the rotting effect on the cable, thereby weakening it and resulting in premature depreciation. The wooden fairing on the axle should be inspected to make sure that it is not cracked or split and that there are no splintered pieces projecting from it.

**Fuselage Nose Parts.**—While at the front end of the machine, examine carefully the front end of the fuselage to make sure that the radiator is properly secured to the carrier plate and that the carrier or nose plate is properly secured to the front end of the fuselage longerons. The engine bed and engine retaining bolts should be examined to make sure that all parts are held tight. The wire braces in the fuselage should be examined with special care in the front compartment, as considerable strength is imparted to the engine carrying portion of the fuselage by these wires. They should be tight and the turnbuckles should be well safety wired. Another point at the fuselage nose is the anchorage of the wind drag bracing, or the drift wires as they are called. Two of these are found on each side of some types of airplanes, one leading to the lower wing, the other to the upper wing. The soldered ends of these wires should be examined to see that the retention fittings are in the proper tension. Another point that demands inspection

is the fastening of the motor compartment cowls and the motor hood cover. These must be secured and all screws that hold them to the fuselage should be in place. Special care is needed in examining any inspection doors in the motor compartments, as these are apt to be left unsecurely fastened and on some types of machines may open up and shake around when the machine is flying.

**Wing Fittings and Struts.**—The next points to examine are the wing panels and the points of attachment to the fuselage.

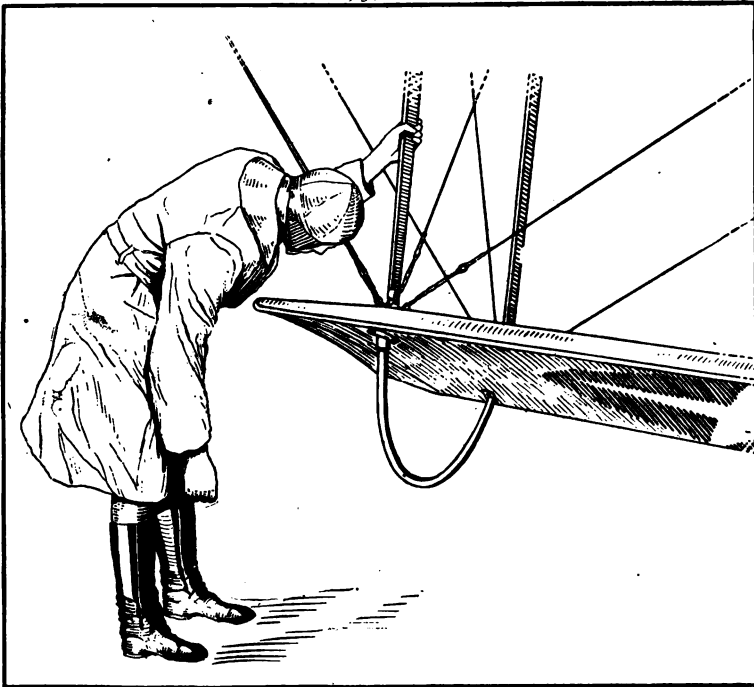
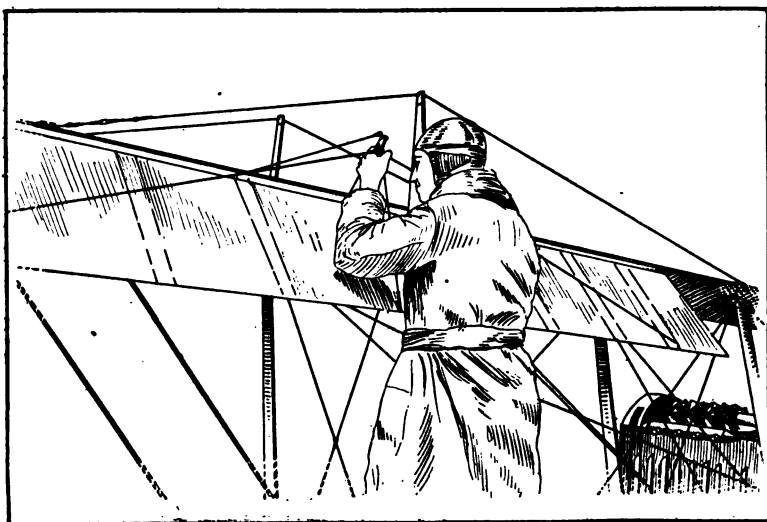


Fig. 119. Examining Wing Fitting and Landing and Flying Wires.

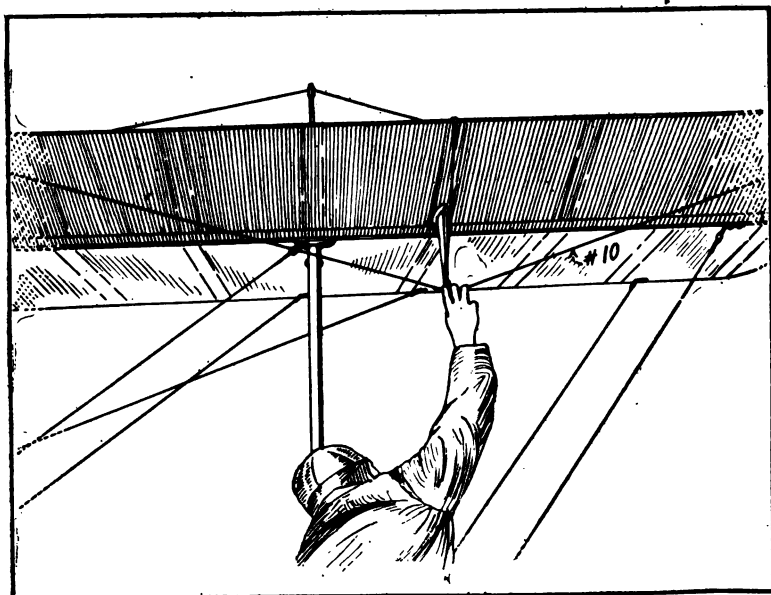
The best method of doing this is to examine completely the wing panels on one part of the machine before taking those on the other side. There are four points of attachment for the wings on each side of the fuselage, two for the upper wing and two for the lower. The wing fitting pins should be in place and properly cotted and safety wired. When this point has been checked off, the flying wires should be examined, one

after the other. On those types of machines where double flying wires are used, it is imperative that equal attention be paid to each wire. The wires should not only have the required tension, but should not be so tight that the struts between the wings are bowed. The struts should be good, clear wood and have no knots or curly grains. After the flying wires have been checked over, the landing wires which are the single cables should be inspected. While these are not as important as the flying wires, at the same time they should have the proper attention and all fittings should be secured. All wires and turnbuckles should be cleaned and greased with graphite and hard grease to prevent all chance of rusting. The wing fittings at the base of all the struts should show no signs of distortion, and any extending tongues to which bracing wiring is attached should not be bent in such a way that the wire cannot exert a straight pull. The bolts going through the sockets at the base of the struts and through the wing fittings should be properly tightened, and the nut on each bolt should be retained with a cotter pin. The struts should not be loose in the wing fittings. This can be ascertained by hitting the side of the strut a sharp blow with the open hand at a point near the fitting. Any lost motion or looseness will be made evident by a clicking noise at the fitting. The incidence wires should be tight, as well as the landing and flying wires. These are the wires that go from the top of a pair to the bottom of the other of the same pair and are clearly shown in Fig. 101 in preceding chapter.

**Inspecting Ailerons.**—An important member of the control system that should be inspected as part of the wing panel is the aileron or balancing flap. This should be easily operated and should not be distorted or bent in any way. The various points of the hinge assembly should be gone over to make sure that the pins are not unduly worn and that they are securely fastened. A few drops of oil should be applied to the hinges periodically and if the aileron is removed for any reason, oil and graphite should be introduced between the hinge pin and its bearing. The control wire connections at the control wire, or pylon, should be checked over one by one to insure that all



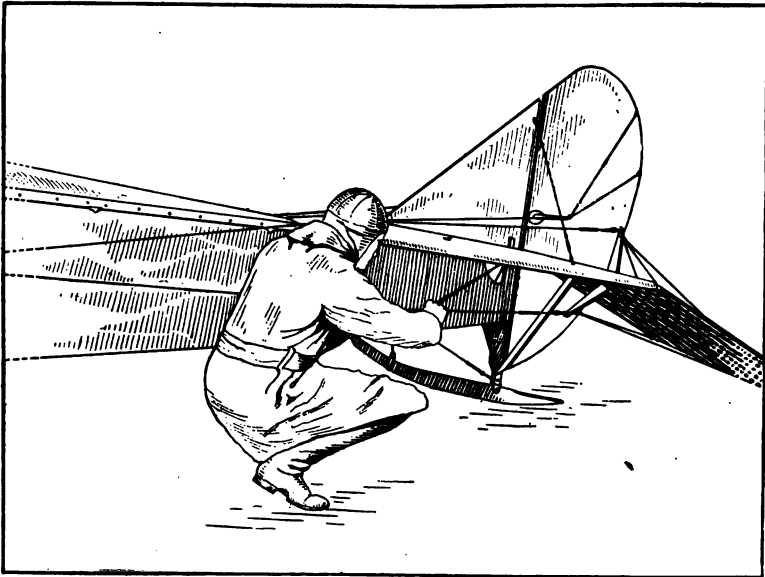
**Fig. 120. Looking Over Top Control Horn on Aileron.**



**Fig. 121. Inspecting Lower Control Horn on Aileron.**

clevis pins are properly fitted and that the wire ends leading to the clevises have secure joints. Special attention should be paid to control wires as if these are frayed at any point they should be replaced at once. The pulleys over which control wires run should be inspected for cracks and should be greased to make sure that they will be free running. All ailerons are checked in turn. On some types of machines but two ailerons are used, one on each top wing, while on others four are provided, one on each wing tip.

**Fuselage Interior.**—Before working down to the empennage, or tail of the machine, the cover should be taken off of



**Fig. 122. Examining Control Wires.**

the fuselage and the various wires used for bracing or control purposes should be checked over to see that they are at the required degrees of tautness, that none of the fittings are cracked or broken, and that all turnbuckles are properly safety wired throughout the fuselage. The inspection of the fuselage is an especially important matter in event of the machine having made a rough landing, or having been in use on service that required frequent "taking-offs" and landings

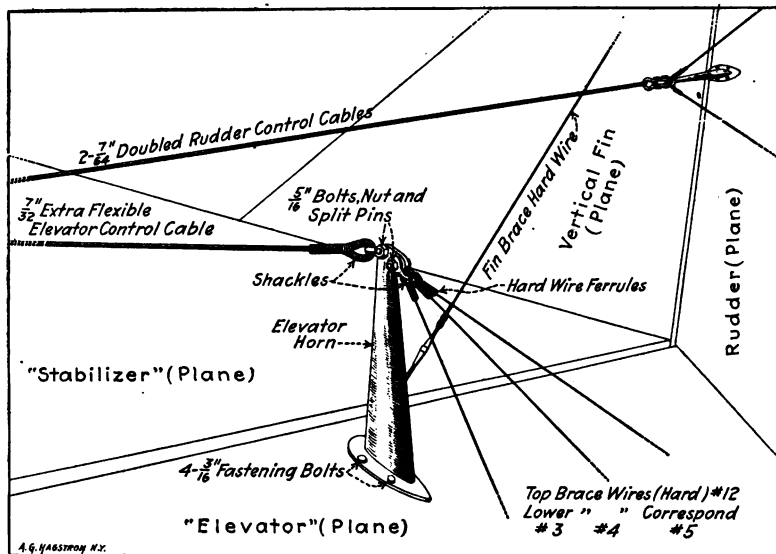


Fig. 123. Control Pylon of Elevator Showing Wire Control Cable and Hard Wire Bracing.

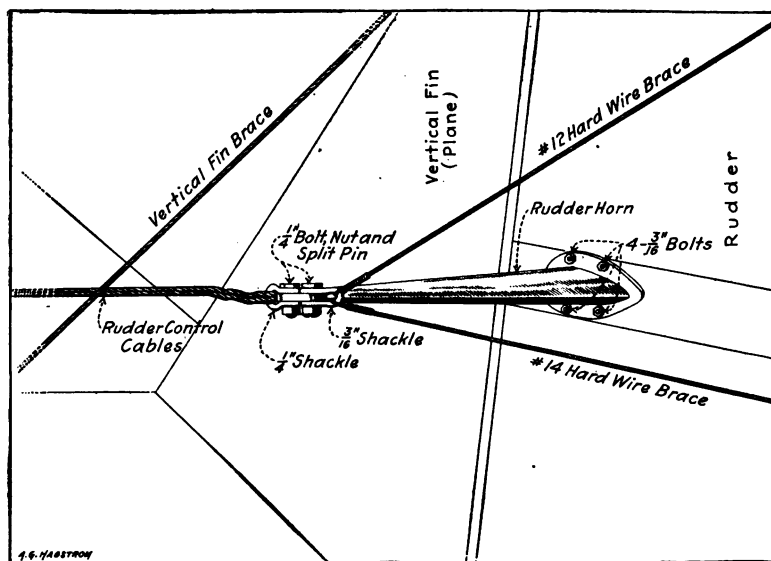


Fig. 124. Control Horn of Rudder Showing Double Control Cable, Clevises, and Hard Bracing Wires.

as instructions at an aviation school. A rough landing is very apt to loosen up the brace wires in the fuselage, especially if a tail-low landing is made and the strain is taken by the tail skid before the wheels touch the ground.

**Stabilizers and Control Wires.**—In examining the horizontal stabilizer, the only points that demand special attention are the bolts that hold it in place on the fuselage and also the braces that extend from each side of the rudder posts to the under side of the stabilizer. In examining the elevators, the

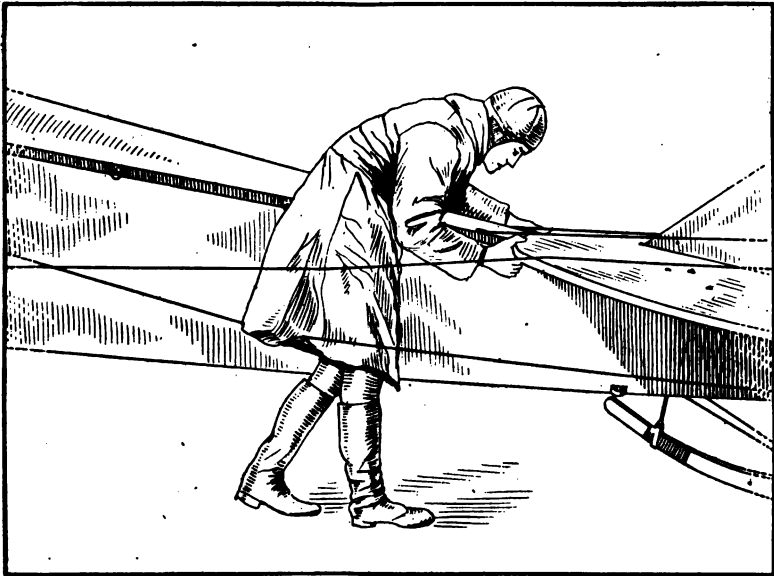
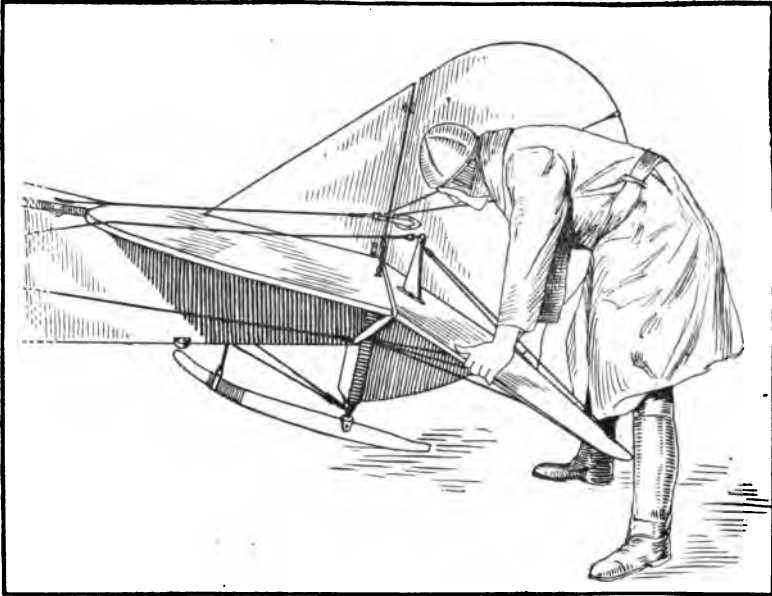


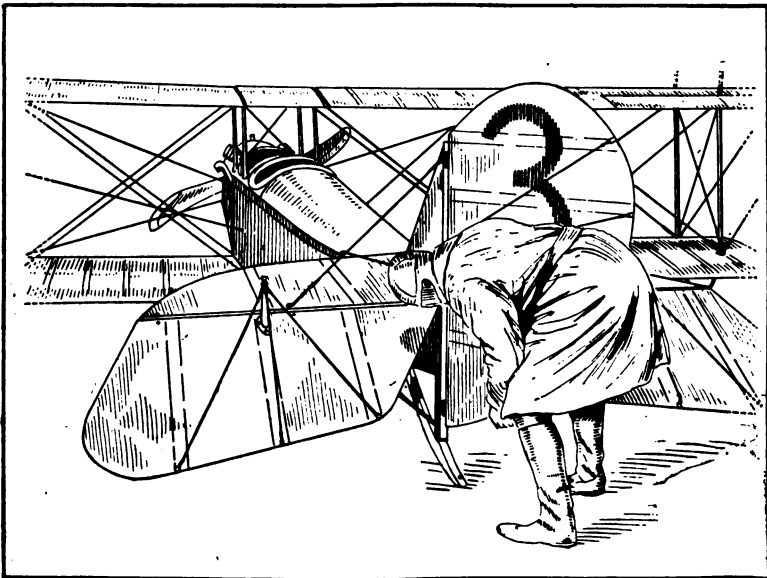
Fig. 125. Testing Stabilizer Attachment to Fuselage.

hinge assembly by which they are attached to the rear end of the horizontal stabilizer and the control horn should be gone over carefully. The same applies to the rudder, only in this case the hinge assembly is attached to the rudder post at the rear end of the fuselage. What has been said in regard to the bearing points and control wires of the other control surfaces apply just as well to those of the rudder.

Just ahead of the rudder a vertical stabilizer fin is installed. The only points about this that demand attention are the bracing wires and the bolts and nuts by which these are fastened



**Fig. 126. Testing Elevators and Attachment to Stabilizer.**



**Fig. 127. Testing Rudder Post and Landing Gear.**



to the horizontal stabilizer. While at the rear end of the machine the tail skid should be looked over with special reference to the supporting hinge or swivel which is attached to the tail post of the fuselage, also to make sure that the wood is not cracked or splintered. The tail skids of most airplanes are provided with a removable shoe of steel which forms a rubbing surface when the tail skid tracks on the ground, as in flying or "taxi-ing." As soon as this shoe shows signs of wear it should be removed and replaced with a new one, as this will save the tail skid and is much easier to do than replacing an entire tail skid member. Special attention should be paid to the shock absorber rubber of the tail skid.

The wing skids at the end of each wing on a machine of considerable spread should be looked at to make sure that these are properly secured and not cracked. The control system parts should be checked over periodically and operated to make sure that all the control surfaces operate as they should. In the Dep. control, the cable passes over a drum having a series of grooves cut into it to form a continuous spiral around which the control wire is wrapped. The drum around which the wire is coiled is not always of large diameter, and if wire of exceptional stiffness is used, or one that is not exactly the proper size, it is apt to fray, due to the sharp turn it is forced to make whenever the control is operated.

If the machine is provided with a stick control, special attention should be given to the universal joints which make it possible to move the stick forward and the control bar sideways at the same time. Naturally, every one of the multiplicity of connections at the control horns must be examined in connection with checking over the control system. Points that are apt to be neglected, such as where the wire runs inside the fuselage, are those which really demand inspection oftenest. By checking over the points enumerated carefully to ascertain if the machine is in proper flying condition before it leaves the ground, all danger of accident when in the air is minimized.

## CHAPTER XII

### STANDARD AIRPLANE NOMENCLATURE

Definitions of All Terms Used in Connection with Aviation Approved by National Advisory Committee for Aeronautics.

FOR the information of those interested in aeronautics the following nomenclature has been prepared as a guide, with a view to eliminating the duplication of terms, the erroneous use of terms, and confusion of terms, and to define the principal terms which have come into use in the development of aeronautics. In the preparation of this nomenclature only those terms have been defined which are peculiar to this subject.

**AEROFOIL:** A winglike structure, flat or curved, designed to obtain reaction upon its surface from the air through which it moves.

**AEROPLANE:** See Airplane.

**AILERON:** A movable auxiliary surface used to produce a rolling moment about the fore-and-aft axis.

**AIRCRAFT:** Any form of craft designed for the navigation of the air—airplanes, balloons, dirigibles, helicopters, kites, kite balloons, ornithopters, gliders, etc.

**AIRPLANE:** A form of aircraft heavier than air which has wing surfaces for support in the air, with stabilizing surfaces, rudders for steering, and power-plant for propulsion through the air. This term is commonly used in a more restricted sense to refer to airplanes fitted with landing gear suited to operation from the land. If the landing gear is suited to operation from the water, the term "seaplane" is used. (See definition.)

*Pusher.*—A type of airplane with the propeller in the rear of the engine.

*Tractor.*—A type of airplane with the propeller in front of the engine.

**AIR-SPEED METER:** An instrument designed to measure the speed of an aircraft with reference to the air.

**ALTIMETER:** An aneroid mounted on an aircraft to indicate continuously its height above the surface of the earth.

**ANEMOMETER:** Any instrument for measuring the velocity of the wind.

**ANGLE:**

*Of attack or of incidence of an aerofoil.*—The acute angle between the direction of the relative wind and the chord of an aerofoil; *i.e.*, the angle between the chord of an aerofoil and its motion relative to the air. (This definition may be extended to any body having an axis.)

*Critical.*—The angle of attack at which the lift curve has its first maximum; sometimes referred to as the “burble point.” (If the “lift curve” has more than one maximum, this refers to the first one.)

*Gliding.*—The angle the flight path makes with the horizontal when flying in still air under the influence of gravity alone, *i.e.*, without power from the engine.

**APPENDIX:** The hose at the bottom of a balloon used for inflation. In the case of a spherical balloon it also serves for equalization of pressure.

**ASPECT RATIO:** The ratio of span to chord of an aerofoil.

**AVIATOR:** The operator or pilot of heavier-than-air craft. This term is applied regardless of the sex of the operator.

**AXES OF AN AIRCRAFT:** Three fixed lines of reference, usually centroidal and mutually rectangular.

The principal longitudinal axis in the plane of symmetry, usually parallel to the axis of the propeller, is called the fore-and-aft axis (or longitudinal axis); the axis perpendicular to this in the plane of symmetry is called the vertical axis; and the third axis, perpendicular to the other two, is called the transverse axis (or lateral axis). In mathematical discussions the first of these axes, drawn from front to rear, is called the X axis; the second, drawn upward the Z axis; and the third, forming a “left-handed” system, the Y axis.

**BALANCING FLAPS:** See Aileron.

**BALLOON:** A form of aircraft comprising a gas bag and a basket. The support in the air results from the buoyancy of the air displaced by the gas bag, the form of which is maintained by the pressure of a contained gas lighter than air.

*Barrage.*—A small spherical captive balloon, raised as a protection against attacks by airplanes.

*Captive.*—A balloon restrained from free flight by means of a cable attaching it to the earth.

*Kite.*—An elongated form of captive balloon, fitted with tail appendages to keep it headed into the wind, and deriving increased lift due to its axis being inclined to the wind.

*Pilot.*—A small spherical balloon sent up to show the direction of the wind.

*Sounding.*—A small spherical balloon sent aloft, without passengers, but with registering meteorological instruments.

**BALLOON BED:** A mooring place on the ground for a captive balloon.

**BALLOON CLOTH:** The cloth, usually cotton, of which balloon fabrics are made.

**BALLOON FABRIC:** The finished material, usually rubberized, of which balloon envelopes are made.

**BALLOONET:** A small balloon within the interior of a balloon or dirigible for the purpose of controlling the ascent or descent, and for maintaining pressure on the outer envelope so as to prevent deformation. The balloonet is kept inflated with air at the required pressure, under the control of a blower and valves.

**BANK:** To incline an airplane laterally—*i.e.*, to roll it about the fore-and-aft axis. Right bank is to incline the airplane with the right wing down. Also used as a noun to describe the position of an airplane when its lateral axis is inclined to the horizontal.

**BAROGRAPH:** An instrument used to record variations in barometric pressure. In aeronautics the charts on which the records are made indicate altitudes directly instead of barometric pressures.

- BASKET:** The car suspended beneath a balloon, for passengers, ballast, etc.
- BIPLANE:** A form of airplane in which the main supporting surface is divided into two parts, one above the other.
- BODY OF AN AIRPLANE:** The structure which contains the power-plant, fuel, passengers, etc.
- BONNET:** The appliance, having the form of a parasol, which protects the valve of a spherical balloon against rain.
- BRIDLE:** The system of attachment of cable to a balloon, including lines to the suspension band.
- BULL'S-EYES:** Small rings of wood, metal, etc., forming part of balloon rigging, used for connection or adjustment of ropes.
- BURBLE POINT:** See Angle, critical.
- CABANE:** A pyramidal framework upon the wing of an airplane, to which stays, etc., are secured.
- CAMBER:** The convexity or rise of the curve of an aerofoil from its chord, usually expressed as the ratio of the maximum departure of the curve from the chord to the length of the chord. "Top camber" refers to the top surface of an aerofoil, and "bottom camber" to the bottom surface; "mean camber" is the mean of these two.
- CAPACITY:** See Load.  
The cubic contents of a balloon.
- CENTER:** *Of pressure of an aerofoil.*—The point in the plane of the chords of an aerofoil, prolonged if necessary, through which at any given attitude the line of action of the resultant air force passes. (This definition may be extended to any body.)
- CHORD:**  
*Of an aerofoil section.*—A right line tangent at the front and rear to the under curve of an aerofoil section.  
*Length.*—The length of the chord is the length of the projection of the aerofoil section on the chord.
- CLINOMETER:** See Inclinator.
- CONCENTRATION RING:** A hoop to which are attached the ropes suspending the basket.
- CONTROL COLUMN:** The vertical lever by means of which cer-

tain of the principal controls are operated, usually those for pitching and rolling.

**CONTROLS:** A general term applying to the means provided for operating the devices used to control speed, direction of flight, and attitude of an aircraft.

**CROW'S FOOT:** A system of diverging short ropes for distributing the pull of a single rope.

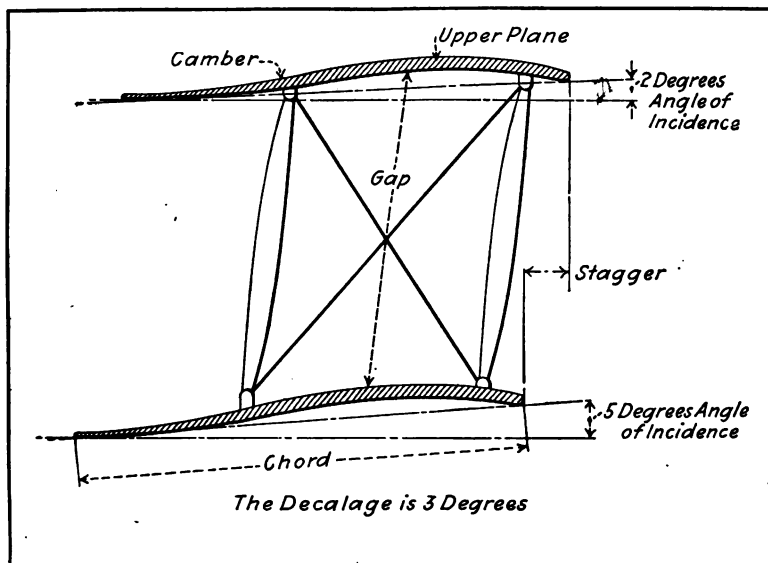


Fig. 128. Showing *Décilage*.

**DÉCALAGE:** The angle between the chords of the principal and the tail planes of a monoplane. The same term may be applied to the corresponding angle between the direction of the chord or chords of a biplane and the direction of a tail plane. (This angle is also sometimes known as the longitudinal V of the two planes.) (Fig. 128, showing *Décilage*.)

**DIHEDRAL IN AN AIRPLANE:** The angle included at the intersection of the imaginary surfaces containing the chords of the right and left wings (continued to the plane of symmetry if necessary). This angle is measured in a plane perpendicular to that intersection. The measure of the

dihedral is taken as 90 degrees minus one-half of this angle as defined.

The dihedral of the upper wing may and frequently does differ from that of the lower wing in a biplane.

**DIRIGIBLE:** A form of balloon, the outer envelope of which is of elongated form, provided with a propelling system, car, rudders, and stabilizing surfaces.

*Non-rigid.*—A dirigible whose form is maintained by the pressure of the contained gas assisted by the car-suspension system.

*Rigid.*—A dirigible whose form is maintained by a rigid structure contained within the envelope.

*Semirigid.*—A dirigible whose form is maintained by means of a rigid keel and by gas pressure.

**DIVING RUDDER:** See Elevator.

**DOPE:** A general term applied to the material used in treating the cloth surface of airplane members and balloons to increase strength, produce tautness, and act as a filler to maintain air-tightness; it usually has a cellulose base.

**DRAG:** The component parallel to the relative wind of the total force on an aircraft due to the air through which it moves.

That part of the drag due to the wings is called "wing resistance" (formerly called "drift"); that due to the rest of the airplane is called "parasitic resistance" (formerly called "head resistance").

**DRIFT:** See Drag. Also used as synonymous with "leeway," *q. v.*

**DRIFT METER:** An instrument for the measurement of the angular deviation of an aircraft from a set course, due to cross winds.

**DRIP CLOTH:** A curtain around the equator of a balloon, which prevents rain from dripping into the basket.

**ELEVATOR:** A hinged surface for controlling the longitudinal attitude of an aircraft; *i. e.*, its rotation about the transverse axis.

**EMPENNAGE:** See Tail.

**ENTERING EDGE:** The foremost edge of an aerofoil or propeller blade.

**ENVELOPE:** The portion of the balloon or dirigible which contains the gas.

**EQUATOR:** The largest horizontal circle of a spherical balloon.

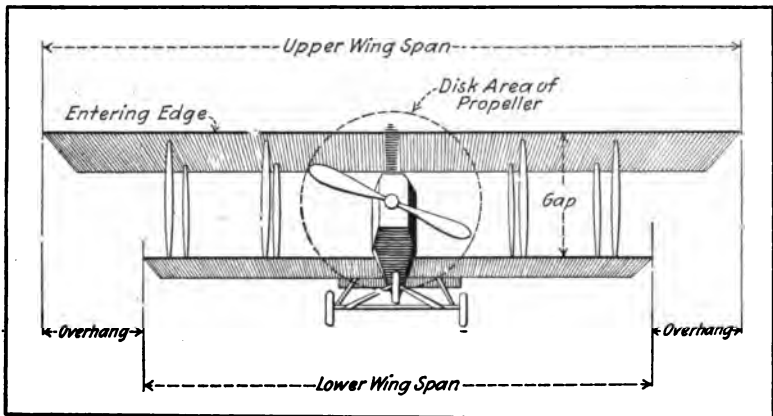


Fig. 129. Showing Entering Edge.

**FINS:** Small fixed aerofoils attached to different parts of aircraft, in order to promote stability; for example, tail fins, skid fins, etc. Fins are often adjustable. They may be either horizontal or vertical.

**FLIGHT PATH:** The path of the center of gravity of an aircraft with reference to the earth.

**FLOAT:** That portion of the landing gear of an aircraft which

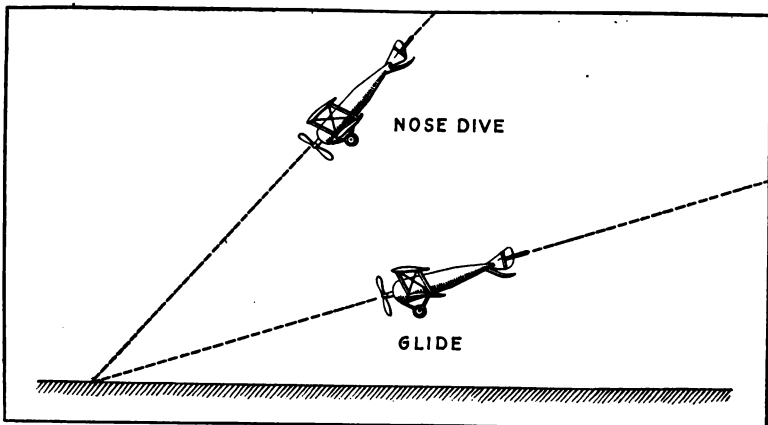


Fig. 130. Outlining Difference between Nose Dive and Glide.



provides buoyancy when it is resting on the surface of the water.

**FUSELAGE:** See Body.

**GAP:** The shortest distance between the planes of the chords of the upper and lower wings of a biplane.

**GAS BAG:** See Envelope.

**GLIDE:** To fly without engine power.

**GLIDER:** A form of aircraft similar to an airplane, but without any power-plant.

When utilized in variable winds it makes use of the soaring principles of flight and is sometimes called a soaring machine.

**GORE:** One of the segments of fabric composing the envelope.

**GROUND CLOTH:** Canvas placed on the ground to protect a balloon.

**GUIDE ROPE:** The long trailing rope attached to a spherical balloon or dirigible, to serve as a brake and as a variable ballast.

**GUY:** A rope, chain, wire, or rod attached to an object to guide or steady it, such as guys to wing, tail, or landing gear.

**HANGAR:** A shed for housing balloons or airplanes.

**HELICOPTER:** A form of aircraft whose support in the air is derived from the vertical thrust of propellers.

**HORN:** A short arm fastened to a movable part of an airplane, serving as a lever-arm, *e.g.*, aileron-horn, rudder-horn, elevator-horn.

**INCLINOMETER:** An instrument for measuring the angle made by any axis of an aircraft with the horizontal, often called a clinometer.

**INSPECTION WINDOW:** A small transparent window in the envelope of a balloon or in the wing of an airplane to allow inspection of the interior.

**KITE:** A form of aircraft without other propelling means than the towline pull, whose support is derived from the force of the wind moving past its surface.

**LANDING GEAR:** The understructure of an aircraft designed to carry the load when resting on or running on the surface of the land or water.

**LEADING EDGE:** See Entering edge.

**LEEWAY:** The angular deviation from a set course over the earth, due to cross currents of wind, also called drift; hence, "drift meter."

**LIFT:** The component perpendicular to the relative wind, in a vertical plane, of the force on an aerofoil due to the air pressure caused by motion through the air.

**LIFT BRACING:** See Stay.

**LOAD:**

*Dead.*—The structure, power-plant, and essential accessories of an aircraft.

*Full.*—The maximum weight which an aircraft can support in flight; the "gross weight."

*Useful.*—The excess of the full load over the dead-weight of the aircraft itself, *i.e.*, over the weight of its structure, power-plant, and essential accessories. (These last must be specified.)

**LOADING:** See Wing Loading.

**LOBES:** Bags at the stern of an elongated balloon designed to give it directional stability.

**LONGERON:** See Longitudinal.

**LONGITUDINAL:** A fore-and-aft member of the framing of an airplane body, or of the floats, usually continuous across a number of points of support.

**MONOPLANE:** A form of airplane whose main supporting surface is a single wing, extending equally on each side of the body.

**MOORING BAND:** The band of tape over the top of a balloon to which are attached the mooring ropes.

**NACELLE:** See Body. Limited to pushers.

**NET:** A rigging made of ropes and twine on spherical balloons, which supports the entire load carried.

**ORNITHOPTER:** A form of aircraft deriving its support and propelling force from flapping wings.

**PANEL:** The unit plane section of which the airplane is made.

**PARACHUTE:** An apparatus made like an umbrella, used to retard the descent of a falling body.

**PATCH SYSTEM:** A system of construction in which patches (or adhesive flaps) are used in place of the suspension band.

**PERMEABILITY:** The measure of the loss of gas by diffusion through the intact balloon fabric.

**PITOT TUBE:** A tube with an end open square to the fluid stream, used as a detector of an impact pressure. It is usually associated with a coaxial tube surrounding it, having perforations normal to the axis for indicating static pressure; or there is such a tube placed near it and parallel to it, with a closed conical end and having perforations in its side. The velocity of the fluid can be determined from the difference between the impact pressure and the static pressure, as read by a suitable gauge. This instrument is often used to determine the velocity of an aircraft through the air.

**PONTOONS:** See Float.

**PUSHER:** See Airplane.

**PYLON:** A mast or pillar serving as a marker of a course.

**RACE OF A PROPELLER:** See Slip stream.

**RELATIVE WIND:** The motion of the air with reference to a moving body. Its direction and velocity, therefore, are found by adding two vectors, one being the velocity of the air with reference to the earth, the other being equal and opposite to the velocity of the body with reference to the earth.

**RIP CORD:** The rope running from the rip panel of a balloon to the basket, the pulling of which causes immediate deflation.

**RIP PANEL:** A strip in the upper part of a balloon which is torn off when immediate deflation is desired.

**RUDDER:** A hinged or pivoted surface, usually more or less flat or streamlined, used for the purpose of controlling the attitude of an aircraft about its "vertical" axis, *i.e.*, for controlling its lateral movement.

*Rudder bar.*—The foot bar by means of which the rudder is operated.

**SEAPLANE:** A particular form of airplane in which the landing gear is suited to operation from the water.

**SERPENT:** A short, heavy guide rope.

**SIDE SLIPPING:** Sliding downward and inward when making a turn; due to excessive banking. It is the opposite of skidding.

**SKIDDING:** Sliding sideways away from the center of the turn in flight. It is usually caused by insufficient banking in a turn, and is the opposite of side slipping.

**SKIDS:** Long wooden or metal runners designed to prevent nosing of a land machine when landing or to prevent dropping into holes or ditches in rough ground. Generally designed to function should the landing gear collapse or fail to act.

**SLIP STREAM OR PROPELLER RACE:** The stream of air driven aft by the propeller and with a velocity relative to the airplane greater than that of the surrounding body of still air.

**SPREAD:** The maximum distance laterally from tip to tip of an airplane wing.

**STABILITY:** The quality of an aircraft in flight which causes it to return to a condition of equilibrium when meeting a disturbance (This is sometimes called "dynamical stability.")

*Directional.*—Stability with reference to the vertical axis.

*Inherent.*—Stability of an aircraft to the disposition and arrangement of its fixed parts.

*Lateral.*—Stability with reference to the longitudinal (or fore-and-aft) axis.

*Longitudinal.*—Stability with reference to the lateral (or athwartship) axis.

**STABILIZER:** See Fins.

*Mechanical.*—Any automatic device designed to secure stability in flight.

**STAGGER:** The amount of advance of the entering edge of the upper wing of a biplane over that of the lower; it is considered positive when the upper surface is forward.

**STALLING:** A term describing the condition of an airplane which from any cause has lost the relative speed necessary for steerageway and control.

- STATOSCOPE:** An instrument to detect the existence of a small rate of ascent or descent, principally used in ballooning.
- STAY:** A wire, rope or the like, used as a tie-piece to hold parts together, or to contribute stiffness; for example, the stays of the wing and body trussing.
- STEP:** A break in the form of the bottom of a float.
- STREAMLINE FLOW:** A term in hydromechanics to describe the condition of continuous flow of a fluid, as distinguished from eddying flow, where discontinuity takes place.
- STREAMLINE SHAPE:** A shape intended to avoid eddying or discontinuity and to preserve streamline flow, thus keeping resistance to progress at a minimum.
- STRUT:** A compression member of a truss frame; for instance, the vertical members of the wing truss of a biplane.
- SWEEP BACK:** The horizontal angle between the lateral (athwartship) axis of an airplane and the entering edge of the main planes.
- TAIL:** The rear portion of an aircraft, to which are usually attached rudders, elevators, and fins.
- TAIL FINS:** The vertical and horizontal surfaces attached to the tail, used for stabilizing.
- THRUST DEDUCTION:** Due to the influence of the propellers, there is a reduction of pressure under the stern of the vessel which appreciably reduces the total propulsive effect of the propeller. This reduction is termed "thrust deduction."
- TRAILING EDGE:** The rearmost portion of an aerofoil.
- TRIPANE:** A form of airplane whose main supporting surfaces are divided into three parts, superposed.
- TRUSS:** The framing by which the wing-loads are transmitted to the body; comprises struts, stays and spars.
- VELOMETER:** See Air-Speed meter and anemometer.
- VOL-PIQUE:** See Nose Dive. (Fig. 130).
- VOLPLANE:** See Glide.
- WAKE GAIN:** Due to the influence of skin friction, eddying, etc., a vessel in moving forward produces a certain forward movement of the fluid surrounding it. The effect of this is to reduce the effective resistance of the hull, and this effect, due to the forward movement of the wake, is termed the

“wake gain.” In addition to this effect the forward movement of this body of fluid reduces the actual advance of the propeller through the surrounding medium, thereby reducing the propeller horse-power.

**WARP:** To change the form of the wing by twisting it, usually by changing the inclination of the rear spar relative to the front spar.

**WING:** The main supporting surfaces of an airplane.

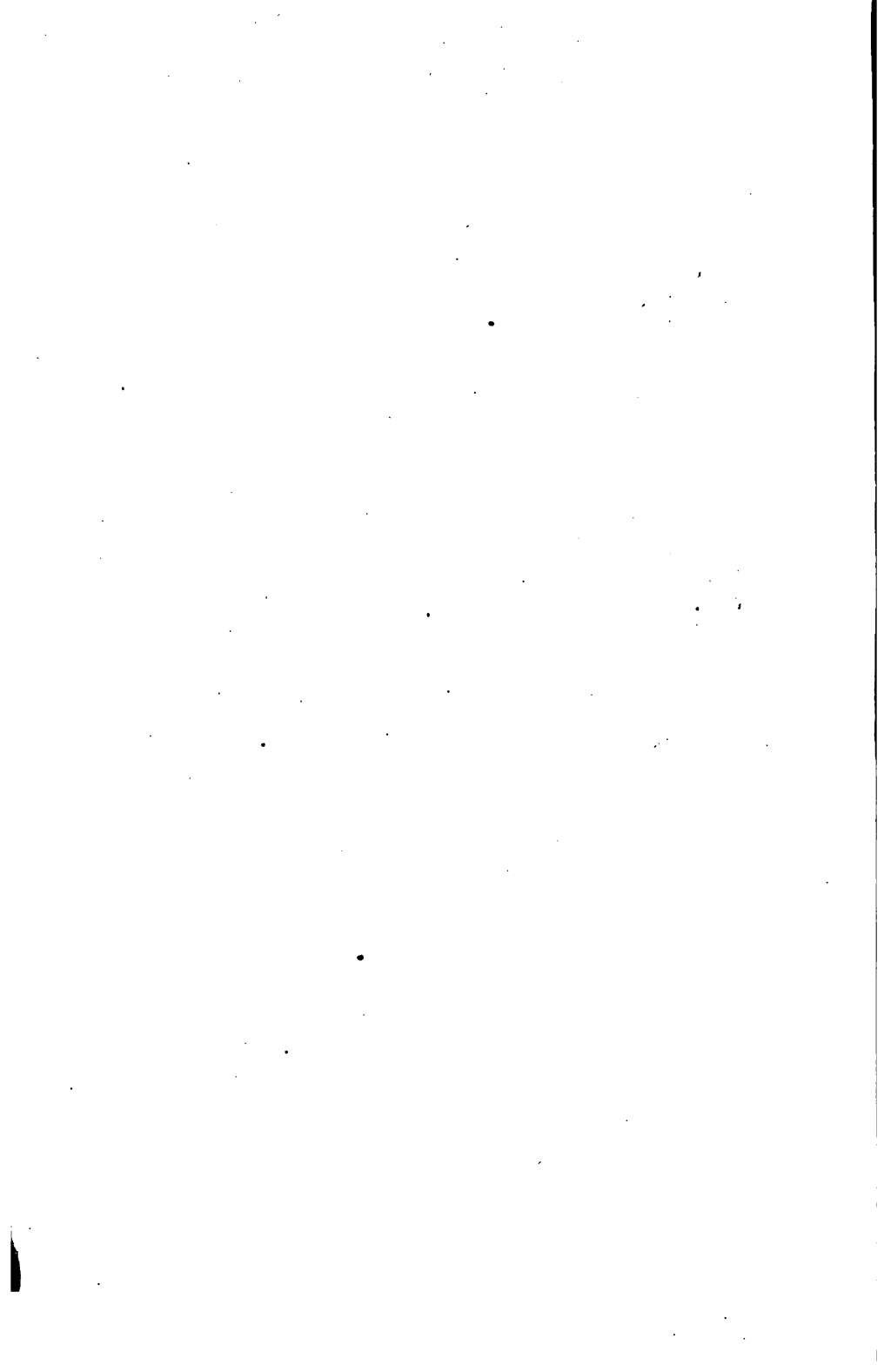
**WING LOADING:** The weight carried per unit area of supporting surface.

**WING RIB:** A fore-and-aft member of the wing structure used to support the covering and to give the wing section its form.

**WING SPAR:** An athwartship member of the wing structure resisting tension and compression.

**YAW:** To swing off the course about the vertical axis, owing to gusts or lack of directional stability.

*Angle of.*—The temporary angular deviation of the fore-and-aft axis from the course.



# INDEX

## A

	PAGE.
Ader's, and Other Machines . . . . .	41
Advancing Edge Width . . . . .	43
Advantage of Cambered Aerofoil . . . . .	62
Advantages of Fuselage . . . . .	113
Aerial Motors Must be Light . . . . .	137
Aerofoil Camber, Effect of . . . . .	69
Aerofoil Experiments . . . . .	54
Aerofoil Sections—Fast and Slow Planes . . . . .	67
Aerofoil Sections, Resistance of . . . . .	22
Aerofoil Sections—Special Work . . . . .	68
Aerofoil Thickness—Lift . . . . .	70
Aerofoils, Design and Construction . . . . .	54
Aerofoils, Pressure Distribution on . . . . .	71
AGO Tractor Biplane . . . . .	95
Aileron Function . . . . .	53
Aileron Projections . . . . .	183
Air-Cooled Engines . . . . .	143
Air, Description of . . . . .	13
Aircraft Motors Balance . . . . .	136
Aircraft Motors Must be Most Reliable . . . . .	136
Aircraft Motors Nearest to Perfection . . . . .	136
Aircraft, Types of . . . . .	13
Air in Motion, Cause of . . . . .	14
Air in Motion, Force of . . . . .	13
Air in Motion, Kite Supported by . . . . .	19
Air, Navigation of the . . . . .	13
Air, Perfect Liquid . . . . .	154
Airplane and Bird, Aspect Ratio of . . . . .	83
Airplane and Bird Flight Compared . . . . .	48
Airplane Balance and Lever Compared . . . . .	51
Airplane Bracing Wires . . . . .	103
Airplane Capable of Flight . . . . .	24
Airplane Construction, New Features . . . . .	42
Airplane Control Methods . . . . .	51
Airplane Design Considerations . . . . .	114
Airplane Engine Forms . . . . .	141
Airplane Engine Installation . . . . .	143
Airplane Equilibrium and Control Principles . . . . .	171
Airplane Fuselage Construction . . . . .	109
Airplane Fuselage Forms . . . . .	117



	PAGE
Airplane in Air, Support of . . . . .	16
Airplane in Flight, Four Forces Acting on . . . . .	172
Airplane in Flight, Three Axes of . . . . .	171
Airplane is Best, Why . . . . .	17
Airplane, Make-up of . . . . .	16
Airplane Most Practical . . . . .	17
Airplane Moves in Three Planes . . . . .	48
Airplane Operation, Principle of . . . . .	17
Airplane Parts of Wood . . . . .	126
Airplane Power Plants . . . . .	136
Airplane Principles, Elementary . . . . .	19
Airplane Propeller Construction and Action . . . . .	152
Airplane, Propulsive Force of . . . . .	20
Airplane Supports Weight—Proof . . . . .	40
Airplane Types, Comparison of Two Accepted . . . . .	93
Airplane Wing Bracing . . . . .	87, 100
Airplane Wing Construction . . . . .	84
Airplane Wing Form . . . . .	93
Airplane Wing, Typical . . . . .	85
Airplane Wings, Side Bracing of . . . . .	102
Airplanes, American Designs . . . . .	229
Airplanes Automatically Stable . . . . .	97
Airplanes, Early Successful . . . . .	55
Airplanes, Early Types . . . . .	39
Airplanes, Foreign Designs . . . . .	230
Airplanes, Three Main Types . . . . .	27
Air "Pocket" . . . . .	189
Air Pressure to Sustain Weight . . . . .	19
Air Pressure, Variation in . . . . .	176
Air Reaction on Airplane Supports Weight . . . . .	40
Air Resistance . . . . .	21
Air Stream Effect on Cambered Plane . . . . .	61
Aligning a Fuselage Having Straight Top Longerons . . . . .	220
American Airplane Designs . . . . .	229
American Seaplane Designs . . . . .	228
Any Airplane Will Fly with Sufficient Power . . . . .	96
Anzani, Installation of . . . . .	151
Arrangement, Construction and Bracing of Airplane Wings . . . . .	96
Arrangement of Landing Gear . . . . .	108
Ascension of Balloons, Causes of . . . . .	14
Ascensional Power of Warm Air . . . . .	14
Aspect Ratio . . . . .	57
Aspect Ratio, High <i>vs.</i> Low . . . . .	81
Aspect Ratio of Airplane and Bird . . . . .	83
Aspect Ratio of Plane . . . . .	43
Atmospheric Force, Examples of . . . . .	19
Attain Altitude and Handle Machine, How to . . . . .	191
Attraction of Gravity . . . . .	18
Automatically Stable Airplanes . . . . .	97

## B

	PAGE
Balance of Aircraft Motors . . . . .	137
Balance of Airplane and Lever Compared . . . . .	51
Balanced Control, Function of . . . . .	183
Balancing of Propeller . . . . .	167
Balancing Principles of Plane . . . . .	50
Balloon Ascensions, Causes of . . . . .	14
Balloon, Desired Rapid Descent of . . . . .	30
Balloon, Make Up of . . . . .	15
Balloon Parts, Spherical . . . . .	28
Balloon Types . . . . .	14
Banking Airplane in Turning . . . . .	183
Best Aerofoil Section . . . . .	66
Best Design of Cambered Aerofoil . . . . .	61
Best Lift, Cambers for . . . . .	11
Best Proportions for Plane . . . . .	43
Biplane Efficiency . . . . .	76
Biplane or Monoplane . . . . .	76
Biplane Spacing, Corrections for . . . . .	78
Biplane vs. Monoplane Bracing . . . . .	100
Bird and Airplane Flight Compared . . . . .	48
Bird and Airplane Flight Differ . . . . .	48
Bird and Plane Flight Compared . . . . .	47
Bird and Plane Form Compared . . . . .	44
Bird Flight Difficult to Imitate . . . . .	48
Birds, Prehistoric . . . . .	63
Birds, Weight and Flying Power of . . . . .	63
Bird's Wing Camber . . . . .	71
Bird's Wings, Loading of . . . . .	62
Bird Wing Forms Followed . . . . .	43
Blade Pitch . . . . .	156
Blade Theory . . . . .	158
Blimp—Dirigible Balloon Typés . . . . .	36
Blimp, Its Construction . . . . .	36
Blimp, Military Value . . . . .	38
Blimp—Non-Rigid Type . . . . .	36
Blimp, Operation in Air . . . . .	38
Box Kite Development . . . . .	19
Braced Biplane Wing Assembly . . . . .	89
Bracing Airplane Wings, Several Methods of . . . . .	102
Bracing Design of Breguet . . . . .	103
Bracing Interplane . . . . .	91
Bracing of Airplane Wing . . . . .	100
Bracing of Martin Design . . . . .	103
Bracing of Typical Wing Structure . . . . .	101
Bracing Sides of Airplane Wings . . . . .	102
Bracing Wings of Airplane . . . . .	87
Bracing Wires on Airplanes . . . . .	103

	PAGE
Breguet Bracing Design.....	103
Burble Point.....	58
Burble Point or Critical Angle.....	74

## C

Cable Ends, Flexible.....	105
Cable Sizes and Strengths.....	105
Cambered Aerofoil, Advantages of.....	62
Cambered Aerofoil, Best Design.....	61
Cambered Aerofoils, Properties of.....	59
Cambered and Flat Planes Compared.....	59
Cambered Plane, Air Stream Effect.....	61
Cambered Plane vs. Flat Plane, Diagram.....	60
Camber of Ribs.....	84
Cambers for Maximum Lift.....	71
Captive Spherical Balloons, Military Value.....	31
Care of Propeller.....	169
Cause of Air in Motion.....	14
Causes of Balloon Ascensions.....	14
Center of Gravity and Pressure.....	174
Center of Gravity, How Obtained.....	120
Center of Gravity Shifting, Effect of.....	175
Center of Pressure.....	58
Center of Pressure, Changes of.....	80
Center of Pressure, How Obtained.....	120
Center of Pressure, Position of.....	74
Changes of Center of Pressure.....	80
Characteristics of American Pre-War Engines.....	150
Coal Gas vs. Hydrogen Gas.....	30
Coincidence of Centers, How Obtained.....	119
Comparing Airplane and Bird Flight.....	48
Comparison of Bird and Plane Form.....	44
Comparison of Cambered and Flat Planes.....	59
Comparison of Plane and Bird Flight.....	47
Comparison of Two Accepted Airplane Types.....	93
Complete Enclosure, Important.....	118
Conditions for Practical Motor.....	138
Considerations of Airplane Design.....	114
Constructing an Airplane, Material Necessary for.....	134
Construction and Bracing of Landing Gear.....	108
Construction of Airplane Fuselage.....	109
Construction of Airplane Wing.....	84
Construction of Blimp.....	36
Construction of Fuselage.....	118
Construction of Zeppelin.....	34
Contraction and Expansion of Gas.....	28
Control by Dep. System.....	181
Control by Instinct.....	50

	PAGE
Control by Sense of Equilibrium Necessary.....	50
Control by Stick System.....	182
Control in Making Turns.....	194
Control Methods of Airplane.....	51
Control Methods of Early Airplanes.....	178
Control of Elevator.....	51
Control of Free Balloons.....	31
Control Principles and Airplane Equilibrium.....	171
Control Surfaces.....	48
Control Systems Standard of To-day.....	181
Corrections for Biplane Spacing.....	78
Critical Angle of Incidence.....	58
Critical Angle or Burble Point.....	74
Curtiss Creation.....	109
Curtiss Flying Boats.....	231
Curtiss JN4.....	223
Curtiss vs. Wright Design, Early.....	110

## D

Danger in Stalling.....	193
Definitions of Propeller.....	158
Definition of Stream Line Body.....	115
Definition of Work.....	138
Dep. Control System.....	181
Description of Air.....	13
Design and Construction of Aerofoils.....	54
Design Considerations of Airplane.....	114
Designing Airplanes, Principles Observed in.....	114
Designing Propellers, Rule Followed in.....	160
Design of Fuselage Framework.....	113
Design of Wing Sections Vary.....	66
Desired Rapid Descent of Balloon.....	30
Details of Thimbles and Turnbuckles.....	104
Determining Supporting Surfaces.....	54
Development of Box Kite.....	19
Diagram-Advantages of Cambered Plane.....	60
Diagram of Lift and Drift Value.....	57
Difference in Airplanes.....	24
Dihedral Angle, Lateral.....	98
Dihedral Angle, Longitudinal.....	97
Dirigible Balloon Types—The Blimp.....	36
Dirigible Balloon Types—The Zeppelin.....	34
Dirigibles, Types of.....	15
Disc Theory.....	157
Distribution of Pressure on Aerofoils.....	71
"Dope" Used for Wings.....	86
Drawback in Lack of Speed.....	42
Dynamic Similarity, Principle of.....	54

## E

	PAGE
Early Airplanes . . . . .	39
Early Airplanes, Control Methods of . . . . .	178
Early Ideas of Plane Forms . . . . .	77
Early Machines Controlled by Instinct . . . . .	50
Early Successful Airplanes . . . . .	55
Early Theory of Flight Power . . . . .	42
Early Wright Starting System . . . . .	111
Effect of Aerofoil Camber . . . . .	69
Effect of Gap . . . . .	77
Effect of Shifting Center of Gravity . . . . .	175
Effect of Stagger . . . . .	79
Effect of Varying Lower Camber . . . . .	70
Effect of Wing Loading on Aerofoil Design . . . . .	65
Efficient Wing Span . . . . .	81
Elementary Airplane Principles . . . . .	19
Elevator Control and Use . . . . .	51
Empennage, Typical of Modern Machine . . . . .	47
End Losses . . . . .	59
Engine Bed Dimensions, Standard of S. F. E. . . . .	148
Engine Forms of Airplanes . . . . .	141
Engine Installation in Airplanes . . . . .	143
Engines, Air and Water Cooled . . . . .	143
Engines, Pre-War, Characteristics of American Types . . . . .	150
Enlarged Wing Tips . . . . .	95
Equilibrium and Stability, Factors Regulating . . . . .	175
Evolution of Fuselage . . . . .	109
Examples of Atmospheric Force . . . . .	19
Expansion and Contraction of Gas . . . . .	29

## F

Fabric "Dope" . . . . .	86
Fabric for Wing Covering . . . . .	85
Factors and Influencing Power Needed . . . . .	138
Factors Regulating Equilibrium and Stability . . . . .	175
Factors Regulating Height of Landing Gear . . . . .	122
Fastening of Fabric . . . . .	87
First Aircraft to Navigate . . . . .	14
First Flights of Wright Brothers . . . . .	42
First Successful Heavier-than-Air Flight . . . . .	41
First Successful Long Airplane Flight . . . . .	41
Flexible Cable Ends . . . . .	105
Flight of Airplane, First Success . . . . .	41
Flight of Bird and Airplane Differ . . . . .	48
Flight Power Necessary . . . . .	42
Flying Boats, Curtiss Design . . . . .	231
Flying Hints, Important . . . . .	196
Flying in a Wind . . . . .	193

	PAGE
Flying Learned Only by Practice.....	195
Flying Machines, Three Classes of.....	18
Flying Machines, Value of Nature's and Man's.....	64
Force of Air in Motion.....	13
Foreign Airplane Designs.....	230
Forms of Airplane Engines.....	141
Forms of Airplane Fuselage.....	117
Forms of Airplane Wing.....	93
Forms of Landing Gear.....	120
Forms of Planes.....	43, 80
Four Forces Acting on Airplane in Flight.....	172
Free Balloons, Control of.....	31
Free Spherical Balloons, Military Value.....	31
Function of Ailerons.....	53
Fuselage, Advantages of.....	113
Fuselage, Construction of.....	118
Fuselage Construction of Airplanes.....	109
Fuselage Evolution.....	109
Fuselage Forms of Airplane.....	117
Fuselage Framework, Design of.....	113
Fuselage, Ideal Shape of.....	117
Fuselage, Modern Type of.....	118-119
Fuselage, Monocoque Type.....	117
Fuselage Ratio.....	117
Fuselage, Two-Seated Type of.....	118

## G

Galvanized Non-Flexible Ends.....	105
Gap, Effect of.....	77
Gap, Practical.....	79
Gap, Usual Spacing of.....	77
Gas as Lifting Power.....	28
Gauging Performance of Plane.....	56
Geared Down Propeller Drive.....	168
Gnome, Installation of.....	4, 151
Gravity, Attraction of.....	18
Gravity, Overcome for Airplane Flight.....	18
Greatest Lift by Upper Surface.....	75
Greatest Lifting Effort.....	24

## H

Hard Wire Loop.....	105
Heavier-than-Air Flight; First Success.....	41
Heavier-than-Air-Machines, Types of.....	16
Height of Landing Gear.....	122
Henson Airplane; Cause of Failure.....	39
High Angle of Incidence.....	71
High vs. Low Aspect Ratio.....	81

	PAGE
Horizontal Equivalents.....	98
Horse-Power, Defined.....	138
Horse-Power Required.....	138
How Airplanes Differ.....	24
How Coincidence of Centers is Obtained.....	119
How Fabric is Fastened.....	87
How Propellers are Balanced.....	167
How to Attain Altitude and Handle Machine.....	191
How to Take Off.....	191
Hydrogen Gas for Military Balloons.....	30
Hydrogen Gas, Lifting Power of.....	15
Hydrogen Gas vs. Coal Gas.....	30

## I

Illustrations of Wind-Power.....	19
Imitation of Birdflight Difficult.....	48
Importance of Complete Enclosure.....	118
Importance of Streamline Plane.....	60
Important Hints for Flying.....	196
Incidence, High Angle of.....	71
Incidence Wires.....	88
Increase Resistance with Augmenting Velocity.....	22
Influence of Lateral Dihedral.....	98
Insects, Square Feet Wing Area per Pound Weight.....	64
Inspecting Airplane before Flight.....	232
Aileron Inspection.....	238
Airplane before Flight, Inspecting of.....	232
Control Wires and Stabilizers.....	242
Fuselage Interior.....	240
Landing Gear Inspection.....	235
Nose Parts of Fuselage.....	236
Power-Plant Inspection.....	233
Propeller Inspection.....	232
Stabilizers and Control Wires.....	242
Struts and Wing Fittings.....	237
Wing Fittings and Struts.....	237
Installation of Anzani.....	151
Installation of Gnome.....	151
Installing Rotary and Radial Cylinder Engines.....	151
Instinctive Control.....	50
Instinct to Control Early Machines.....	50
Instruments for Navigating Airplanes.....	187
Interplane Bracing.....	91

## K

Kite Balloons Best for Observation Work.....	33
Kite Balloon, Method of Stabilizing.....	34
Kite Balloons, Military Value.....	34

	PAGE
Kite Balloon, Parts of .....	33
Kite Supported by Air in Motion.....	19
Kress's Experiments .....	41

## L

Lack of Speed a Drawback.....	42
Lanchester's Wing-Plan Forms.....	83
Landing.....	194
Landing Gear Construction and Bracing.....	108
Landing Gear Forms.....	120
Landing Gear, Height of.....	122
Landing Gears, Modern Types.....	123
Landing Gears, Pontoon Types of.....	126
Landing Precautions.....	193
Landing Wires.....	89
Langley's Machine.....	41
Lateral Dihedral, Influence of.....	98
Leading Edge of Plane.....	71
Leading Edge Should be Curved Down.....	60
"Levelling Off".....	194
Lift and Drift, Meaning of.....	56
Lift and Drift Values, Diagram of.....	57
Lift-Drift Ratio, Value of.....	57
Lift Greatest by Upper Surface.....	75
Lifting Effort, Greatest.....	24
Lifting Force of Plane, Cause.....	61
Lifting Power of Gas.....	28
Lifting Power of Hydrogen Gas.....	15
Lift Wires.....	89
Lighter-than-Air Craft.....	28
Lilienthal's Experiments.....	41
Linen Wing Covering.....	85
Loading of Bird's Wings.....	62
Loads on Airplane Wing Wires.....	91
Longitudinal Dihedral, Planes with.....	97
Long Lever vs. Short Lever Airplanes.....	177
Loop of Hard Wire.....	105

## M

Main Control Surfaces.....	48
Main Panels.....	205
Maintenance of Propeller.....	169
Make-up of Airplane.....	16
Make-up of Balloon.....	15
Making Turns, Control in.....	194
Manufacturing Practice of Propellers.....	160
Margin of Safety of Bracing Wires.....	91



	PAGE
Martin Side Bracing Design . . . . .	103
Mass of Material to Construct an Airplane . . . . .	134
Material to Construct an Airplane, Mass of . . . . .	134
Mathematical Consideration of Propeller Pitch . . . . .	155
Maxim's Flying Machine . . . . .	40
Maximum Efficiency, Position of . . . . .	73
Mean Effective Pitch . . . . .	155
Mean Experimental Pitch or Zero Thrust Pitch . . . . .	154
Meaning of Lift and Drift . . . . .	56
Metals, Strength of . . . . .	133
Metals Used in Airplanes . . . . .	131
Method of Stabilizing Kite Balloons . . . . .	34
Method of Sustaining Flight . . . . .	22
Military Balloons, Hydrogen Gas for . . . . .	30
Military Value of Blimp . . . . .	38
Military Value of Captive Spherical Balloons . . . . .	31
Military Value of Free Spherical Balloons . . . . .	31
Military Value of Kite Balloons . . . . .	34
Military Value of Zeppelin . . . . .	36
Miscellaneous Material, Strength of . . . . .	133
Modern Airplanes, Three of Curious Design . . . . .	95
Modern Fuselage from Shape of Fish . . . . .	117
Modern Fuselage Type . . . . .	118, 119
Modern Types of Landing Gears . . . . .	123
Monocoque Fuselage Type . . . . .	117
Monoplane or Biplane . . . . .	76
Monoplane vs. Biplane Bracing . . . . .	100
Monoplane Weakness . . . . .	76
Motors for Aircraft Must be Balanced . . . . .	137
Motors for Aircraft Must be Light . . . . .	137
Motors for Aircraft Must be Reliable . . . . .	136
Motors for Aircraft Nearest to Perfection . . . . .	136
Movement of Screw . . . . .	158
Multiplane, Philips . . . . .	40

## N

Navigating Airplanes, Instruments for . . . . .	187
Navigation of the Air . . . . .	13
Negative Lift vs. Positive Lift . . . . .	72
New Features of Airplane Construction . . . . .	42
Nomenclature of Standard Airplanes . . . . .	245
Non-Flexible Ends Galvanized . . . . .	105
Non-Rigid Type—Blimp . . . . .	36

## O

Observation Work, Kite Balloons Best for . . . . .	33
Operation of Airplane, Principle of . . . . .	17

	PAGE
Operation of Blimp in Air .....	38
Original Screw Propeller .....	152
Other Early Machines and Ader's .....	41

## P

Parasitic Resistance, Reduction of .....	115
Parts of Kite Balloon .....	33
Percentage of Total Load Carried .....	75
Perfect Liquid Air .....	154
Phillips Multiplane .....	40
Pitch of a Screw, Definition of .....	153
Pitch of Blade .....	156
Plane and Bird Flight Compared .....	47
Plane and Bird Form Compared .....	44
Plane Balancing Principles .....	50
Plane Forms .....	43, 80
Plane Forms, Early Ideas .....	77
Plane Forms, Theoretical and Actual .....	82
Plane Performance Gauged .....	56
Plane Proportions, The Best .....	43
Planes, Airplane Moves in .....	48
Plane's Aspect Ratio .....	43
Plane Sections, Fast and Slow .....	67
Planes Staggered .....	78
Planes with Longitudinal Dihedral .....	97
Pontoon Types of Landing Gears .....	126
Position of Center of Pressure .....	74
Position of Maximum Efficiency .....	73
Positive and Negative Stagger .....	79
Positive Lift vs. Negative Lift .....	72
Power Necessary for Flight .....	42
Power Necessary to Overcome Gravity .....	18
Power needed, Factors Influencing .....	138
Power-Plants for Airplanes .....	136
Power Required for Sustentation .....	24
Practical Gap .....	79
Practical Motor, Conditions for .....	138
Practical Variable Camber Wing .....	66
Practical Wing Forms .....	93
Precautions When Landing .....	193
Prehistoric Birds .....	63
Pressure Distribution on Aerofoils .....	71
Pressure Distribution, Securing Uniform .....	82
Principle of Dynamic Similarity .....	54
Principle of Operation of Airplane .....	17
Principle of Screw Propeller .....	153
Principles Observed in Designing Airplanes .....	114
Principles of Balancing Plane .....	50

	PAGE
Projections on Ailerons . . . . .	183
Propeller Construction and Action on Airplane . . . . .	152
Propeller Definitions . . . . .	158
Propeller Drive, Geared Down . . . . .	168
Propeller Maintenance . . . . .	169
Propeller Manufacturing Practice . . . . .	160
Propeller Pitch, Definition of . . . . .	153
Propeller Pitch, Mathematical Consideration of . . . . .	155
Propeller, Reduction Gear Drive for . . . . .	169
Propeller Thrust in Pounds Necessary . . . . .	140
Propeller Woods . . . . .	160
Properties of Cambered Aerofoils . . . . .	59
Propulsive Force of Airplane . . . . .	20
Pusher Biplane Type . . . . .	96

## R

Rapid Descent of Balloon Desired . . . . .	30
Ratio of Fuselage . . . . .	117
Reduction Gear Drive for Propeller . . . . .	169
Reduction of Parasitic Resistance . . . . .	115
Reserve Power Necessary to Secure Flights . . . . .	42
Resistance, Minimum of . . . . .	24
Resistance of Aerofoil Sections . . . . .	22
Resistance of Air . . . . .	21
Resistance, Reduction of Parasitic . . . . .	115
Retarding Forces to Flight . . . . .	18
Rib Camber . . . . .	84
Rigid Type—Zeppelin . . . . .	34
Rotary and Radial Cylinder Engines, Installation of . . . . .	151
Rotary Engines . . . . .	143
Rotary Motor, Installation of . . . . .	147
Rule Followed in Designing Propellers . . . . .	160
Run Motor Slowly to Warm It . . . . .	190

## S

Safety Margin of Bracing Wires . . . . .	91
Screw, Definition of . . . . .	152
Screw Movement . . . . .	158
Screw Propeller Action, Theories of . . . . .	157
Screw Propeller, Principle of . . . . .	153
Screw Working in Air . . . . .	154
Seaplanes, American Designs . . . . .	228
Securing Uniform Pressure Distribution . . . . .	82
Sense of Equilibrium Necessary for Control . . . . .	50
Setting Up of Airplane . . . . .	202
Aileron Adjustment . . . . .	217
Assembling Landing Gear to Fuselage . . . . .	202

	PAGE
Setting Up of Airplane, Checking Stagger .....	211
Dihedral Adjustment .....	208
Elevator Control Adjustment .....	218
Elevators .....	216
General Adjustment .....	219
Horizontal Stabilizer .....	214
Landing Gear .....	212
Landing Gear to Fuselage, Assembly of .....	202
Panel Assembly .....	204
Rudder .....	217
Rudder Control Adjustment .....	217
Tail Assembly .....	212
Three Methods of Checking Dihedral .....	210
Vertical Stabilizer .....	215
Wings and Fuselage, Checking Alignment of .....	220
Shape of Ideal Fuselage .....	117
Short Lever <i>vs.</i> Long Lever Airplanes .....	177
Side Bracing of Airplane Wings .....	102
Sizes and Strength of Cables .....	105
Sizes and Strength of Wires .....	105
Small Control Surfaces, Why So Effective .....	177
Sopwith Triplane .....	225
Spherical Balloon Parts .....	28
Spinning Nose Dive or Tail Spin .....	195
Stabilizing Method of Kite Balloons .....	34
Staggered Planes .....	78
Stagger, Effect of .....	79
Stagger, Positive and Negative .....	79
Stalling, Danger in .....	193
Stalling or Zooming .....	191
Standard Airplanes, Nomenclature of .....	245
Standard Control Systems of To-day .....	181
Standard S. A. E. Engine Bed Dimensions .....	148
Starting Engine with Screw .....	155
Starting System of Early Wright .....	111
Stick Control System .....	182
Streamline Body, Definition of .....	115
Streamline Plane Important .....	60
Strength and Efficiency of Wing Sections .....	66
Strength and Sizes of Wires .....	105
Strength of Miscellaneous Material .....	133
Strength of Various Metals .....	133
Strength of Various Woods .....	132
Strength of Wing Covering .....	85
Student in Flying, Suggestions for .....	188
Suggestions for the Student in Flying .....	188
Supporting Surfaces Determined .....	54
Support of Airplane in Air .....	16
Sustaining Effort, Varying the Degree of .....	20

	PAGE
Sustaining Flight, Method of . . . . .	22
Sustentation, Power Required for . . . . .	24

## T

Tail Spin or Spinning Nose Dive . . . . .	195
Take Off, How to . . . . .	191
Taube Wing Plan . . . . .	83
The Function of Balanced Control . . . . .	183
Theoretical and Actual Plane Forms . . . . .	82
Theories of Screw Propeller Action . . . . .	157
Theory of the Blade . . . . .	158
Theory of the Disc . . . . .	157
Thimbles . . . . .	106
Thimbles and Turnbuckles, Details of . . . . .	104
Three Axes of Airplane in Flight . . . . .	171
Three Classes of Flying Machines . . . . .	18
Three Modern Airplanes of Curious Design . . . . .	95
Thrust in Pounds Necessary . . . . .	140
Total Load Carried, Percentage of . . . . .	75
Transverse Strength of Wooden Bars . . . . .	134
Turnbuckles . . . . .	106
Turnbuckles and Thimbles, Details of . . . . .	104
Turning, Control in . . . . .	194
Turning in the Air . . . . .	192
Two-Seated Fuselage Type . . . . .	118
Types of Aircraft . . . . .	13
Types of Airplanes, Three Main . . . . .	27
Types of Dirigibles . . . . .	15
Types of Heavier-than-Air Machines . . . . .	16
Typical Airplanes in Practical Use . . . . .	223
Typical Airplane Wing . . . . .	85
Typical Biplane View . . . . .	92
Typical Wing Structure Bracing . . . . .	101
Typical Wire Bracing Arrangements . . . . .	107

## U

Uncrating a Curtiss JN4 . . . . .	198
Examination of Parts before Assembly . . . . .	198
How Parts are Packed . . . . .	198
How to Unpack a Curtiss Biplane . . . . .	198
Uncrating, Setting-Up and Aligning Airplane . . . . .	198
Upper Surface, Greatest Lift by . . . . .	75
Use of Vertical Rudder . . . . .	52
Use of Wing Flaps . . . . .	53
Usual Spacing of Gap . . . . .	77

## V

	PAGE
Value of Lift-Drift Ratio.....	57
Value of Nature's and Man's Flying Machines.....	64
Variable Camber Wing, Practical.....	66
Variation in Air-Pressure.....	176
Various Velocities, Wind-Pressure at.....	23
Varnishing Wings.....	87
Varying Lower Camber, Effect of.....	70
Vertical Lift of Plane.....	60
Vertical Rudder Use.....	52
View of Typical Biplane.....	92

## W

Warm Air, Ascensional Power of.....	14
Warming up Motor.....	190
Wash-in and Wash-out.....	212
Water-Cooled Engines.....	143
Weakness of Monoplane.....	77
Weight and Flying-Power of Birds.....	63
Weight as Measure of Mass.....	18
Wheel Tread Depends on Spread.....	122
When Screw Works in Air.....	154
Why "Dope" is Used for Wings.....	86
Why Small Control Surfaces are so Effective.....	177
Why the Airplane is Banked in Turning.....	183
Why the Airplane is Best.....	17
Width of Advancing Edge.....	43
Wind.....	49
Wind Flying.....	193
Wind Power Illustrations.....	19
Wind Pressure at Various Velocities.....	23
Wind Assembly of Braced Biplane.....	89
Wind Bracing on Airplanes.....	100
Wing Camber of Bird.....	71
Wing Construction of Airplane.....	84
Wing Covering Fabric.....	85
Wing Covering Strength.....	85
Wing "Dope".....	86
Wing Flap Use.....	53
Wing Form of Airplane.....	93
Wing Forms, Practical Design of.....	93
Wing Loading, Effect on Aerofoil Design of.....	65
Wing Plan Forms of Lanchester.....	83
Wing Plan of Taube.....	83
Wings: Arrangement, Construction and Bracing.....	76
Wing Sections, Deep and Shallow.....	65
Wing Sections, Strength and Efficiency of.....	66

	PAGE
Wing Sections Vary in Design.....	66
Wing Span, Efficient.....	81
Wing Thickness—Best Camber.....	70
Wing Tips Enlarged.....	95
Wing Wires, Loads on.....	91
Wire Bracing, Typical Arrangements of.....	107
Wires for Incidence.....	88
Wires for Landing.....	88
Wires for Lift.....	89
Wires, Sizes and Strength of.....	105
Wooden Bars, Transverse Strength of.....	134
Woods for Airplane Parts.....	126
Woods for Propellers.....	160
Woods, Strengths of.....	132
Work, Definition of.....	138
Wright Brothers' Experiments.....	41
Wright Brothers' First Flights.....	109
Wright Creation.....	42
Wright vs. Curtiss Design, Early.....	110

## Z

Zeppelin, Dirigible Balloon Types.....	34
Zeppelin, Its Construction.....	34
Zeppelin, Military Value of.....	36
Zero or Thrust Pitch.....	154
Zooming or Stalling.....	191

# CATALOGUE

*Of the LATEST and BEST*

## PRACTICAL *and* MECHANICAL BOOKS

*Including Automobile and Aviation Books*



*Any of these books will be sent prepaid to any part of the world,  
on receipt of price. Remit by Draft, Postal Order, Express  
Order or Registered Letter*

---

Published and For Sale By

**The Norman W. Henley Publishing Co.,**

2 West 45th Street, New York, U.S.A.



INDEX

	PAGES		PAGES
Air Brakes.....	21, 24	Link Motions.....	22
Arithmetic.....	14, 25, 31	Liquid Air.....	21
Automobile Books.....	3, 4, 5, 6	Locomotive Boilers.....	22
Automobile Charts.....	6, 7	Locomotive Breakdowns.....	22
Automobile Ignition Systems.....	5	Locomotive Engineering.....	21, 22, 23, 24
Automobile Lighting.....	5	Machinist Book.....	24, 25, 26
Automobile Questions and Answers.....	4	Magazine, Mechanical.....	34
Automobile Repairing.....	4	Manual Training.....	26
Automobile Starting Systems.....	5	Marine Engineering.....	26
Automobile Trouble Charts.....	5, 6	Marine Gasoline Engines.....	19
Automobile Welding.....	5	Mechanical Drawing.....	13, 14
Aviation.....	7	Mechanical Magazine.....	34
Aviation Chart.....	7	Mechanical Movements.....	25
Batteries, Storage.....	5	Metal Work.....	12, 13
Bevel Gear.....	19	Motorcycles.....	5, 6
Boiler-Room Chart.....	9	Patents.....	20
Brazing.....	7	Pattern Making.....	27
Cams.....	19	Perfumery.....	27
Carburetion Trouble Chart.....	6	Perspective.....	13
Change Gear.....	19	Plumbing.....	28, 29
Charts.....	6, 7, 8	Producer Gas.....	19
Coal.....	22	Punches.....	13
Coke.....	9	Questions and Answers on Automobile.....	4
Combustion.....	22	Questions on Heating.....	32
Compressed Air.....	10	Railroad Accidents.....	23
Concrete.....	10, 11, 12	Railroad Charts.....	9
Concrete for Farm Use.....	11	Recipe Book.....	29
Concrete for Shop Use.....	11	Refrigeration.....	20
Cosmetics.....	27	Repairing Automobiles.....	4
Cyclecars.....	5	Rope Work.....	20
Dictionary.....	12	Rubber.....	30
Dies.....	12, 13	Rubber Stamps.....	30
Drawing.....	13, 14	Saw Filing.....	30
Drawing for Plumbers.....	28	Saws, Management of.....	30
Drop Forging.....	13	Sheet-Metal Works.....	12, 13
Dynamo Building.....	14	Shop Construction.....	25
Electric Bells.....	14	Shop Management.....	25
Electric Switchboards.....	14, 16	Shop Practice.....	25
Electric Toy Making.....	15	Shop Tools.....	25
Electric Wiring.....	14, 15, 16	Sketching Paper.....	14
Electricity.....	14, 15, 16, 17	Soldering.....	7
Encyclopedia.....	24	Splices and Rope Work.....	20
E-T Air Brake.....	24	Steam Engineering.....	30, 31
Every-day Engineering.....	34	Steam Heating.....	31, 32
Factory Management.....	17	Steel.....	32
Ford Automobile.....	3	Storage Batteries.....	5
Ford Trouble Chart.....	6	Submarine Chart.....	9
Formulas and Recipes.....	29	Switchboards.....	14, 16
Fuel.....	17	Tapers.....	21
Gas Construction.....	18	Telegraphy, Wireless.....	17
Gas Engines.....	18, 19	Telephone.....	16
Gas Tractor.....	33	Thread Cutting.....	26
Gearing and Cams.....	19	Tool Making.....	24
Glossary of Aviation Terms.....	7, 12	Toy Making.....	15
Heating.....	31, 32	Train Rules.....	23
Horse-Power Chart.....	9	Tractive Power Chart.....	9
Hot-Water Heating.....	31, 32	Tractor, Gas.....	33
House Wiring.....	15, 17	Turbines.....	33
How to Run an Automobile.....	3	Vacuum Heating.....	32
Hydraulics.....	5	Valve Setting.....	22
Ice and Refrigeration.....	20	Ventilation.....	31
Ignition Systems.....	5	Watch Making.....	33
Ignition-Trouble Chart.....	6	Waterproofing.....	12
India Rubber.....	30	Welding with Oxy-acetylene Flame.....	5, 33
Interchangeable Manufacturing.....	24	Wireless Telegraphy.....	17
Inventions.....	20	Wiring.....	14, 15
Knots.....	20	Wiring Diagrams.....	14
Lathe Work.....	20		

Any of these books promptly sent prepaid to any address in the world on receipt of price.

**HOW TO REMIT**—By Postal Money Order, Express Money Order, Bank Draft or Registered Letter.

**AUTOMOBILES AND MOTORCYCLES**

**The Modern Gasoline Automobile—Its Design, Construction, and Operation, 1918 Edition.** By VICTOR W. PAGÉ, M.S.A.E.

This is the most complete, practical and up-to-date treatise on gasoline automobiles and their component parts ever published. In the new revised and enlarged 1918 edition, all phases of automobile construction, operation and maintenance are fully and completely described, and in language anyone can understand. Every part of all types of automobiles, from light cycle-cars to heavy motor trucks and tractors, are described in a thorough manner, not only the automobile, but every item of it; equipment, accessories, tools needed, supplies and spare parts necessary for its upkeep, are fully discussed.

*It is clearly and concisely written by an expert familiar with every branch of the automobile industry and the originator of the practical system of self-education on technical subjects. It is a liberal education in the automobile art, useful to all who motor for either business or pleasure.*

Anyone reading the incomparable treatise is in touch with all improvements that have been made in motor-car construction. All latest developments, such as high speed aluminum motors and multiple valve and sleeve-valve engines, are considered in detail. The latest ignition, carburetor and lubrication practice is outlined. New forms of change speed gears, and final power transmission systems, and all latest chassis improvements are shown and described. This book is used in all leading automobile schools and is conceded to be the STANDARD TREATISE. The chapter on Starting and Lighting Systems has been greatly enlarged, and many automobile engineering features that have long puzzled laymen are explained so clearly that the underlying principles can be understood by anyone. This book was first published six years ago and so much new matter has been added that it is nearly twice its original size. The only treatise covering various forms of war automobiles and recent developments in motor-truck design as well as pleasure cars. *This book is not too technical for the layman nor too elementary for the more expert. It is an incomparable work of reference for home or school.* 1,000 6x9 pages, nearly 1,000 illustrations, 12 folding plates. Cloth bound. Price . . . . . **\$3.00**

**WHAT IS SAID OF THIS BOOK:**

"It is the best book on the Automobile seen up to date."—J. H. Pile, Associate Editor *Automobile Trade Journal*.

"Every Automobile Owner has use for a book of this character."—*The Tradesman*.

"This book is superior to any treatise heretofore published on the subject."—*The Inventive Age*.

"We know of no other volume that is so complete in all its departments, and in which the wide field of automobile construction with its mechanical intricacies is so plainly handled, both in the text and in the matter of illustrations."—*The Motorist*.

"The book is very thorough, a careful examination failing to disclose any point in connection with the automobile, its care and repair, to have been overlooked."—*Iron Age*.

"Mr. Pagé has done a great work, and benefit to the Automobile Field."—W. C. Hasford, Mar. Y. M. C. A. Automobile School, Boston, Mass.

"It is just the kind of a book a motorist needs if he wants to understand his car."—*American Thresherman*.

**The Model T Ford Car, Its Construction, Operation and Repair.** By VICTOR W. PAGÉ, M.S.A.E.

This is a complete instruction book. All parts of the Ford Model T Car are described and illustrated; the construction is fully described and operating principles made clear to everyone. Every Ford owner needs this practical book. You don't have to guess about the construction or where the trouble is, as it shows how to take all parts apart and how to locate and fix all faults. The writer, Mr. Pagé, has operated a Ford car for many years and writes from actual knowledge. Among the contents are: 1. The Ford Car: Its Parts and Their Functions. 2. The Engine and Auxiliary Groups. How the Engine Works—The Fuel Supply System—The Carburetor—Making the Ignition Spark—Cooling and Lubrication. 3. Details of Chassis. Change Speed Gear—Power Transmission—Differential Gear Action—Steering Gear—Front Axle—Frame and Springs—Brakes. 4. How to Drive and Care for the Ford. The Control System Explained—Starting the Motor—Driving the Car—Locating Roadside Troubles—Tire Repairs—Oiling the Chassis—Winter Care of Car. 5. Systematic Location of Troubles and Remedies. Faults in Engine—Faults in Carburetor—Ignition Troubles—Cooling and Lubrication System Defects—Adjustment of Transmission Gear—General Chassis Repairs. 95 illustrations, 300 pages, 2 large folding plates. Price . . . . . **\$1.00**

**How to Run an Automobile.** By VICTOR W. PAGÉ, M.S.A.E.

This treatise gives concise instructions for starting and running all makes of gasoline automobiles, how to care for them, and gives distinctive features of control. Describes every step for shifting gears, controlling engines, etc. Among the chapters contained are: I.—Automobile Parts and Their Functions. II.—General Starting and Driving Instructions. III.—Typical 1917 Control Systems. IV.—Care of Automobiles. 178 pages. 72 specially made illustrations. Price **\$1.00**

**Automobile Repairing Made Easy.** By VICTOR W. PAGÉ, M.S.A.E.

A comprehensive, practical exposition of every phase of modern automobile repairing practice. Outlines every process incidental to motor car restoration. (Gives plans for workshop construction, suggestions for equipment, power needed, machinery and tools necessary to carry on business successfully. Tells how to overhaul and repair all parts of all automobiles. Everything is explained so simply that motorists and students can acquire a full working knowledge of automobile repairing. This work starts with the engine, then considers carburetion, ignition, cooling and lubrication systems. The clutch, change speed gearing and transmission system are considered in detail. Contains instructions for repairing all types of axles, steering gears and other chassis parts. Many tables, short cuts in figuring and rules of practice are given for the mechanic. Explains fully valve and magnet timing, "tuning" engines, systematic location of trouble, repair of ball and roller bearings, shop kinks, first aid to injured and a multitude of subjects of interest to all in the garage and repair business. This book contains special instructions on electric starting, lighting and ignition systems, tire repairing and rebuilding, autogenous welding, brazing and soldering, heat treatment of steel, latest timing practice, eight and twelve-cylinder motors, etc. 5 $\frac{1}{2}$ x8. Cloth. 1,056 pages, 1,000 illustrations, 11 folding plates. Price **\$3.60**

## WHAT IS SAID OF THIS BOOK:

"Automobile Repairing Made Easy" is the best book on the subject I have ever seen and the only book I ever saw that is of any value in a garage."—Fred Jeffrey, Martinsburg, Neb. "I wish to thank you for sending me a copy of 'Automobile Repairing Made Easy'. I do not think it could be excelled."—S. W. Gasriel, Director of Instruction, Y. M. C. A., Philadelphia, Pa.

**Questions and Answers Relating to Modern Automobile Construction, Driving and Repair.** By VICTOR W. PAGÉ, M.S.A.E.

A practical self-instructor for students, mechanics and motorists, consisting of thirty-seven lessons in the form of questions and answers, written with special reference to the requirements of the non-technical reader desiring easily understood explanatory matter relating to all branches of automobilism. The subject-matter is absolutely correct and explained in simple language. If you can't answer all of the following questions, you need this work. The answers to these and over 2,000 more are to be found in its pages. Give the name of all important parts of an automobile and describe their functions. Describe action of latest types of kerosene carburetors. What is the difference between a "double" ignition system and a "dual" ignition system? Name parts of an induction coil. How are valves timed? What is an electric motor starter and how does it work? What are advantages of worm drive gearing? Name all important types of ball and roller bearings. What is a "three-quarter" floating axle? What is a two-speed axle? What is the Vulcan electric gear shift? Name the causes of lost power in automobiles. Describe all noises due to deranged mechanism and give causes. How can you adjust a carburetor by the color of the exhaust gases? What causes "popping" in the carburetor? What tools and supplies are needed to equip a car? How do you drive various makes of cars? What is a differential lock and where is it used? Name different systems of wire wheel construction, etc., etc. A popular work at a popular price. 5 $\frac{1}{2}$ x7 $\frac{1}{2}$ . Cloth. 650 pages, 350 illustrations, 3 folding plates. Price **\$1.50**

## WHAT IS SAID OF THIS BOOK:

"If you own a car—get this book."—*The Glassworker*.  
 "Mr. Page has the faculty of making difficult subjects plain and understandable."—*Bristol Press*.  
 "We can name no writer better qualified to prepare a book of instruction on automobiles than Mr. Victor W. Pagé."—*Scientific American*.  
 "The best automobile catechism that has appeared."—*Automobile Topics*.  
 "There are few men, even with long experience, who will not find this book useful. Great pains have been taken to make it accurate. Special recommendation must be given to the illustrations, which have been made specially for the work. Such excellent books as this greatly assist in fully understanding your automobile."—*Engineering News*.

**The Automoblist's Pocket Companion and Expense Record.** Arranged by VICTOR W. PAGÉ, M.S.A.E.

This book is not only valuable as a convenient cost record but contains much information of value to motorists. Includes a condensed digest of auto laws of all States, a lubrication schedule, hints for care of storage battery and care of tires, location of road troubles, anti-freezing solutions, horse-power table, driving hints and many useful tables and recipes of interest to all motorists. Not a technical book in any sense of the word, just a collection of practical facts in simple language for the everyday motorist. Price **\$1.00**

**Modern Starting, Lighting and Ignition Systems.** By VICTOR W. PAGE, M.E.

This practical volume has been written with special reference to the requirements of the non-technical reader desiring easily understood, explanatory matter, relating to all types of automobile ignition, starting and lighting systems. It can be understood by anyone, even without electrical knowledge, because elementary electrical principles are considered before any attempt is made to discuss features of the various systems. These basic principles are clearly stated and illustrated with simple diagrams. All the leading systems of starting, lighting and ignition have been described and illustrated with the co-operation of the experts employed by the manufacturers. Wiring diagrams are shown in both technical and non-technical forms. All symbols are fully explained. It is a comprehensive review of modern starting and ignition system practice, and includes a complete exposition of storage battery construction, care and repair. All types of starting motors, generators, magnetos, and all ignition or lighting systems units are fully explained. *Every person in the automobile business needs this volume.* Among some of the subjects treated are: I.—Elementary Electricity; Current Production; Flow; Circuits; Measurements; Definitions; Magnetism; Battery Action; Generator Action. II.—Battery Ignition Systems. III.—Magneto Ignition Systems. IV.—Elementary Exposition of Starting System Principles. V.—Typical Starting and Lighting Systems; Practical Application; Wiring Diagrams; Auto-lite, Bijur, Delco, Dyneto, Enta, Gray and Davis, Remy, U. S. L., Westinghouse, Bosch-Rushmore; Genemotor, North-East, etc. VI.—Locating and Repairing Troubles in Starting and Lighting Systems. VII.—Auxiliary Electric Systems; Gear-shifting by Electricity; Warning Signals; Electric Brake; Enta-Transmission, Wagner-Saxon Circuits, Wagner-Studebaker Circuits. 5¼x7½. Cloth. 530 pages, 297 illustrations, 3 folding plates. Price **\$1.50**

**Automobile Welding With the Oxy-Acetylene Flame.** By M. KEITH DUNHAM.

This is the only complete book on the "why" and "how" of Welding with the Oxy-Acetylene Flame, and from its pages one can gain information so that he can weld anything that comes along.

No one can afford to be without this concise book, as it first explains the apparatus to be used, and then covers in detail the actual welding of all automobile parts. The welding of aluminum, cast iron, steel, copper, brass and malleable iron is clearly explained, as well as the proper way to burn the carbon out of the combustion head of the motor. Among the contents are: Chapter I.—Apparatus Knowledge. Chapter II.—Shop Equipment and Initial Procedure. Chapter III.—Cast Iron. Chapter IV.—Aluminum. Chapter V.—Steel. Chapter VI.—Malleable Iron, Copper, Brass, Bronze. Chapter VII.—Carbon Welding and other Uses of Oxygen and Acetylene. Chapter VIII.—How to Figure Cost of Welding. 167 pages, fully illustrated. Price **\$1.00**

**Storage Batteries Simplified.** By VICTOR W. PAGE, M.S.A.E.

A comprehensive treatise devoted entirely to secondary batteries and their maintenance, repair and use.

This is the most up-to-date book on this subject. Describes fully the Exide, Edison, Gould, Willard, U. S. L. and other storage battery forms in the types best suited for automobile, stationary and marine work. Nothing of importance has been omitted that the reader should know about the practical operation and care of storage batteries. No details have been slighted. The instructions for charging and care have been made as simple as possible. Brief Synopsis of Chapters: Chapter I.—Storage Battery Development; Types of Storage Batteries; Lead Plate Types; The Edison Cell. Chapter II.—Storage Battery Construction; Plates and Grids; Plated Plates; Fauré Plates; Non-Lead Plates; Commercial Battery Designs. Chapter III.—Charging Methods; Rectifiers; Converters; Rheostats; Ropes for Charging. Chapter IV.—Battery Repairs and Maintenance. Chapter V.—Industrial Application of Storage Batteries; Glossary of Storage Battery Terms. 206 Pages. Very Fully Illustrated. Price **\$1.50 net.**

**Motorcycles, Side Cars and Cyclecars; their Construction, Management and Repair.** By VICTOR W. PAGE, M.S.A.E.

The only complete work published for the motorcyclist and cyclecarist. Describes fully all leading types of machines, their design, construction, maintenance, operation and repair. This treatise outlines fully the operation of two- and four-cycle power plants and all ignition, carburetion and lubrication systems in detail. Describes all representative types of free engine clutches, variable speed gears and power transmission systems. Gives complete instructions for operating and repairing all types. Considers fully electric self-starting and lighting systems, all types of spring frames and spring forks and shows leading control methods. For those desiring technical information a complete series of tables and many formulae to assist in designing are included. The work tells how to figure power needed to climb grades, overcome air resistance and attain high speeds. It shows how to select gear ratios for various weights and powers, how to figure braking efficiency required, gives sizes of belts and chains to transmit power safely, and shows how to design sprockets, belt pulleys, etc. This work also includes complete formulae for figuring horse-power, shows how dynamometer tests are

made, defines relative efficiency of air and water-cooled engines, plain and anti-friction bearings and many other data of a practical, helpful, engineering nature. Remember that you get this information in addition to the practical description and instructions which alone are worth several times the price of the book. 550 pages. 350 specially made illustrations, 5 folding plates. Cloth. Price . . . . . **\$1.50**

**WHAT IS SAID OF THIS BOOK:**

"Here is a book that should be in the cycle repairer's kit."—*American Blacksmith*.  
 "The best way for any rider to thoroughly understand his machine, is to get a copy of this book; it is worth many times its price."—*Pacific Motorcyclist*.

**AUTOMOBILE AND MOTORCYCLE CHARTS**

**Chart. Location of Gasoline Engine Troubles Made Easy—A Chart Showing Sectional View of Gasoline Engine.** Compiled by VICTOR W. PAGÉ, M.S.A.E.

It shows clearly all parts of a typical four-cylinder gasoline engine of the four-cycle type. It outlines distinctly all parts liable to give trouble and also details the derangements apt to interfere with smooth engine operation. Valuable to students, motorists, mechanics, repairmen, garagemen, automobile salesmen, chauffeurs, motorboat owners, motor-truck and tractor drivers, aviators, motor-cyclists, and all others who have to do with gasoline power plants. It simplifies location of all engine troubles, and while it will prove invaluable to the novice, it can be used to advantage by the more expert. It should be on the walls of every public and private garage, automobile repair shop, club house or school. It can be carried in the automobile or pocket with ease, and will insure against loss of time when engine trouble manifests itself. This sectional view of engine is a complete review of all motor troubles. It is prepared by a practical motorist for all who motor. More information for the money than ever before offered. No details omitted. Size 25x38 inches. Securely mailed on receipt of **25 cents**

**Chart. Location of Ford Engine Troubles Made Easy.** Compiled by VICTOR W. PAGÉ, M.S.A.E.

This shows clear sectional views depicting all portions of the Ford power plant and auxiliary groups. It outlines clearly all parts of the engine, fuel supply system, ignition group and cooling system, that are apt to give trouble, detailing all derangements that are liable to make an engine lose power, start hard or work irregularly. This chart is valuable to students, owners, and drivers, as it simplifies location of all engine faults. Of great advantage as an instructor for the novice, it can be used equally well by the more expert as a work of reference and review. It can be carried in the tool-box or pocket with ease and will save its cost in labor eliminated the first time engine trouble manifests itself. Prepared with special reference to the average man's needs and is a practical review of all motor troubles because it is based on the actual experience of an automobile engineer-mechanic with the mechanism the chart describes. It enables the non-technical owner or operator of a Ford car to locate engine derangements by systematic search, guided by easily recognized symptoms instead of by guesswork. It makes the average owner independent of the roadside repair shop when touring. Must be seen to be appreciated. Size 25x38 inches. Printed on heavy bond paper. Price . . . . . **25 cents**

**Chart. Lubrication of the Motor Car Chassis.** Compiled by VICTOR W. PAGÉ, M.S.A.E.

This chart presents the plan view of a typical six-cylinder chassis of standard design and all parts are clearly indicated that demand oil, also the frequency with which they must be lubricated and the kind of oil to use. A practical chart for all interested in motor-car maintenance. Size 24x38 inches. Price . . . . . **25 cents**

**Chart. Location of Carbureton Troubles Made Easy.** Compiled by VICTOR W. PAGÉ, M.S.A.E.

This chart shows all parts of a typical pressure feed fuel supply system and gives causes of trouble, how to locate defects and means of remedying them. Size 24x38 inches. Price . . . . . **25 cents**

**Chart. Location of Ignition System Troubles Made Easy.** Compiled by VICTOR W. PAGÉ, M.S.A.E.

In this diagram all parts of a typical double ignition system using battery and magneto current are shown, and suggestions are given for readily finding ignition troubles and eliminating them when found. Size 24x38 inches. Price . . . . . **25 cents**

**Chart. Location of Cooling and Lubrication System Faults.** Compiled by VICTOR W. PAGÉ, M.S.A.E.

This composite diagram shows a typical automobile power plant using pump circulated water-cooling system and the most popular lubrication method. Gives suggestions for curing all overheating and loss of power faults due to faulty action of the oiling or cooling group. Size 24x38 inches. Price . . . . . **25 cents**

**Chart. Motorcycle Troubles Made Easy.** Compiled by VICTOR W. PAGÉ, M.S.A.E.

A chart showing sectional view of a single-cylinder gasoline engine. This chart simplifies location of all power-plant troubles. A single-cylinder motor is shown for simplicity. It outlines distinctly all parts liable to give trouble and also details the derangements apt to interfere with smooth engine operation. This chart will prove of value to all who have to do with the operation, repair or sale of motorcycles. No details omitted. Size 30x20 inches. Price . . . . . **25 cents**

**AVIATION**

**Aviation Engines, their Design, Construction, Operation and Repair.** By Lieut. VICTOR W. PAGÉ, Aviation Section, S.C.U.S.R.

A practical work containing valuable instructions for aviation students, mechanics, squadron engineering officers and all interested in the construction and upkeep of airplane power plants.

The rapidly increasing interest in the study of aviation, and especially of the highly developed internal combustion engines that make mechanical flight possible, has created a demand for a text-book suitable for schools and home study that will clearly and concisely explain the workings of the various aircraft engines of foreign and domestic manufacture.

This treatise, written by a recognised authority on all of the practical aspects of internal combustion engine construction, maintenance and repair fills the need as no other book does. The matter is logically arranged; all descriptive matter is simply expressed and copiously illustrated so that anyone can understand airplane engine operation and repair even if without previous mechanical training. This work is invaluable for anyone desiring to become an aviator or aviation mechanic.

The latest rotary types, such as the Gnome, Monosoupape, and Le Rhone, are fully explained, as well as the recently developed Vee and radial types. The subjects of carburetion, ignition, cooling and lubrication also are covered in a thorough manner. The chapters on repair and maintenance are distinctive and found in no other book on this subject.

Invaluable to the student, mechanic and soldier wishing to enter the aviation service. Not a technical book, but a practical, easily understood work of reference for all interested in aeronautical science. 576 octavo pages. 253 specially made engravings. Price . **\$3.00 net**

**GLOSSARY OF AVIATION TERMS**

**Termes D'Aviation, English-French, French-English.** Compiled by Lieuts. VICTOR W. PAGÉ, A.S., S.C.U.S.R., and PAUL MONTARIOL of the French Flying Corps, on duty on Signal Corps Aviation School, Mineola, L. I.

A complete, well illustrated volume intended to facilitate conversation between English-speaking and French aviators. A very valuable book for all who are about to leave for duty overseas.

Approved for publication by Major W. G. Kilner, S.C., U.S.C.O. Signal Corps Aviation School. Haslehurst Field, Mineola, L. I.

This book should be in every Aviator's and Mechanic's Kit for ready reference. 128 pages. Fully illustrated with detailed engravings. Price . . . . . **\$1.00**

**Aviation Chart. Location of Airplane Power Plant Troubles Made Easy.** By Lieut. VICTOR W. PAGÉ, A.S., S.C.U.S.R.

A large chart outlining all parts of a typical airplane power plant, showing the points where trouble is apt to occur and suggesting remedies for the common defects. Intended especially for Aviators and Aviation Mechanics on School and Field Duty. Price . . **50 cents**

**BRAZING AND SOLDERING**

**Brazing and Soldering.** By JAMES F. HOBART.

The only book that shows you just how to handle any job of brazing or soldering that comes along; it tells you what mixture to use, how to make a furnace if you need one. Full of valuable kinks. The fifth edition of this book has just been published, and to it much new matter and a large number of tested formulae for all kinds of solders and fluxes have been added. Illustrated. Price . . . . . **25 cents**

**CHARTS**

**Aviation Chart. Location of Airplane Power Plant Troubles Made Easy.**  
By Lieut. VICTOR W. PAGE, A.S., S.C.U.S.R.

A large chart outlining all parts of a typical airplane power plant, showing the points where trouble is apt to occur and suggesting remedies for the common defects. Intended especially for Aviators and Aviation Mechanics on School and Field Duty. Price **50 cents**

**Gasoline Engine Troubles Made Easy—A Chart Showing Sectional View of Gasoline Engine:** Compiled by Lieut. VICTOR W. PAGE, A.S., S.C.U.S.R.

It shows clearly all parts of a typical four-cylinder gasoline engine of the four-cycle type. It outlines distinctly all parts liable to give trouble and also details the derangements apt to interfere with smooth engine operation. Valuable to students, motorists, mechanics, repairmen, garagemen, automobile salesmen, chauffeurs, motor-boat owners, motor-truck and tractor drivers, aviators, motor-cyclists, and all others who have to do with gasoline power plants. It simplifies location of all engine troubles, and while it will prove invaluable to the novice, it can be used to advantage by the more expert. It should be on the walls of every public and private garage, automobile repair shop, club house or school. It can be carried in the automobile or pocket with ease and will insure against loss of time when engine trouble manifests itself.

This sectional view of engine is a complete review of all motor troubles. It is prepared by a practical motorist for all who motor. No details omitted. Size 25x38 inches. Price **25 cents**

**Lubrication of the Motor Car Chassis.**

This chart presents the plan view of a typical six-cylinder chassis of standard design and all parts are clearly indicated that demand oil, also the frequency with which they must be lubricated and the kind of oil to use. A practical chart for all interested in motor-car maintenance. Size 24x38 inches. Price **25 cents**

**Location of Carburettion Troubles Made Easy**

This chart shows all parts of a typical pressure feed fuel supply system and gives causes of trouble, how to locate defects and means of remedying them. Size 24x38 inches. Price **25 cents**

**Location of Ignition System Troubles Made Easy**

In this chart all parts of a typical double ignition system (battery and magneto) current are shown and suggestions are given for readily finding ignition troubles and eradicating them when found. Size 24x38 inches. Price **25 cents**

**Location of Cooling and Lubrication System Faults.**

This composite chart shows a typical automobile power plant using pump circulated water-cooling system and the most common lubrication system. It gives methods of locating overheating and loss of power faults due to faulty action of the cooling or oiling groups. Size 24x38 inches. Price **25 cents**

**Motorcycle Troubles Made Easy—A Chart Showing Sectional View of Single-Cylinder Gasoline Engine.** Compiled by VICTOR W. PAGE, M.S.A.E.

This chart simplifies location of all power-plant troubles and will prove invaluable to all who have to do with the operation or sale of motorcycles. No details omitted. Size 25x38 inches. Price **25 cents**

**Location of Ford Engine Troubles Made Easy.** Compiled by Victor W. PAGE, M.S.A.E.

This shows clear sectional views depicting all portions of the Ford power plant and auxiliary groups. It outlines clearly all parts of the engine, fuel supply system, ignition group and cooling system, that are apt to give trouble, detailing all derangements that are liable to make an engine lose power, start hard or work irregularly. This chart is valuable to students, owners, and drivers, as it simplifies location of all engine faults. Of great advantage as an instructor for the novice, it can be used equally well by the more expert as a work of reference and review. It can be carried in the toolbox or pocket with ease and will save its cost in labor eliminated the first time engine trouble manifests itself. Prepared with special reference to the average man's needs and is a practical review of all motor troubles because it is based on the actual experience of an automobile engineer-mechanic with the mechanism the chart describes. It enables the non-technical owner or operator of a Ford car to locate engine derangements by systematic search, guided by easily recognized symptoms instead of by guesswork. It makes the average owner independent of the roadside repair shop when touring. Must be seen to be appreciated. Size 25x38 inches. Printed on heavy bond paper. Price **25 cents**

**Modern Submarine Chart—with Two Hundred Parts Numbered and Named.**

A cross-section view, showing clearly and distinctly all the interior of a Submarine of the latest type. You get more information from this chart, about the construction and operation of a Submarine, than in any other way. No details omitted—everything is accurate and to scale. It is absolutely correct in every detail, having been approved by Naval Engineers. All the machinery and devices fitted in a modern Submarine Boat are shown, and to make the engraving more readily understood all the features are shown in operative form, with Officers and Men in the act of performing the duties assigned to them in service conditions. This CHART IS REALLY AN ENCYCLOPEDIA OF A SUBMARINE. It is educational and worth many times its cost. Mailed in a Tube for . . . . . **25 cents**

**Box Car Chart.**

A chart showing the anatomy of a box car, having every part of the car numbered and its proper name given in a reference list. Price . . . . . **25 cents**

**Gondola Car Chart.**

A chart showing the anatomy of a gondola car, having every part of the car numbered and its proper reference name given in a reference list. Price . . . . . **25 cents**

**Passenger-Car Chart.**

A chart showing the anatomy of a passenger-car, having every part of the car numbered and its proper name given in a reference list . . . . . **25 cents**

**Steel Hopper Bottom Coal Car.**

A chart showing the anatomy of a steel Hopper Bottom Coal Car, having every part of the car numbered and its proper name given in a reference list. Price . . . . . **25 cents**

**Traction Power Chart.**

A chart whereby you can find the traction power or drawbar pull of any locomotive without making a figure. Shows what cylinders are equal, how driving wheels and steam pressure affect the power. What sized engine you need to exert a given drawbar pull or anything you desire in this line. Price . . . . . **50 cents**

**Horse-Power Chart.**

Shows the horse-power of any stationary engine without calculation. No matter what the cylinder diameter, of stroke, the steam pressure of cut-off, the revolutions, or whether condensing or non-condensing, it's all there. Easy to use, accurate, and saves time and calculations. Especially useful to engineers and designers. Price . . . . . **50 cents**

**Boiler Room Chart: By GEO. L. FOWLER.**

A chart—size 14x28 inches—showing in isometric perspective the mechanisms belonging in a modern boiler room. The various parts are shown broken or removed, so that the internal construction is fully illustrated. Each part is given a reference number, and these, with the corresponding name, are given in a glossary printed at the sides. This chart is really a dictionary of the boiler room—the names of more than 200 parts being given. Price . . . . . **25 cents**

**COKE**

**Modern Coking Practice, Including Analysis of Materials and Products.**

By J. E. CHRISTOPHER and T. H. BERON.

This, the standard work on the subject, has just been revised. It is a practical work for those engaged in Coke manufacture and the recovery of By-products. Fully illustrated with folding plates. It has been the aim of the authors, in preparing this book, to produce one which shall be of use and benefit to those who are associated with, or interested in, the modern developments of the industry. Among the Chapters contained in Volume I are: Introduction; Classification of Fuels; Impurities of Coals; Coal Washing; Sampling and Valuation of Coals, etc.; Power of Fuels; History of Coke Manufacture; Developments in the Coke Oven Design; Recent Types of Coke Ovens; Mechanical Appliances at Coke Ovens; Chemical and Physical Examination of Coke. Volume II covers fully the subject of By-Products. Price, per volume . . . . . **\$3.00 net**



## COMPRESSED AIR

### **Compressed Air in All Its Applications.** By GARDNER D. HISCOX.

This is the most complete book on the subject of Air that has ever been issued, and its thirty-five chapters include about every phase of the subject one can think of. It may be called an encyclopedia of compressed air. It is written by an expert, who, in its 665 pages, has dealt with the subject in a comprehensive manner, no phase of it being omitted. Includes the physical properties of air from a vacuum to its highest pressure, its thermodynamics, compression, transmission and uses as a motive power, in the Operation of Stationary and Portable Machinery, in Mining, Air Tools, Air Lifts, Pumping of Water, Acids, and Oils; the Air Blast for Cleaning and Painting the Sand Blast and its Work, and the Numerous Appliances in which Compressed Air is a Most Convenient and Economical Transmitter of Power for Mechanical Work, Railway Propulsion, Refrigeration, and the Various Uses to which Compressed Air has been applied. Includes forty-four tables of the physical properties of air, its compression, expansion, and volumes required for various kinds of work, and a list of patents on compressed air from 1875 to date. Over 500 illustrations, 5th Edition, revised and enlarged.

Cloth bound. Price . . . . . **\$5.00**  
 Half Morocco. Price . . . . . **\$6.50**

## CONCRETE

### **Concrete Workers' Reference Books. A Series of Popular Handbooks for Concrete Users.** Prepared by A. A. HOUGHTON. . . . . **50 cents**

*The author, in preparing this Series, has not only treated on the usual types of construction, but explains and illustrates molds and systems that are not patented, but which are equal in value and often superior to those restricted by patents. These molds are very easily and cheaply constructed and embody simplicity, rapidity of operation, and the most successful results in the molded concrete. Each of these books is fully illustrated, and the subjects are exhaustively treated in plain English.*

#### **Concrete Wall Forms.** By A. A. HOUGHTON.

A new automatic wall clamp is illustrated with working drawings. Other types of wall forms, clamps, separators, etc., are also illustrated and explained. (No. 1 of Series) Price **50 cents**

#### **Concrete Floors and Sidewalks.** By A. A. HOUGHTON.

The molds for molding squares, hexagonal and many other styles of mosaic floor and sidewalk blocks are fully illustrated and explained. (No. 2 of Series) Price . . . . . **50 cents**

#### **Practical Concrete Silo Construction.** By A. A. HOUGHTON.

Complete working drawings and specifications are given for several styles of concrete silos, with illustrations of molds for monolithic and block silos. The tables, data, and information presented in this book are of the utmost value in planning and constructing all forms of concrete silos. (No. 3 of Series) Price . . . . . **50 cents**

#### **Molding Concrete Chimneys, Slate and Roof Tiles.** By A. A. HOUGHTON.

The manufacture of all types of concrete slate and roof tile is fully treated. Valuable data on all forms of reinforced concrete roofs are contained within its pages. The construction of concrete chimneys by block and monolithic systems is fully illustrated and described. A number of ornamental designs of chimney construction with molds are shown in this valuable treatise. (No. 4 of Series.) Price . . . . . **50 cents**

#### **Molding and Curing Ornamental Concrete.** By A. A. HOUGHTON.

The proper proportions of cement and aggregates for various finishes, also the method of thoroughly mixing and placing in the molds, are fully treated. An exhaustive treatise on this subject that every concrete worker will find of daily use and value. (No. 5 of Series.) Price . . . . . **50 cents**

#### **Concrete Monuments, Mausoleums and Burial Vaults.** By A. A. HOUGHTON.

The molding of concrete monuments to imitate the most expensive cut stone is explained in this treatise, with working drawings of easily built molds. Cutting inscriptions and designs are also fully treated. (No. 6 of Series.) Price . . . . . **50 cents**

#### **Molding Concrete Bathtubs, Aquariums and Natatoriums.** By A. A. HOUGHTON.

Simple molds and instruction are given for molding many styles of concrete bathtubs, swimming-pools, etc. These molds are easily built and permit rapid and successful work. (No. 7 of Series.) Price . . . . . **50 cents**

**Concrete Bridges, Culverts and Sewers.** By A. A. HOUGHTON.

A number of ornamental concrete bridges with illustrations of molds are given. A collapsible center or core for bridges, culverts and sewers is fully illustrated with detailed instructions for building. (No. 8 of Series.) Price . . . . . **50 cents**

**Constructing Concrete Porches.** By A. A. HOUGHTON.

A number of designs with working drawings of molds are fully explained so any one can easily construct different styles of ornamental concrete porches without the purchase of expensive molds. (No. 9 of Series.) Price . . . . . **50 cents**

**Molding Concrete Flower-Pots, Boxes, Jardinieres, Etc.** By A. A. HOUGHTON.

The molds for producing many original designs of flower-pots, urns, flower-boxes, jardinieres, etc., are fully illustrated and explained, so the worker can easily construct and operate same. (No. 10 of Series.) Price . . . . . **50 cents**

**Molding Concrete Fountains and Lawn Ornaments.** By A. A. HOUGHTON.

The molding of a number of designs of lawn seats, curbing, hitching posts, pergolas, sun dials and other forms of ornamental concrete for the ornamentation of lawns and gardens, is fully illustrated and described. (No. 11 of Series.) Price . . . . . **50 cents**

**Concrete from Sand Molds.** By A. A. HOUGHTON.

A Practical Work treating on a process which has heretofore been held as a trade secret by the few who possessed it, and which will successfully mold every and any class of ornamental concrete work. The process of molding concrete with sand molds is of the utmost practical value, possessing the manifold advantages of a low cost of molds, the ease and rapidity of operation, perfect details to all ornamental designs, density and increased strength of the concrete, perfect curing of the work without attention and the easy removal of the molds regardless of any undercutting the design may have. 192 pages. Fully illustrated Price . . . . . **\$2.00**

**Ornamental Concrete without Molds.** By A. A. HOUGHTON.

The process for making ornamental concrete without molds has long been held as a secret, and now, for the first time, this process is given to the public. The book reveals the secret and is the only book published which explains a simple, practical method whereby the concrete worker is enabled, by employing wood and metal templates of different designs, to mold or model in concrete any Cornice, Archivol, Column, Pedestal, Base Cap, Urn or Pier in a monolithic form—right upon the job. These may be molded in units or blocks and then built up to suit the specifications demanded. This work is fully illustrated, with detailed engravings. Price . . . . . **\$2.00**

**Concrete for the Farm and in the Shop.** By H. COLIN CAMPBELL, C.E., E.M.

"Concrete for the Farm and in the Shop" is a new book from cover to cover, illustrating and describing in plain, simple language many of the numerous applications of concrete within the range of the home worker. Among the subjects treated are: Principles of Reinforcing; Methods of Protecting Concrete so as to Insure Proper Hardening; Home-made Mixers; Mixing by Hand and Machine; Form Construction, Described and Illustrated by Drawings and Photographs; Construction of Concrete Walls and Fences; Concrete Fence Posts; Concrete Gate Posts; Corner Posts; Clothes Line Posts; Grape Arbor Posts; Tanks; Troughs; Cisterns; Hog Wallows; Feeding Floors and Barnyard Pavements; Foundations; Well Curbs and Platforms; Indoor Floors; Sidewalks; Steps; Concrete Hotbeds and Cold Frames; Concrete Slab Roofs; Walls for Buildings; Repairing Leaks in Tanks and Cisterns; and all topics associated with these subjects as bearing upon securing the best results from concrete are dwelt upon at sufficient length in plain every-day English so that the inexperienced person desiring to undertake a piece of concrete construction can, by following the directions set forth in this book, secure 100 per cent. success every time. A number of convenient and practical tables for estimating quantities, and some practical examples, are also given. (5x7.) 149 pages. 51 illustrations. Price . . . . . **.75 cents**

**Popular Handbook for Cement and Concrete Users.** By MYRON H. LEWIS.

This is a concise treatise of the principles and methods employed in the manufacture and use of cement in all classes of modern works. The author has brought together in this work all the salient matter of interest to the user of concrete and its many diversified products. The matter is presented in logical and systematic order, clearly written, fully illustrated and free from involved mathematics. Everything of value to the concrete user is given, including kinds of cement employed in construction, concrete architecture, inspection and testing, waterproofing, coloring and painting, rules, tables, working and cost data. The book comprises thirty-three chapters, as follow: Introductory. Kinds of Cement and How They are Made. Properties. Testing and Requirements of Hydraulic Cement. Concrete and Its Properties. Sand, Broken Stone and Gravel for Concrete. How to Proportion the Materials. How to Mix and Place Concrete. Forms of Concrete Construction. The Architectural and Artistic Possibilities of Concrete. Concrete Residences. Mortars, Plasters and Stucco, and How to Use Them. The Artistic Treatment of Concrete Surfaces. Concrete Building

Blocks. The Making of Ornamental Concrete. Concrete Pipes, Sences, Posts, etc. Essential Features and Advantages of Reinforced Concrete. How to Design Reinforced Concrete Beams, Slabs and Columns. Explanations of the Methods and Principles in Designing Reinforced Concrete Beams and Slabs. Systems of Reinforcement Employed. Reinforced Concrete in Factory and General Building Construction. Concrete in Foundation Work. Concrete Retaining Walls, Abutments and Bulkheads. Concrete Arches and Arch Bridges. Concrete Beam and Girder Bridges. Concrete in Sewerage and Draining Works. Concrete Tanks, Dams and Reservoirs. Concrete Sidewalks, Curbs and Pavements. Concrete and Railroad Construction. The Utility of Concrete on the Farm. The Waterproofing of Concrete Structures. Grout of Liquid Concrete and Its Use. Inspection of Concrete Work. Cost of Concrete Work. Some of the special features of the book are: 1.—The Attention Paid to the Artistic and Architectural Side of Concrete Work. 2.—The Authoritative Treatment of the Problem of Waterproofing Concrete. 3.—An Excellent Summary of the Rules to be Followed in Concrete Construction. 4.—The Valuable Cost Data and Useful Tables given. A valuable addition to the library of every cement and concrete user. Price \$2.00

**WHAT IS SAID OF THIS BOOK:**

"The field of Concrete Construction is well covered and the matter contained is well within the understanding of any person."—*Engineering Contracting*.  
 "Should be on the bookshelves of every contractor, engineer and architect in this field."—*National Builder*.

**Waterproofing Concrete.** By **MIRON H. LEWIS.**

Modern Methods of Waterproofing Concrete and Other Structures. A condensed statement of the Principles, Rules, and Precautions to be Observed in Waterproofing and Waterproofing Structures and Structural Materials. Paper binding. Illustrated. Price 50 cents

**DICTIONARIES**

**Aviation Terms. Termes D'Aviation. English-French. French-English.**  
 Compiled by Lieuts. VICTOR W. PAGE, A.S., S.C.U.S.R., and PAUL MONTARIOL, of the French Flying Corps, on duty, on Signal Corps Aviation School, Mineola, L. I.

The lists contained are confined to essentials, and special folding plates are included to show all important airplane parts. The lists are divided in four sections as follows: 1.—Flying Field Terms. 2.—The Airplane. 3.—The Engine. 4.—Tools and Shop Terms. A complete, well illustrated volume intended to facilitate conversation between English-speaking and French aviators. A very valuable book for all who are about to leave for duty overseas.

Approved for publication by Major W. G. Kilmer, S.C., U.S.C.O. Signal Corps Aviation School, Hazelhurst Field, Mineola, L. I. This book should be in every Aviator's and Mechanic's Kit for ready reference. 128 pages, fully illustrated, with detailed engravings. Price \$1.00

**Standard Electrical Dictionary.** By T. O'CONNOR SLOANE.

An indispensable work to all interested in electrical science. Suitable alike for the student and professional. A practical handbook of reference containing definitions of about 5,000 distinct words, terms and phrases. The definitions are terse and concise and include every term used in electrical science. Recently issued. An entirely new edition. Should be in the possession of all who desire to keep abreast with the progress of this branch of science. Complete, concise and convenient. 682 pages, 393 illustrations. Price \$3.00

**DIES—METAL WORK**

**Dies: Their Construction and Use for the Modern Working of Sheet Metals.**  
 By J. V. WOODWORTH.

A most useful book, and one which should be in the hands of all engaged in the press working of metals; treating on the Designing, Constructing, and Use of Tools, Fixtures and Devices, together with the manner in which they should be used in the Power Press; for the cheap and rapid production of the great variety of sheet-metal articles now in use. It is designed as a guide to the production of sheet-metal parts at the minimum of cost with the maximum of output. The hardening and tempering of Press tools and the classes of work which may be produced to the best advantage by the use of dies in the power press are fully treated. Its 515 illustrations show dies, press fixtures and sheet-metal working devices, the descriptions of which are so clear and practical that all metal-working mechanics will be able to understand how to design, construct and use them. Many of the dies and press fixtures treated were either constructed by the author or under his supervision. Others were built by skillful mechanics and are in use in large sheet-metal establishments and machine shops. 4th Revised and Enlarged Edition. Price \$3.00

**Punches, Dies and Tools for Manufacturing in Presses.** By J. V. WOODWORTH.

This work is a companion volume to the author's elementary work entitled "Dies: Their Construction and Use." It does not go into the details of die-making to the extent of the author's previous book, but gives a comprehensive review of the field of operations carried on by presses. A large part of the information given has been drawn from the author's personal experience. It might well be termed an Encyclopedia of Die-Making, Punch-Making, Die-Sinking, Sheet-Metal Working, and Making of Special Tools, Sub-presses, Devices and Mechanical Combinations for Punching, Cutting, Bending, Forming, Piercing, Drawing, Compressing and Assembling Sheet-Metal Parts, and also Articles of other Materials in Machine Tools. 2d Edition. Price . . . . . \$4.00

**Drop Forging, Die-Sinking and Machine-Forming of Steel.** By J. V. WOODWORTH.

This is a practical treatise on Modern Shop Practice, Processes, Methods, Machine Tools, and Details treating on the Hot and Cold Machine-Forming of Steel and Iron into Duplicate Shapes; together with Tools, Dies, and Machinery involved in the manufacture of Duplicate Forgings and Interchangeable Hot and Cold Pressed Parts from Bar and Sheet Metal. This book fills a demand of long standing for information regarding drop-forgings, die-sinking and machine-forming of steel and the shop practice involved, as it actually exists in the modern drop-forging shop. The processes of die-sinking and force-making, which are thoroughly described and illustrated in this admirable work, are rarely to be found explained in such a clear and concise manner as is here set forth. The process of die-sinking relates to the engraving or sinking of the female or lower dies, such as are used for drop-forgings, hot and cold machine-forging, swedging, and the press working of metals. The process of force-making relates to the engraving or raising of the male or upper dies used in producing the lower dies for the press-forming and machine-forging of duplicate parts of metal. In addition to the arts above mentioned the book contains explicit information regarding the drop-forging and hardening plants, designs, conditions, equipment, drop hammers, forging machines, etc., machine forging, hydraulic forging, autogenous welding and shop practice. The book contains eleven chapters, and the information contained in these chapters is just what will prove most valuable to the forged-metal worker. All operations described in the work are thoroughly illustrated by means of perspective half-tones and outline sketches of the machinery employed. 800 detailed illustrations. Price . . . . . \$2.50

**DRAWING—SKETCHING PAPER**

**Practical Perspective.** By RICHARDS and COLVIN.

Shows just how to make all kinds of mechanical drawings in the only practical perspective isometric. Makes everything plain, so that any mechanic can understand a sketch or drawing in this way. Saves time in the drawing room, and mistakes in the shops. Contains practical examples of various classes of work. 4th Edition. Price . . . . . 50 cents

**Linear Perspective Self-Taught.** By HERMAN T. C. KRAUS.

This work gives the theory and practice of linear perspective, as used in architectural, engineering and mechanical drawings. Persons taking up the study of the subject by themselves will be able, by the use of the instruction given, to readily grasp the subject, and by reasonable practice become good perspective draftsmen. The arrangement of the book is good; the plate is on the left-hand, while the descriptive text follows on the opposite page, so as to be readily referred to. The drawings are on sufficiently large scale to show the work clearly and are plainly figured. There is included a self-explanatory chart which gives all information necessary for the thorough understanding of perspective. This chart alone is worth many times over the price of the book. 2d Revised and Enlarged Edition. Price . . . . . \$2.50

**Self-Taught Mechanical Drawing and Elementary Machine Design.** By F. L. SYLVESTER, M.E., Draftsman, with additions by ERIC OBERG, associate editor of "Machinery."

This is a practical treatise on Mechanical Drawing and Machine Design, comprising the first principles of geometric and mechanical drawing, workshop mathematics, mechanics, strength of materials and the calculations and design of machine details. The author's aim has been to adapt this treatise to the requirements of the practical mechanic and young draftsman and to present the matter in as clear and concise a manner as possible. To meet the demands of this class of students, practically all the important elements of machine design have been dealt with, and in addition algebraic formulas have been explained, and the elements of trigonometry treated in the manner best suited to the needs of the practical man. The book is divided into 20 chapters, and in arranging the material, mechanical drawing, pure and simple, has been taken up first, as a thorough understanding of the principles of representing objects facilitates the further study of mechanical subjects. This is followed by the mathematics necessary for the solution of the problems in machine design which are presented later, and a practical introduction to theoretical mechanics and the strength of materials. The various elements entering into machine design, such as cams, gears, sprocket-wheels, cone pulleys, bolts, screws, couplings, clutches, shafting and fly-wheels, have been treated in such a way as to make possible the use of the work as a text-book for a continuous course of study. It is easily comprehended and assimilated even by students of limited previous training. 330 pages, 215 engravings. Price . . . . . \$2.00

**A New Sketching Paper.**

A new specially ruled paper to enable you to make sketches or drawings in isometric perspective without any figuring or fussing. It is being used for shop details as well as for assembly drawings, as it makes one sketch do the work of three, and no workman can help seeing just what is wanted.

Pads of 40 sheets, 6x9 inches.	Price . . . . .	25 cents
Pads of 40 sheets, 9x12 inches.	Price . . . . .	50 cents
40 sheets, 12x18 inches.	Price . . . . .	\$1.00

**ELECTRICITY**

**Arithmetic of Electricity.** By Prof. T. O'CONNOR SLOANE.

A practical treatise on electrical calculations of all kinds reduced to a series of rules, all of the simplest forms, and involving only ordinary arithmetic; each rule illustrated by one or more practical problems, with detailed solution of each one. This book is classed among the most useful works published on the science of electricity, covering as it does the mathematics of electricity in a manner that will attract the attention of those who are not familiar with algebraical formulas. 20th Edition. 160 pages. Price . . . . . **\$1.00**

**Commutator Construction.** By WM. BAXTER, JR.

The business end of any dynamo or motor of the direct current type is the commutator. This book goes into the designing, building, and maintenance of commutators, shows how to locate troubles and how to remedy them; everyone who fusses with dynamos needs this. 4th Edition. Price . . . . . **25 cents**

**Dynamo Building for Amateurs, or How to Construct a Fifty-Watt Dynamo.**

By ARTHUR J. WEED, Member of N. Y. Electrical Society.

A practical treatise showing in detail the construction of a small dynamo or motor, the entire machine work of which can be done on a small foot lathe. Dimensioned working drawings are given for each piece of machine work, and each operation is clearly described. This machine, when used as a dynamo, has an output of fifty watts; when used as a motor it will drive a small drill press or lathe. It can be used to drive a sewing machine on any and all ordinary work. The book is illustrated with more than sixty original engravings, showing the actual construction of the different parts. Among the contents are chapters on: 1. Fifty-Watt Dynamo. 2. Side Bearing Rods. 3. Field Punching. 4. Bearings. 5. Commutator. 6. Pulley. 7. Brush Holders. 8. Connection Board. 9. Armature Shaft. 10. Armature. 11. Armature Winding. 12. Field Winding. 13. Connecting and starting.

Paper. Price . . . . .	50 cents
Cloth. Price . . . . .	\$1.00

**Electric Bells.** By M. B. SLEEPER.

A complete treatise for the practical worker in Installing, Operating and Testing Bell Circuits, Burglar Alarms, Thermostats, and other apparatus used with Electric Bells.

Both the electrician and the experimenter will find in this book new material which is essential in their work. Tools, bells, batteries, unusual circuits, burglar alarms, annunciator systems, thermostats, circuit breakers, time alarms, and other apparatus used in bell circuits are described from the standpoints of their application, construction and repair. The detailed instruction for building the apparatus will appeal to the experimenter particularly.

The practical worker will find the chapter on Wiring, Calculation of Wire Sizes and Magnet Winding, Upkeep of Systems, and the Location of Faults, of the greatest value in their work. Among the chapters are: Tools and Materials for Bell Work; How and Why Bell Work; Batteries for Small Installations; Making Bells and Push Buttons; Wiring Bell Systems; Construction of Annunciators and Signals; Burglary Alarms and Auxiliary Apparatus; More Elaborate Bell Systems; Finding Faults and Remedying Them. 124 pages, fully illustrated. Price . . . . . **50 cents**

**Electric Lighting and Heating Pocket Book.** By SYDNEY F. WALKER.

This book puts in convenient form useful information regarding the apparatus which is likely to be attached to the mains of an electrical company. Tables of units and equivalents are included and useful electrical laws and formulas are stated. 438 pages, 300 engravings. Bound in leather. Pocket book form. Price . . . . . **\$3.00**

**Electric Wiring, Diagrams and Switchboards.** By NEWTON HARRISON, with additions by THOMAS POPPE.

A thoroughly practical treatise covering the subject of Electric Wiring in all its branches, including explanations and diagrams which are thoroughly explicit and greatly simplify the subject. Practical, every-day problems in wiring are presented and the method of obtaining intelligent results clearly shown. Only arithmetic is used. Ohm's law is given a simple explanation with reference to wiring for direct and alternating currents. The fundamental principle of drop of potential in circuits is shown with its various applications. The simple circuit is developed with the position of mains, feeders and branches; their treatment

as a part of a wiring plan and their employment in house wiring clearly illustrated. Some simple facts about testing are included in connection with the wiring. Molding and conduit work are given careful consideration; and switchboards are systematically treated, built up and illustrated, showing the purpose they serve, for connection with the circuits, and to shunt and compound wound machines. The simple principles of switchboard construction, the development of the switchboard, the connections of the various instruments, including the lightning arrester, are also plainly set forth.

Alternating current wiring is treated, with explanations of the power factor, conditions calling for various sizes of wire, and a simple way of obtaining the sizes for single-phase, two-phase and three-phase circuits. This is the only complete work issued showing and telling you what you should know about direct and alternating current wiring. It is a ready reference. The work is free from advanced technicalities and mathematics, arithmetic being used throughout. It is in every respect a handy, well-written, instructive, comprehensive volume on wiring for the wireman, foreman, contractor, or electrician. 2nd Revised Edition. 303 pages, 130 illustrations. Price . . . . .**\$1.50**

**Electric Furnaces and their Industrial Applications.** By J. WRIGHT.

This is a book which will prove of interest to many classes of people; the manufacturer who desires to know what product can be manufactured successfully in the electric furnace, the chemist who wishes to post himself on the electro-chemistry, and the student of science who merely looks into the subject from curiosity. New, Revised and Enlarged Edition. 320 pages. Fully illustrated, cloth. Price . . . . .**\$3.00**

**Electric Toy Making, Dynamo Building, and Electric Motor Construction.**  
By Prof. T. O'CONNOR SLOANE.

This work treats of the making at home of electrical toys, electrical apparatus, motors, dynamos, and instruments in general, and is designed to bring within the reach of young and old the manufacture of genuine and useful electrical appliances. The work is especially designed for amateurs and young folks.

Thousands of our young people are daily experimenting, and busily engaged in making electrical toys and apparatus of various kinds. The present work is just what is wanted to give the much needed information in a plain, practical manner, with illustrations to make easy the carrying out of the work. 20th Edition. Price . . . . .**\$1.00**

**Practical Electricity.** By Prof. T. O'CONNOR SLOANE.

This work of 768 pages was previously known as Sloane's Electricians' Hand Book, and is intended for the practical electrician who has to make things go. The entire field of electricity is covered within its pages. Among some of the subjects treated are: The Theory of the Electric Current and Circuit, Electro-Chemistry, Primary Batteries, Storage Batteries, Generation and Utilisation of Electric Powers, Alternating Current, Armature Winding, Dynamos and Motors, Motor Generators, Operation of the Central Station Switchboards, Safety Appliances, Distribution of Electric Light and Power, Street Mains, Transformers, Arc and Incandescent Lighting, Electric Measurements, Photometry, Electric Railways, Telephony, Bell-Wiring, Electric-Plating, Electric Heating, Wireless Telegraphy, etc. It contains no useless theory; everything is to the point. It teaches you just what you want to know about electricity. It is the standard work published on the subject. Forty-one chapters, 556 engravings. Price . . . . .**\$2.50**

**Electricity Simplified.** By Prof. T. O'CONNOR SLOANE.

The object of "Electricity Simplified" is to make the subject as plain as possible and to show what the modern conception of electricity is; to show how two plates of different metal, immersed in acid, can send a message around the globe; to explain how a bundle of copper wire rotated by a steam engine can be the agent in lighting our streets, to tell what the volt, ohm and ampere are, and what high and low tension mean; and to answer the questions that perpetually arise in the mind in this age of electricity. 13th Edition. 172 pages. Illustrated. Price . . . . .**\$1.00**

**House Wiring.** By THOMAS W. POPPE.

This work describes and illustrates the actual installation of Electric Light Wiring, the manner in which the work should be done, and the method of doing it. The book can be conveniently carried in the pocket. It is intended for the Electrician, Helper and Apprentice. It solves all Wiring Problems and contains nothing that conflicts with the rulings of the National Board of Fire Underwriters. It gives just the information essential to the Successful Wiring of a Building. Among the subjects treated are: Locating the Meter. Panel-Boards. Switches. Plug Receptacles. Brackets. Ceiling Fixtures. The Meter Connections. The Feed Wires. The Steel Armored Cable System. The Flexible Steel Conduit System. The Ridg Conduit System. A digest of the National Board of Fire Underwriters' rules relating to metallic wiring systems. Various switching arrangements explained and diagrammed. The easiest method of testing the Three- and Four-way circuits explained. The grounding of all metallic wiring systems and the reason for doing so shown and explained. The insulation of the metal parts of lamp fixtures and the reason for the same described and illustrated. 125 pages. 2nd Edition, revised and enlarged. Fully illustrated. Flexible cloth. Price . . . . .**50 cents**

**How to Become a Successful Electrician.** By Prof. T. O'CONNOR SLOANE.

Every young man who wishes to become a successful electrician should read this book. It tells in simple language the surest and easiest way to become a successful electrician. The studies to be followed, methods of work, field of operation and the requirements of the successful electrician are pointed out and fully explained. Every young engineer will find this an excellent stepping stone to more advanced works on electricity which he must master before success can be attained. Many young men become discouraged at the very outset by attempting to read and study books that are far beyond their comprehension. This book serves as the connecting link between the rudiments taught in the public schools and the real study of electricity. It is interesting from cover to cover. 18th Revised Edition, just issued. 205 pages. Illustrated. Price **\$1.00**

**Management of Dynamos.** By LUMMIS-PATERSON.

A handbook of theory and practice. This work is arranged in three parts. The first part covers the elementary theory of the dynamo. The second part, the construction and action of the different classes of dynamo in common use are described, while the third part relates to such matters as affect the practical management and working of dynamos and motors. 4th Edition. 292 pages, 117 illustrations. Price **\$1.50**

**Standard Electrical Dictionary.** By T. O'CONNOR SLOANE.

An indispensable work to all interested in electrical science. Suitable alike for the student and professional. A practical handbook of reference containing definitions of about 5,000 distinct words, terms and phrases. The definitions are terse and concise and include every term used in electrical science. Recently issued. An entirely new edition. Should be in the possession of all who desire to keep abreast with the progress of this branch of science. In its arrangement and typography the book is very convenient. The word or term defined is printed in black-faced type, which readily catches the eye, while the body of the page is in smaller but distinct type. The definitions are well worded, and so as to be understood by the non-technical reader. The general plan seems to be to give an exact, concise definition, and then amplify and explain in a more popular way. Synonyms are also given, and references to other words and phrases are made. A very complete and accurate index of fifty pages is at the end of the volume, and as this index contains all synonyms, and as all phrases are indexed in every reasonable combination of words, reference to the proper place in the body of the book is readily made. It is difficult to decide how far a book of this character is to keep the dictionary form, and to what extent it may assume the encyclopedia form. For some purposes, concise, exactly worded definitions are needed; for other purposes, more extended descriptions are required. This book seeks to satisfy both conditions and has succeeded with considerable success. 652 pages, 393 illustrations. 12th Edition. Price **\$3.00**

**Storage Batteries Simplified.** By VICTOR W. PAGE, M.E.

A complete treatise on storage battery operating principles, repairs and applications. The greatly increasing application of storage batteries in modern engineering and mechanical work has created a demand for a book that will consider this subject completely and exclusively. This is the most thorough and authoritative treatise ever published on this subject. It is written in easily understandable, non-technical language so that any one may grasp the basic principles of storage battery action as well as their practical industrial applications. All electric and gasoline automobiles use storage batteries. Every automobile repairman, dealer or salesman should have a good knowledge of maintenance and repair of these important elements of the motor car mechanism. This book not only tells how to charge, care for and rebuild storage batteries but, also outlines all the industrial uses. Learn how they run street cars, locomotives and factory trucks. Get an understanding of the important functions they perform in submarine boats, isolated lighting plants, railway switch and signal systems, marine applications, etc. This book tells how they are used in central station standby service, for starting automobile motors and in ignition systems. Every practical use of the modern storage battery is outlined in this treatise. 320 pages, fully illustrated. Price **\$1.50**

**Switchboards.** By WILLIAM BAXTER, JR.

This book appeals to every engineer and electrician who wants to know the practical side of things. It takes up all sorts and conditions of dynamos, connections and circuits, and shows by diagram and illustration just how the switchboard should be connected. Includes direct and alternating current boards, also those for arc-lighting, incandescent and power circuits. Special treatment on high voltage boards for power transmission. 2nd Edition. 190 pages, Illustrated. Price **\$1.50**

**Telephone Construction, Installation, Wiring, Operation and Maintenance.**

By W. H. RADCLIFFE and H. C. CUSHING.

This book is intended for the amateur, the wireman, or the engineer who desires to establish a means of telephonic communication between the rooms of his home, office, or shop. It deals only with such things as may be of use to him rather than with theories. Gives the principles of construction and operation of both the Bell and Independent instruments; approved methods of installing and wiring them; the means of protecting them from lightning and abnormal currents; their connection together for operation as series or bridging stations; and rules for their inspection and maintenance. Line wiring and the wiring and operation of special telephone systems are also treated. Intricate mathematics are avoided, and all apparatus, circuits and systems are thoroughly described. The appendix

contains definitions of units and terms used in the text. Selected wiring tables, which are very helpful, are also included. Among the subjects treated are Construction, Operation, and Installation of Telephone Instruments; Inspection and Maintenance of Telephone Instruments; Telephone Line Wiring; Testing Telephone Line Wires and Cables; Wiring and Operation of Special Telephone Systems, etc. 2nd Edition, Revised and Enlarged. 223 pages, 154 illustrations \$1.00

**Wireless Telegraphy and Telephony Simply Explained.** By ALFRED P. MORGAN.

This is undoubtedly one of the most complete and comprehensible treatises on the subject ever published, and a close study of its pages will enable one to master all the details of the wireless transmission of messages. The author has filled a long-felt want and has succeeded in furnishing a lucid, comprehensible explanation in simple language of the theory and practice of wireless telegraphy and telephony.

Among the contents are: Introductory; Wireless Transmission and Reception—The Aerial System, Earth Connections—The Transmitting Apparatus, Spark Coils and Transformers, Condensers, Helices, Spark Gaps, Anchor Gaps, Aerial Switches—The Receiving Apparatus, Detectors, etc.—Tuning and Coupling, Tuning Coils, Lodge Couplers, Variable Condensers, Directive Wave Systems—Miscellaneous Apparatus, Telephone Receivers, Range of Stations, Static Interference—Wireless Telephones, Sound and Sound Waves, The Vocal Cords and Ear—Wireless Telephone, How Sounds Are Changed into Electric Waves—Wireless Telephones; The Apparatus—Summary. 154 pages, 156 engravings. Price \$1.00

**Wiring a House.** By HERBERT PRATT.

Shows a house already built; tells just how to start about wiring it; where to begin; what wire to use; how to run it according to Insurance Rules; in fact, just the information you need. Directions apply equally to a shop. 4th Edition. Price 25 cents

**FACTORY MANAGEMENT, ETC.**

**Modern Machine Shop Construction, Equipment and Management.** By

O. E. PRANGE, M.E.

The only work published that describes the modern machine shop or manufacturing plant from the time the grass is growing on the site intended for it until the finished product is shipped. By a careful study of its thirty-two chapters the practical man may economically build, efficiently equip, and successfully manage the modern machine shop or manufacturing establishment. Just the book needed by those contemplating the erection of modern shop buildings, the rebuilding and reorganization of old ones, or the introduction of modern shop methods, time and cost systems. It is a book written and illustrated by a practical shop man for practical shop men who are too busy to read theories and want facts. It is the most complete all-around book of its kind ever published. It is a practical book for practical men, from the apprentice in the shop to the president in the office. It minutely describes and illustrates the most simple and yet the most efficient time and cost system yet devised. 2nd Revised and Enlarged Edition, just issued. 384 pages, 219 illustrations. Price \$5.00

**FUEL**

**Combustion of Coal and the Prevention of Smoke.** By WM. M. BARR.

This book has been prepared with special reference to the generation of heat by the combustion of the common fuels found in the United States, and deals particularly with the conditions necessary to the economic and smokeless combustion of bituminous coals in Stationary and Locomotive Steam Boilers.

The presentation of this important subject is systematic and progressive. The arrangement of the book is in a series of practical questions to which are appended accurate answers, which describe in language, free from technicalities, the several processes involved in the furnace combustion of American fuels; it clearly states the essential requisites for perfect combustion, and points out the best methods for furnace construction for obtaining the greatest quantity of heat from any given quality of coal. Nearly 350 pages, fully illustrated. Price \$1.00

**Smoke Prevention and Fuel Economy.** By BOOTH and KERSHAW.

A complete treatise for all interested in smoke prevention and combustion, being based on the German work of Ernst Schmatolla, but it is more than a mere translation of the German treatise, much being added. The authors show as briefly as possible the principles of fuel combustion, the methods which have been and are at present in use, as well as the proper scientific methods for obtaining all the energy in the coal and burning it without smoke. Considerable space is also given to the examination of the waste gases, and several of the representative English and American mechanical stoker and similar appliances are described. The losses carried away in the waste gases are thoroughly analyzed and discussed in the Appendix, and abstracts are also here given of various patents on combustion apparatus. The book is complete and contains much of value to all who have charge of large plants. 194 pages illustrated. Price \$2.50



## GAS ENGINES AND GAS

**Gas, Gasoline and Oil Engines.** By GARDNER D. HISCOX. Revised by VICTOR W. PAGÉ, M.E.

Just issued New 1918 Edition, Revised and Enlarged. Every user of a gas engine needs this book. Simple, instructive and right up-to-date. The only complete work on the subject. Tells all about internal combustion engineering, treating exhaustively on the design, construction and practical application of all forms of gas, gasoline, kerosene and crude petroleum-oil engines. Describes minutely all auxiliary systems, such as lubrication, carburetion and ignition. Considers the theory and management of all forms of explosive motors for stationary and marine work, automobiles, aeroplanes and motor-cycles. Includes also Producer Gas and Its Production. Invaluable instructions for all students, gas-engine owners, gas-engineers, patent experts, designers, mechanics, draftsmen and all having to do with the modern power. Illustrated by over 400 engravings, many specially made from engineering drawings, all in correct proportion. 650 pages, 435 engravings. Price . . . . . **\$2.50 net**

**The Gasoline Engine on the Farm: Its Operation, Repair and Uses.** By XENO W. PUTNAM.

This is a practical treatise on the Gasoline and Kerosene Engine intended for the man who wants to know just how to manage his engine and how to apply it to all kinds of farm work to the best advantage.

This book abounds with hints and helps for the farm and suggestions for the home and household. There is so much of value in this book that it is impossible to adequately describe it in such small space. Suffice to say that it is the kind of a book every farmer will appreciate and every farm home ought to have. Includes selecting the most suitable engine for farm work, its most convenient and efficient installation, with chapters on troubles, their remedies, and how to avoid them. The care and management of the farm tractor in plowing, harrowing, harvesting and road grading are fully covered; also plain directions are given for handling the tractor on the road. Special attention is given to relieving farm life of its drudgery by applying power to the disagreeable small tasks which must otherwise be done by hand. Many home-made contrivances for cutting wood, supplying kitchen, garden, and barn with water, loading, hauling and unloading hay, delivering grain to the bins or the feed trough are included; also full directions for making the engine milk the cows, churn, wash, sweep the house and clean the windows, etc. Very fully illustrated with drawings of working parts and cuts showing Stationary, Portable and Tractor Engines doing all kinds of farm work. All money-making farms utilize power. Learn how to utilize power by reading the pages of this book. It is an aid to the result getter, invaluable to the up-to-date farmer, student, blacksmith, implement dealer and, in fact, all who can apply practical knowledge of stationary gasoline engines or gas tractors to advantage. 530 pages. Nearly 180 engravings. Price **\$2.00**

### WHAT IS SAID OF THIS BOOK:

"Am much pleased with the book and find it to be very complete and up-to-date. I will heartily recommend it to students and farmers whom I think would stand in need of such a work, as I think it is an exceptionally good one."—*N. S. Gardner*, Prof. in Charge, Clemson Agr. College of S. C.; Dept. of Agri. and Agri. Exp. Station, Clemson College, S. C.

"I feel that Mr. Putnam's book covers the main points which a farmer should know."—*R. T. Burdick*, Instructor in Agronomy, University of Vermont, Burlington, Vt.

**Gasoline Engines: Their Operation, Use and Care.** By A. HYATT VERRILL.

The simplest, latest and most comprehensive popular work published on Gasoline Engines, describing what the Gasoline Engine is; its construction and operation; how to install it; how to select it; how to use it and how to remedy troubles encountered. Intended for Owners, Operators and Users of Gasoline Motors of all kinds. This work fully describes and illustrates the various types of Gasoline Engines used in Motor Boats, Motor Vehicles and Stationary Work. The parts, accessories and appliances are described with chapters on ignition, fuel, lubrication, operation and engine troubles. Special attention is given to the care, operation and repair of motors, with useful hints and suggestions on emergency repairs and makeshifts. A complete glossary of technical terms and an alphabetically arranged table of troubles and their symptoms form most valuable and unique features of this manual. Nearly every illustration in the book is original, having been made by the author. Every page is full of interest and value. A book which you cannot afford to be without. 275 pages, 162 specially made engravings. Price . . . . . **\$1.50**

**Gas Engine Construction, or How to Build a Half-horsepower Gas Engine.**

By PARSELL and WEED.

A practical treatise of 300 pages describing the theory and principles of the action of Gas Engines of various types and the design and construction of a half-horsepower Gas Engine, with illustrations of the work in actual progress, together with the dimensioned working drawings, giving clearly the sizes of the various details; for the student, the scientific investigator and the amateur mechanic. This book treats of the subject more from the standpoint of practice than that of theory. The principles of operation of Gas Engines are clearly and simply described, and then the actual construction of a half-horsepower engine is taken up, step by step, showing in detail the making of the Gas Engine. 3rd Edition. 300 pages. Price . . . . . **\$2.50**

**How to Run and Install Two- and Four-Cycle Marine Gasoline Engines.**  
By C. VON CULIN.

Revised and enlarged edition just issued. The object of this little book is to furnish a pocket instructor for the beginner, the busy man who uses an engine for pleasure or profit, but who does not have the time or inclination for a technical book, but simply to thoroughly understand how to properly operate, install and care for his own engine. The index refers to each trouble, remedy, and subject alphabetically. Being a quick reference to find the cause, remedy and prevention for troubles, and to become an expert with his own engine. Pocket size. Paper binding. Price . . . . . **25 cents**

**Modern Gas Engines and Producer Gas Plants.** By R. E. MATHOT.

A guide for the gas engine designer, user, and engineer in the construction, selection, purchase, installation, operation, and maintenance of gas engines. More than one book on gas engines has been written, but not one has thus far even encroached on the field covered by this book. Above all, Mr. Mathot's work is a practical guide. Recognizing the need of a volume that would assist the gas engine user in understanding thoroughly the motor upon which he depends for power, the author has discussed his subject without the help of any mathematics and without elaborate theoretical explanations. Every part of the gas engine is described in detail, tersely, clearly, with a thorough understanding of the requirements of the mechanic. Helpful suggestions as to the purchase of an engine, its installation, care, and operation, form a most valuable feature of the work. 320 pages, 175 detailed illustrations. Price . . . **\$2.50**

**The Modern Gas Tractor.** By VICTOR W. PAGÉ, M.E.

A complete treatise describing all types and sizes of gasoline, kerosene and oil tractors. Considers design and construction exhaustively, gives complete instructions for care, operation and repair, outlines all practical applications on the road and in the field. The best and latest work on farm tractors and tractor power plants. A work needed by farmers, students, blacksmiths, mechanics, salesmen, implement dealers, designers and engineers. 2nd Edition, Revised. 504 pages, 228 illustrations, 3 folding plates. Price . . . . . **\$2.00**

**GEARING AND CAMS**

**Bevel Gear Tables.** By D. AG. ENGSTROM.

A book that will at once commend itself to mechanics and draftsmen. Does away with all the trigonometry and fancy figuring on bevel gears, and makes it easy for anyone to lay them out or make them just right. There are 36 full-page tables that show every necessary dimension for all sizes or combinations you're apt to need. No puzzling, figuring or guessing. Gives placing distance, all the angles (including cutting angles), and the correct cutter to use. A copy of this prepares you for anything in the bevel-gear line. 3rd Edition. 66 pages. Price . . . . . **\$1.00**

**Change Gear Devices.** By OSCAR E. PERRIGO.

A practical book for every designer, draftsman, and mechanic interested in the invention and development of the devices for feed changes on the different machines requiring such mechanism. All the necessary information on this subject is taken up, analyzed, classified, sifted, and concentrated for the use of busy men who have not the time to go through the masses of irrelevant matter with which such a subject is usually encumbered and select such information as will be useful to them. It shows just what has been done, how it has been done, when it was done, and who did it. It saves time in hunting up patent records and re-inventing old ideas. 88 pages. 3rd Edition. Price . . . . . **\$1.00**

**Drafting of Cams.** By LOUIS ROUILLION.

The laying out of cams is a serious problem unless you know how to go at it right. This puts you on the right road for practically any kind of cam you are likely to run up against. 3rd Edition. Price . . . . . **25 cents**

**HYDRAULICS**

**Hydraulic Engineering.** By GARDNER D. HISCOX.

A treatise on the properties, power, and resources of water for all purposes. Including the measurement of streams, the flow of water in pipes or conduits; the horsepower of falling water, turbine and impact water-wheels, wave motors, centrifugal, reciprocating and air-lift pumps. With 300 figures and diagrams and 36 practical tables. All who are interested in water-works development will find this book a useful one, because it is an entirely practical treatise upon a subject of present importance and cannot fail in having a far-reaching influence, and for this reason should have a place in the working library of every engineer. Among the subjects treated are: Historical Hydraulics; Properties of Water; Measurement of the Flow of Streams:

Flow from Sub-surface Orifices and Nozzles; Flow of Water in Pipes; Siphons of Various Kinds; Dams and Great Storage Reservoirs; City and Town Water Supply; Wells and Their Reinforcement; Air-lift Methods of Raising Water; Artesian Wells; Irrigation of Arid Districts; Water Power; Water Wheels; Pumps and Pumping Machinery; Reciprocating Pumps; Hydraulic Power Transmission; Hydraulic Mining; Canals; Ditches; Conduits and Pipe Lines; Marine Hydraulics; Tidal and Sea Wave Power, etc. 320 pages. Price . . . \$4.00

**ICE AND REFRIGERATION**

**Pocketbook of Refrigeration and Ice Making. By A. J. WALLIS-TAYLOR.**

This is one of the latest and most comprehensive reference books published on the subject of refrigeration and cold storage. It explains the properties and refrigerating effect of the different fluids in use, the management of refrigerating machinery and the construction and insulation of cold rooms with their required pipe surface for different degrees of cold; freezing mixtures and non-freezing brines, temperatures of cold rooms for all kinds of provisions, cold storage charges for all classes of goods, ice making and storage of ice, data and memoranda for constant reference by refrigerating engineers, with nearly one hundred tables containing valuable references to every fact and condition required in the installment and operation of a refrigerating plant. New edition just published. Price . . . \$1.50

**INVENTIONS—PATENTS**

**Inventors' Manual: How to Make a Patent Pay.**

This is a book designed as a guide to inventors in perfecting their inventions, taking out their patents and disposing of them. It is not in any sense a Patent Solicitor's Circular or a Patent Broker's Advertisement. No advertisements of any description appear in the work. It is a book containing a quarter of a century's experience of a successful inventor, together with notes based upon the experience of many other inventors.

Among the subjects treated in this work are: How to Invent. How to Secure a Good Patent. Value of Good Invention. How to Exhibit an Invention. How to Interest Capital. How to Estimate the Value of a Patent. Value of Design Patents. Value of Foreign Patents. Value of Small Inventions. Advice on Selling Patents. Advice on the Formation of Stock Companies. Advice on the Formation of Limited Liability Companies. Advice on Disposing of Old Patents. Advice as to Patent Attorneys. Advice as to Selling Agents. Forms of Assignments. License and Contracts. State Laws Concerning Patent Rights. 1000 Census of the United States by Counts of Over 10,000 Population. Revised Edition. 120 pages. Price . . . \$1.00

**KNOTS**

**Knots, Splices and Rope Work. By A. HYATT VERRILL.**

This is a practical book giving complete and simple directions for making all the most useful and ornamental knots in common use, with chapters on Splicing, Pointing, Seizing, Servicing, etc. This book is fully illustrated with 154 original engravings, which show how each knot, tie or splice is formed, and its appearance when finished. The book will be found of the greatest value to Campers, Yachtsmen, Travelers, Boy Scouts, in fact, to anyone having occasion to use or handle rope or knots for any purpose. The book is thoroughly reliable and practical, and is not only a guide, but a teacher. It is the standard work on the subject. Among the contents are: 1. Cordage, Kinds of Rope. Construction of Rope, Parts of Rope Cable and Bolt Rope. Strength of Rope, Weight of Rope. 2. Simple Knots and Bends. Terms Used in Handling Rope. Seizing Rope. 3. Ties and Hitches. 4. Noose, Loops and Mooring Knots. 5. Shortenings, Grommets and Salvages. 6. Lashings, Seizings and Splices. 7. Fancy Knots and Rope Work. 128 pages, 150 original engravings. 2nd Revised Edition. Price . . . 75 cents

**LATHE WORK**

**Lathe Design, Construction, and Operation, with Practical Examples of Lathe Work. By OSCAR E. PERRIGO.**

A new, revised edition, and the only complete American work on the subject, written by a man who knows not only how work ought to be done, but who also knows how to do it, and how to convey this knowledge to others. It is strictly up-to-date in its descriptions and illustrations. Lathe history and the relations of the lathe to manufacturing are given; also a description of the various devices for feeds and thread-cutting mechanisms from early efforts in this direction to the present time. Lathe design is thoroughly discussed, including back gearing, driving cones, thread-cutting gears, and all the essential elements of the modern lathe. The classification of lathes is taken up, giving the essential differences of the several types of lathes including, as is usually understood, engine lathes, bench lathes, speed lathes, forge lathes, gap lathes, pulley lathes, forming lathes, multiple-spindle lathes, rapid-reduction lathes, precision lathes, turret lathes, special lathes, electrically driven lathes,

etc. In addition to the complete exposition on construction and design, much practical matter on lathe installation, care and operation has been incorporated in the enlarged new edition. All kinds of lathe attachments for drilling, milling, etc., are described and complete instructions are given to enable the novice machinist to grasp the art of lathe operation as well as the principles involved in design. A number of difficult machining operations are described at length and illustrated. The new edition has nearly 500 pages and 350 illustrations. Price. . . . . **\$2.50**

**WHAT IS SAID OF THIS BOOK:**

"This is a lathe book from beginning to end, and is just the kind of a book which one delights to consult—a masterly treatment of the subject in hand."—*Engineering News*.  
 "This work will be of exceptional interest to any one who is interested in lathe practice, as one very seldom sees such a complete treatise on a subject as this is on the lathe."—*Canadian Machinery*.

**Practical Metal Turning.** By JOSEPH G. HORNER.

A work of 404 pages, fully illustrated, covering in a comprehensive manner the modern practice of machining metal parts in the lathe, including the regular engine lathe, its essential design, its uses, its tools, its attachments, and the manner of holding the work and performing the operations. The modernised engine lathe, its methods, tools and great range of accurate work. The turret lathe, its tools, accessories and methods of performing its functions. Chapters on special work, grinding, tool holders, speeds, feeds, modern tool steels, etc. Second edition . . . . . **\$3.50**

**Turning and Boring Tapers.** By FRED H. COLVIN.

There are two ways to turn tapers; the right way and one other. This treatise has to do with the right way; it tells you how to start the work properly, how to set the lathe, what tools to use and how to use them, and forty and one other little things that you should know. Fourth edition . . . . . **25 cents**

**LIQUID AIR**

**Liquid Air and the Liquefaction of Gases.** By T. O'CONNOR SLOANE.

This book gives the history of the theory, discovery and manufacture of Liquid Air, and contains an illustrated description of all the experiments that have excited the wonder of audiences all over the country. It shows how liquid air, like water, is carried hundreds of miles and is handled in open buckets. It tells what may be expected from it in the near future.

A book that renders simple one of the most perplexing chemical problems of the century. Startling developments illustrated by actual experiments. It is not only a work of scientific interest and authority, but is intended for the general reader, being written in a popular style—easily understood by every one. Second edition. 365 pages. Price. . . . . **\$2.00**

**LOCOMOTIVE ENGINEERING**

**Air-Brake Catechism.** By ROBERT H. BLACKALL.

This book is a standard text-book. It covers the Westinghouse Air-Brake Equipment, including the No. 5 and the No. 6 E.-T. Locomotive Brake Equipment; the K (Quick Service) Triple Valve for Freight Service; and the Cross-Compound Pump. The operation of all parts of the apparatus is explained in detail, and a practical way of finding their peculiarities and defects, with a proper remedy, is given. It contains 2,000 questions with their answers, which will enable any railroad man to pass any examination on the subject of Air Brakes. Endorsed and used by air-brake instructors and examiners on nearly every railroad in the United States. Twenty-sixth edition. 411 pages, fully illustrated with colored plates and diagrams. Price. . . . . **\$2.00**

**American Compound Locomotives.** By FRED H. COLVIN.

The only book on compounds for the engineman or shopman that shows in a plain, practical way the various features of compound locomotives in use. Shows how they are made, what to do when they break down or balk. Contains sections as follows: A Bit of History. Theory of Compounding Steam Cylinders. Baldwin Two-Cylinder Compound. Pittsburg Two-Cylinder Compound. Rhode Island Compound. Richmond Compound. Rogers Compound. Schenectady Two-Cylinder Compound. Vauclain Compound. Tandem Compounds. Baldwin Tandem. The Colvin-Wightman Tandem. Schenectady Tandem. Balanced Locomotives. Baldwin Balanced Compound. Plans for Balancing. Locating Blows. Breakdowns. Reducing Valves. Drifting. Valve Motion. Disconnecting. Power of Compound Locomotives. Practical Notes. Fully illustrated and containing ten special "Duotone" inserts on heavy Plate Paper, showing different types of Compounds. 142 pages. Price. . . . . **\$1.00**

**Application of Highly Superheated Steam to Locomotives.** By ROBERT GARBE.

A practical book which cannot be recommended too highly to those motive-power men who are anxious to maintain the highest efficiency in their locomotives. Contains special chapters on Generation of Highly Superheated Steam; Superheated Steam and the Two-Cylinder Simple Engine; Compounding and Superheating; Designs of Locomotive Superheaters; Constructive Details of Locomotives Using Highly Superheated Steam. Experimental and Working Results. Illustrated with folding plates and tables. Cloth. Price . . . . . **\$2.50**

**Combustion of Coal and the Prevention of Smoke.** By WM. M. BARR.

This book has been prepared with special reference to the generation of heat by the combustion of the common fuels found in the United States and deals particularly with the conditions necessary to the economic and smokeless combustion of bituminous coal in Stationary and Locomotive Steam Boilers. Presentation of this important subject is systematic and progressive. The arrangement of the book is in a series of practical questions to which are appended accurate answers, which describe in language free from technicalities the several processes involved in the furnace combustion of American fuels; it clearly states the essential requisites for perfect combustion, and points out the best methods of furnace construction for obtaining the greatest quantity of heat from any given quality of coal. Nearly 350 pages, fully illustrated. Price . . . . . **\$1.00**

**Diary of a Round-House Foreman.** By T. S. REILLY.

This is the greatest book of railroad experiences ever published. Containing a fund of information and suggestions along the line of handling men, organizing, etc., that one cannot afford to miss. 176 pages. Price . . . . . **\$1.00**

**Link Motions, Valves and Valve Setting.** By FRED H. COLVIN, Associate Editor of "American Machinist."

A handy book for the engineer or machinist that clears up the mysteries of valve setting. Shows the different valve gears in use, how they work, and why. Piston and slide valves of different types are illustrated and explained. A book that every railroad man in the motive-power department ought to have. Contains chapters on Locomotive Link Motion, Valve Movements, Setting Slide Valves, Analysis by Diagrams, Modern Practice, Slip of Block, Slice Valves, Piston Valves, Setting Piston Valves, Joy-Allen Valve Gear, Walschaert Valve Gear, Gooch Valve Gear, Alfree-Hubbell Valve Gear, etc., etc. Fully illustrated. Price . . . . . **50 cents**

**Locomotive Boiler Construction.** By FRANK A. KLEINHANS.

The construction of boilers in general is treated and, following this, the locomotive boiler is taken up in the order in which its various parts go through the shop. Shows all types of boilers used; gives details of construction; practical facts, such as life of riveting, punches and dies; work done per day, allowance for bending and flanging sheets and other data. Including the recent Locomotive Boiler Inspection Laws and Examination Questions with their answers for Government Inspectors. Contains chapters on Laying-Out Work; Flanging and Forging; Punching; Shearing; Plate Planing; General Tables; Finishing Parts; Bending; Machinery Parts; Riveting; Boiler Details; Smoke-Box Details; Assembling and Calking; Boiler-Shop Machinery, etc., etc. There isn't a man who has anything to do with boiler work, either new or repair work, who doesn't need this book. The manufacturer, superintendent, foreman and boiler worker—all need it. No matter what the type of boiler, you'll find a mint of information that you wouldn't be without. Over 400 pages, five large folding plates. Price . . . . . **\$3.00**

**Locomotive Breakdowns and their Remedies.** By GEO. L. FOWLER. Revised by WM. W. WOOD, Air-Brake Instructor. Just issued Revised pocket edition.

It is out of the question to try and tell you about every subject that is covered in this pocket edition of Locomotive Breakdowns. Just imagine all the common troubles that an engineer may expect to happen some time, and then add all of the unexpected ones, troubles that could occur, but that you have never thought about, and you will find that they are all treated with the very best methods of repair. Walschaert Locomotive Valve Gear Troubles, Electric Headlight Troubles, as well as Questions and Answers on the Air Brake are all included. 312 pages. 8th Revised Edition. Fully illustrated. Price . . . . . **\$1.00**

**Locomotive Catechism.** By ROBERT GRIMSHAW.

The revised edition of "Locomotive Catechism," by Robert Grimshaw, is a New Book from Cover to Cover. It contains twice as many pages and double the number of illustrations of previous editions. Includes the greatest amount of practical information ever published on the construction and management of modern locomotives. Specially Prepared Chapters on the Walschaert Locomotive Valve Gear, the Air-Brake Equipment and the Electric Headlight are given.

It commends itself at once to every Engineer and Fireman, and to all who are going in for examination or promotion. In plain language, with full, complete answers, not only all the questions asked by the examining engineer are given, but those which the young and less experienced would ask the veteran, and which old hands ask as "stickers." It is a veritable Encyclopedia of the Locomotive, is entirely free from mathematics, easily understood and thoroughly up to date. Contains over 4,000 Examination Questions with their Answers. 825 pages, 437 illustrations, and 3 folding plates. 28th Revised Edition. Price..... **\$2.50**

**Practical Instructor and Reference Book for Locomotive Firemen and Engineers.** By CHAS. F. LOCKHART.

An entirely new book on the Locomotive. It appeals to every railroad man, as it tells him how things are done and the right way to do them. Written by a man who has had years of practical experience in locomotive shops and on the road firing and running. The information given in this book cannot be found in any other similar treatise. Eight hundred and fifty-one questions with their answers are included, which will prove specially helpful to those preparing for examination. Practical information on: The Construction and Operation of Locomotives, Breakdowns and their Remedies, Air Brakes and Valve Gears. Rules and Signals are handled in a thorough manner. As a book of reference it cannot be excelled. The book is divided into six parts, as follows: 1. The Fireman's Duties. 2. General Description of the Locomotive. 3. Breakdowns and their Remedies. 4. Air Brakes. 5. Extracts from Standard Rules. 6. Questions for Examination. The 851 questions have been carefully selected and arranged. These cover the examinations required by the different railroads. 363 pages, 88 illustrations. Price ..... **\$1.50**

**Prevention of Railroad Accidents, or Safety in Railroading.** By GEORGE BRADSHAW.

This book is a heart-to-heart talk with Railroad Employees, dealing with facts, not theories, and showing the men in the ranks, from every-day experience, how accidents occur and how they may be avoided. The book is illustrated with seventy original photographs and drawings showing the safe and unsafe methods of work. No visionary schemes, no ideal pictures. Just Plain Facts and Practical Suggestions are given. Every railroad employee who reads the book is a better and safer man to have in railroad service. It gives just the information which will be the means of preventing many injuries and deaths. All railroad employees should procure a copy, read it, and do their part in preventing accidents. 169 pages. Pocket size. Fully illustrated. Price..... **50 cents**

**Train Rule Examinations Made Easy.** By G. E. COLLINGWOOD.

This is the only practical work on train rules in print. Every detail is covered, and puzzling points are explained in simple, comprehensive language, making it a practical treatise for the Train Dispatcher, Engineman, Trainman, and all others who have to do with the movements of trains. Contains complete and reliable information of the Standard Code of Train Rules for single track. Shows Signals in Colors, as used on the different roads. Explains fully the practical application of train orders, giving a clear and definite understanding of all orders which may be used. The meaning and necessity for certain rules are explained in such a manner that the student may know beyond a doubt the rights conferred under any orders he may receive or the action required by certain rules. As nearly all roads require trainmen to pass regular examinations, a complete set of examination questions, with their answers, are included. These will enable the student to pass the required examinations with credit to himself and the road for which he works. 2nd Edition, Revised. 256 pages, fully illustrated, with Train Signals in Colors. Price..... **\$1.25**

**The Walschaert and Other Modern Radial Valve Gears for Locomotives.** By WM. W. WOOD.

If you would thoroughly understand the Walschaert Valve Gear you should possess a copy of this book, as the author takes the plainest form of a steam engine—a stationary engine in the rough, that will only turn its crank in one direction—and from it builds up, with the reader's help, a modern locomotive equipped with the Walschaert Valve Gear, complete. The points discussed are clearly illustrated: Two large folding plates that show the positions of the valves of both inside or outside admission type, as well as the links and other parts of the gear when the crank is at nine different points in its revolution, are especially valuable in making the movement clear. These employ sliding cardboard models which are contained in a pocket in the cover.

The book is divided into five general divisions, as follows: 1. Analysis of the gear. 2. Designing and erecting the gear. 3. Advantages of the gear. 4. Questions and answers relating to the Walschaert Valve Gear. 5. Setting valves with the Walschaert Valve Gear; the three primary types of locomotive valve motion; modern radial valve gears other than the Walschaert; the Hobart All-free Valve and Valve Gear, with questions and answers on breakdowns; the Baker-Pilliod Valve Gear; the Improved Baker-Pilliod Valve Gear, with questions and answers on breakdowns.

The questions with full answers given will be especially valuable to firemen and engineers in preparing for an examination for promotion. 245 pages. 3rd Revised Edition. Price **\$1.60**

**Westinghouse E-T Air-Brake Instruction Pocket Book.** By WM. W. WOOD, Air-Brake Instructor.

Here is a book for the railroad man, and the man who aims to be one. It is without doubt the only complete work published on the Westinghouse E-T Locomotive Brake Equipment. Written by an Air-Brake Instructor who knows just what is needed. It covers the subject thoroughly. Everything about the New Westinghouse Engine and Tender Brake Equipment, including the standard No. 5 and the Perfected No. 6 style of brake, is treated in detail. Written in plain English and profusely illustrated with Colored Plates, which enable one to trace the flow of pressures throughout the entire equipment. The best book ever published on the Air Brake. Equally good for the beginner and the advanced engineer. Will pass any one through any examination. It informs and enlightens you on every point. Indispensable to every engineman and trainman.

Contains examination questions and answers on the E-T equipment. Covering what the E-T Brake is. How it should be operated. What to do when defective. Not a question can be asked of the engineman up for promotion, on either the No. 5 or the No. 6 E-T equipment, that is not asked and answered in the book. If you want to thoroughly understand the E-T equipment get a copy of this book. It covers every detail. Makes Air-Brake troubles and examinations easy. Price..... **\$1.50**

**MACHINE-SHOP PRACTICE**

**American Tool Making and Interchangeable Manufacturing.** By J. V. WOODWORTH.

A "shoppy" book, containing no theorising, no problematical or experimental devices. There are no badly proportioned and impossible diagrams, no catalogue cuts, but a valuable collection of drawings and descriptions of devices, the rich fruits of the author's own experience. In its 500-odd pages the one subject only, Tool Making, and whatever relates thereto, is dealt with. The work stands without a rival. It is a complete, practical treatise, on the art of American Tool Making and system of interchangeable manufacturing as carried on to-day in the United States. In it are described and illustrated all of the different types and classes of small tools, fixtures, devices, and special appliances which are in general use in all machine-manufacturing and metal-working establishments where economy, capacity, and interchangeability in the production of machined metal parts are imperative. The science of jig making is exhaustively discussed, and particular attention is paid to drill jigs, boring, profiling and milling fixtures and other devices in which the parts to be machined are located and fastened within the contrivances. All of the tools, fixtures, and devices illustrated and described have been or are used for the actual production of work, such as parts of drill presses, lathes, patented machinery, typewriters, electrical apparatus, mechanical appliances, brass goods, composition parts, mould products, sheet-metal articles, drop-forgings, jewelry, watches, medals, coins, etc. 331 pages. Price..... **\$4.00**

**HENLEY'S ENCYCLOPEDIA OF PRACTICAL ENGINEERING AND ALLIED TRADES.** EDITED BY JOSEPH G. HORNER, A.M.I., M.E.

This set of five volumes contains about 2,500 pages with thousands of illustrations, including diagrammatic and sectional drawings with full explanatory details. This work covers the entire practice of Civil and Mechanical Engineering. The best known experts in all branches of engineering have contributed to these volumes. The Cyclopedic is admirably well adapted to the needs of the beginner and the self-taught practical man, as well as the mechanical engineer, designer, draftsman, shop superintendent, foreman, and machinist. The work will be found a means of advancement to any progressive man. It is encyclopedic in scope, thorough and practical in its treatment on technical subjects, simple and clear in its descriptive matter, and without unnecessary technicalities or formulae. The articles are as brief as may be and yet give a reasonably clear and explicit statement of the subject, and are written by men who have had ample practical experience in the matters of which they write. It tells you all you want to know about engineering and tells it so simply, so clearly, so concisely, that one cannot help but understand. As a work of reference it is without a peer. Complete set of five volumes, price..... **\$25.00**

**The Modern Machinist.** By JOHN T. USHER.

This is a book, showing by plain description and by profuse engravings made expressly for the work, all that is best, most advanced, and of the highest efficiency in modern machine-shop practice, tools and implements, showing the way by which and through which, as Mr. Maxim says, "American machinists have become and are the finest mechanics in the world." Indicating as it does, in every line, the familiarity of the author with every detail of daily experience in the shop, it cannot fail to be of service to any man practically connected with the shaping or finishing of metals.

There is nothing experimental or visionary about the book, all devices being in actual use and giving good results. It might be called a compendium of shop methods, showing a variety of special tools and appliances which will give new ideas to many mechanics, from the superintendent down to the man at the bench. It will be found a valuable addition to any machinist's library, and should be consulted whenever a new or difficult job is to be done, whether it is boring, milling, turning, or planing, as they are all treated in a practical manner. Fifth edition. 320 pages. 250 illustrations. Price..... **\$2.50**

**THE WHOLE FIELD OF MECHANICAL MOVEMENTS COVERED BY MR. HISCOX'S TWO BOOKS**

We publish two books by Gardner D. Hiscox that will keep you from "inventing" things that have been done before, and suggest ways of doing things that you have not thought of before. Many a man spends time and money, endeavoring over some mechanical problem, only to learn, after he has solved the problem, that the same thing has been accomplished and put in practice by others long before. Time and money spent in an effort to accomplish what has already been accomplished, are time and money lost. The whole field of mechanics, every known mechanical movement, and practically every device ever used, are described in these two books. If the thing you want has been invented, it is illustrated in them. If it hasn't been invented, then you'll find in them the nearest things to what you want, some movements or devices that will apply in your case, perhaps; or which will give you a key from which to work. No book or set of books ever published is of more real value to the Inventor, Draftsman, or practical Mechanic than the two volumes described below.

**Mechanical Movements, Powers, and Devices.** By GARDNER D. HISCOX.

This is a collection of 1,500 engravings of different mechanical motions and appliances, accompanied by appropriate text, making it a book of great value to the inventor, the draftsman, and to all readers with mechanical tastes. The book is divided into eighteen sections or chapters, in which the subject-matter is classified under the following heads: Mechanical Powers; Transmission of Power; Measurement of Power; Steam Power; Air Power Appliances; Electric Power and Construction; Navigation and Roads; Gearing; Motion and Devices; Controlling Motion; Horological; Mining; Mill and Factory Appliances; Construction and Devices; Drafting Devices; Miscellaneous Devices, etc. 15th Edition. 400 octavo pages. Price **\$3.00**

**Mechanical Appliances, Mechanical Movements and Novelties of Construction.** By GARDNER D. HISCOX.

This is a supplementary volume to the one upon mechanical movements. Unlike the first volume, which is more elementary in character, this volume contains illustrations and descriptions of many combinations of motions and of mechanical devices and appliances found in different lines of machinery, each device being shown by a line drawing with a description showing its working parts and the method of operation. From the multitude of devices described and illustrated might be mentioned, in passing, such items as conveyors and elevators, Pony brakes, thermometers, various types of boilers, solar engines, oil-fuel burners, condensers, evaporators, Corliss and other valve gears, governors, gas engines, water motors of various descriptions, air ships, motors and dynamos, automobile and motor bicycles, railway lock signals, car couplers, link and gear motions, ball bearings, breech-block mechanism for heavy guns, and a large accumulation of others of equal importance. One thousand specially made engravings. 396 octavo pages. Fourth edition. Price **\$3.00**

**Machine-Shop Tools and Shop Practice.** By W. H. VANDERVOORT.

A work of 555 pages and 673 illustrations, describing in every detail the construction, operation and manipulation of both hand and machine tools. Includes chapters on filing, fitting and scraping surfaces; on drills, reamers, taps and dies; the lathe and its tools; planers, shapers, and their tools; milling machines and cutters; gear cutters and gear cutting; drilling machines and drill work; grinding machines and their work; hardening and tempering; gearing, belting and transmission machinery; useful data and tables. Sixth edition. Price **\$3.00**

**Machine-Shop Arithmetic.** By COLVIN-CHENEY.

This is an arithmetic of the things you have to do with daily. It tells you plainly about: how to find areas in figures; how to find surface or volume of balls or spheres; handy ways for calculating; about compound gearing; cutting screw threads on any lathe; drilling for taps; speeds of drills; taps, emery wheels, grindstones, milling cutters, etc.; all about the Metric system with conversion tables; properties of metals; strength of bolts and nuts; decimal equivalents of an inch. All sorts of machine-shop figuring and 1,001 other things, any one of which ought to be worth more than the price of this book to you, as it saves you the trouble of bothering the boss. 6th Edition. 131 pages. Price **50 cents**

**Modern Machine-Shop Construction, Equipment and Management.** By OSCAR E. FERRIGO.

The only work published that describes the Modern Shop or Manufacturing Plant from the time the grass is growing on the site intended for it until the finished product is shipped. Just the book needed by those contemplating the erection of modern shop buildings, the rebuilding and reorganization of old ones, or the introduction of Modern Shop Methods, time and cost systems. It is a book written and illustrated by a practical shop man for practical shop men who are too busy to read theories and want facts. It is the most complete all-round book of its kind ever published. Second Edition, Revised. 384 large quarto pages. 219 original and specially made illustrations. 2nd Revised and Enlarged Edition. Price **\$5.00**



**Modern Milling Machines: Their Design, Construction, and Operation.**

By JOSEPH G. HORNER.

This book describes and illustrates the Milling Machine and its work in such a plain, clear and forceful manner, and illustrates the subject so clearly and completely, that the up-to-date machinist, student or mechanical engineer cannot afford to do without the valuable information which it contains. It describes not only the early machines of this class, but notes their gradual development into the splendid machines of the present day, giving the design and construction of the various types, forms, and special features produced by prominent manufacturers, American and foreign. 304 pages, 300 illustrations. Cloth. Price... **\$4.00**

**"Shop Kinks."** By ROBERT GRIMSHAW.

A book of 400 pages and 222 illustrations, being entirely different from any other book on machine-shop practice. Departing from conventional style, the author avoids universal or common shop usage and limits his work to showing special ways of doing things better, more cheaply and more rapidly than usual. As a result the advanced methods of representative establishments of the world are placed at the disposal of the reader. This book shows the proprietor where large savings are possible, and how products may be improved. To the employee it holds out suggestions that, properly applied, will hasten his advancement. No shop can afford to be without it. It bristles with valuable wrinkles and helpful suggestions. It will benefit all, from apprentice to proprietor. Every machinist, at any age, should study its pages. Fifth edition. Price..... **\$2.50**

**Threads and Thread Cutting.** By COLVIN and STABEL.

This clears up many of the mysteries of thread-cutting, such as double and triple threads, internal threads, catching threads, use of hobs, etc. Contains a lot of useful hints and several tables. Third edition. Price..... **25 cents**

**MANUAL TRAINING**

**Economies of Manual Training.** By LOUIS ROUILLION.

The only book published that gives just the information needed by all interested in Manual Training, regarding Buildings, Equipment, and Supplies. Shows exactly what is needed for all grades of the work from the Kindergarten to the High and Normal School. Gives itemized lists of everything used in Manual Training Work and tells just what it ought to cost. Also shows where to buy supplies, etc. Contains 174 pages, and is fully illustrated. Second edition. Price..... **\$1.50**

**MARINE ENGINEERING**

**The Naval Architect's and Shipbuilder's Pocket Book of Formulæ, Rules, and Tables and Marine Engineer's and Surveyor's Handy Book of Reference.** By CLEMENT MACKROW and LLOYD WOOLLARD.

The eleventh Revised and Enlarged Edition of this most comprehensive work has just been issued. It is absolutely indispensable to all engaged in the Shipbuilding Industry, as it condenses into a compact form all data and formulæ that are ordinarily required. The book is completely up-to-date, including among other subjects a section on Aeronautics. 750 pages, limp leather binding. Price..... **\$5.00 net**

**Marine Engines and Boilers: Their Design and Construction.** By DR. G. BAUER, LESLIE S. ROBERTSON and S. BRYAN DONKIN.

In the words of Dr. Bauer, the present work owes its origin to an oft felt want of a condensed treatise embodying the theoretical and practical rules used in designing marine engines and boilers. The need of such a work has been felt by most engineers engaged in the construction and working of marine engines, not only by the younger men, but also by those of greater experience. The fact that the original German work was written by the chief engineer of the famous Vulcan Works, Stettin, is in itself a guarantee that this book is in all respects thoroughly up-to-date, and that it embodies all the information which is necessary for the design and construction of the highest types of marine engines and boilers. It may be said that the motive power which Dr. Bauer has placed in the fast German liners that have been turned out of late years from the Stettin Works represent the very best practice in marine engineering of the present day. The work is clearly written, thoroughly systematic, theoretically sound; while the character of the plans, drawings, tables, and statistics is without reproach. The illustrations are careful reproductions from actual working drawings, with some well-executed photographic views of completed engines and boilers. 744 pages, 550 illustrations and numerous tables. Cloth. Price..... **\$9.00 net**

**MINING**

**Ore Deposits, with a Chapter on Hints to Prospectors.** By J. P. JOHNSON.

This book gives a condensed account of the ore deposits at present known in South Africa. It is also intended as a guide to the prospector. Only an elementary knowledge of geology and some mining experience are necessary in order to understand this work. With these qualifications, it will materially assist one in his search for metalliferous mineral occurrences and, so far as simple ores are concerned, should enable one to form some idea of the possibilities of any he may find. Illustrated. Cloth. Price ..... **\$2.00**

**Practical Coal Mining.** By T. H. COCKIN.

An important work, containing 428 pages and 213 illustrations, complete with practical details, which will intuitively impart to the reader not only a general knowledge of the principles of coal mining, but also considerable insight into allied subjects. The treatise is positively up-to-date in every instance, and should be in the hands of every colliery engineer, geologist, mine operator, superintendent, foreman, and all others who are interested in or connected with the industry. 3d Edition. Cloth. Price ..... **\$2.50**

**Physics and Chemistry of Mining.** By T. H. BYROM.

A practical work for the use of all preparing for examinations and entirely practical treatise on colliery managers' certificates. The aim of the author in this excellent book is to place clearly before the reader useful and authoritative data which will render him valuable assistance in his studies. The only work of its kind published. The information incorporated in it will prove of the greatest practical utility to students, mining engineers, colliery managers, and all others who are specially interested in the present-day treatment of mining problems. 160 pages, illustrated. Price ..... **\$2.00**

**PATTERN MAKING**

**Practical Pattern Making.** By F. W. BARROWS.

This book, now in its second edition, is a comprehensive and entirely practical treatise on the subject of pattern making, illustrating pattern work in both wood and metal, and with definite instructions on the use of plaster of paris in the trade. It gives specific and detailed descriptions of the materials used by pattern makers, and describes the tools, both those for the bench and the more interesting machine tools, having complete chapters on the Lathe, the Circular Saw, and the Band Saw. It gives many examples of pattern work, each one fully illustrated and explained with much detail. These examples, in their great variety, offer much that will be found of interest to all pattern makers, and especially to the younger ones, who are seeking information on the more advanced branches of their trade.

In this second edition of the work will be found much that is new, even to those who have long practised this exacting trade. In the description of patterns as adapted to the Moulding Machine many difficulties which have long prevented the rapid and economical production of castings are overcome; and this great, new branch of the trade is given much space. Stripping plate and stool plate work and the less expensive vibrator, or rapping plate work, are all explained in detail.

Plain, every-day rules for lessening the cost of patterns, with a complete system of cost keeping, a detailed method of marking, applicable to all branches of the trade, with complete information showing what the pattern is, its specific title, its cost, date of production, material of which it is made, the number of pieces and core-boxes, and its location in the pattern safe, all condensed into a most complete card record, with cross index.

The book closes with an original and practical method for the inventory and valuation of patterns. Containing nearly 350 pages and 170 illustrations. Price . . . . . **\$2.00**

**PERFUMERY**

**Perfumes and Cosmetics: Their Preparation and Manufacture.** By G. W. ASKINSON, Perfumer.

A comprehensive treatise, in which there has been nothing omitted that could be of value to the perfumer or manufacturer of toilet preparations. Complete directions for making handkerchief perfumes, smelling-salts, sachets, fumigating pastilles; preparations for the care of the skin, the mouth, the hair, cosmetics, hair dyes and other toilet articles are given, also a detailed description of aromatic substances; their nature, tests of purity, and wholesome manufacture, including a chapter on synthetic products, with formulas for their use. A book of general as well as professional interest, meeting the wants not only of the druggist and perfume manufacturer, but also of the general public. Among the contents are:

1. The History of Perfumery.
2. About Aromatic Substances in General.
3. Odors from the Vegetable Kingdom.
4. The Aromatic Vegetable Substances Employed in Perfumery.
5. The Animal Substances Used in Perfumery.
6. The Chemical Products Used in Perfumery.
7. The Extraction of Odors.
8. The Special Characteristics of Aromatic Substances.
9. The Adulteration of Essential Oils and Their Recognition.
10. Synthetic Products.
11. Table of Physical Properties of Aromatic Chemicals.
12. The Essences or Extracts Employed in Perfumery.
13. Directions for Making the Most Important Essences and Extracts.

14. The Division of Perfumery. 15. The Manufacture of Handkerchief Perfumes. 16. Formulas for Handkerchief Perfumes. 17. Ammoniacal and Acid Perfumes. 18. Dry Perfumes. 19. Formulas for Dry Perfumes. 20. The Perfumes Used for Fumigation. 21. Antiseptic and Therapeutic Value of Perfumes. 22. Classification of Odors. 23. Some Special Perfumery Products. 24. Hygiene and Cosmetic Perfumery. 25. Preparations for the Care of the Skin. 26. Manufacture of Casein. 27. Formulas for Emulsions. 28. Formulas for Cream. 29. Formulas for Meals, Pastes and Vegetable Milk. 30. Preparations Used for the Hair. 31. Formulas for Hair Tonics and Restorers. 32. Pomades and Hair Oils. 33. Formulas for the Manufacture of Pomades and Hair Oils. 34. Hair Dyes and Depilatories. 35. Wax Pomades, Bandolines and Brilliantines. 36. Skin Cosmetics and Face Lotions. 37. Preparations for the Nails. 38. Water Softeners and Bath Salts. 39. Preparations for the Care of the Mouth. 40. The Colors Used in Perfumery. 41. The Utensils Used in the Toilet. Fourth edition, much enlarged and brought up to date. Nearly 400 pages, illustrated. Price. **\$5.00**

#### WHAT IS SAID OF THIS BOOK:

"The most satisfactory work on the subject of Perfumery that we have ever seen."  
 "We feel safe in saying that here is a book on Perfumery that will not disappoint you, for it has practical and excellent formulae that are within your ability to prepare readily."  
 "We recommend the volume as worthy of confidence, and say that no purchaser will be disappointed in securing from its pages good value for its cost, and a large dividend on the same, even if he should use but one per cent. of its working formulae. There is money in it for every user of its information."—*Pharmaceutical Record.*

## PLUMBING

### Mechanical Drawing for Plumbers. By R. M. STARBUCK.

A concise, comprehensive and practical treatise on the subject of mechanical drawing in its various modern applications to the work of all who are in any way connected with the plumbing trade. Nothing will so help the plumber in estimating and in explaining work to customers and workmen as a knowledge of drawing, and to the workman it is of inestimable value if he is to rise above his position to positions of greater responsibility. Among the chapters contained are: 1. Value to plumber of knowledge of drawing; tools required and their use; common views needed in mechanical drawing. 2. Perspective versus mechanical drawing in showing plumbing construction. 3. Correct and incorrect methods in plumbing drawing; plan and elevation explained. 4. Floor and cellar plans and elevation; scale drawings; use of triangles. 5. Use of triangles; drawing of fittings, traps, etc. 6. Drawing plumbing elevations and fittings. 7. Instructions in drawing plumbing elevations. 8. The drawing of plumbing fixtures; scale drawings. 9. Drawings of fixtures and fittings. 10. Inking of drawings. 11. Shading of drawings. 12. Shading of drawings. 13. Sectional drawings; drawing of threads. 14. Plumbing elevations from architect's plan. 15. Elevations of separate parts of the plumbing system. 16. Elevations from the architect's plans. 17. Drawings of detail plumbing connections. 18. Architect's plans and plumbing elevations of residence. 19. Plumbing elevations of residence (continued); plumbing plans for cottage. 20. Plumbing elevations; roof connections. 21. Plans and plumbing elevations for six-flat building. 22. Drawing of various parts of the plumbing system; use of scales. 23. Use of architect's scales. 24. Special features in the illustrations of country plumbing. 25. Drawing of wrought-iron piping, valves, radiators, coils, etc. 26. Drawing of piping to illustrate heating systems. 150 illustrations. Price **\$1.50**

### Modern Plumbing Illustrated. By R. M. STARBUCK.

This book represents the highest standard of plumbing work. It has been adopted and used as a reference book by the United States Government in its sanitary work in Cuba, Porto Rico and the Philippines, and by the principal Boards of Health of the United States and Canada.

It gives connections, sizes and working data for all fixtures and groups of fixtures. It is helpful to the master plumber in demonstrating to his customers and in figuring work. It gives the mechanic and student quick and easy access to the best modern plumbing practice. Suggestions for estimating plumbing construction are contained in its pages. This book represents, in a word, the latest and best up-to-date practice and should be in the hands of every architect, sanitary engineer and plumber who wishes to keep himself up to the minute on this important feature of construction. Contains following chapters, each illustrated with a full page plate: Kitchen sink; laundry tub; vegetable wash sink; lavatory; water closets; contents of marble slabs; bath tub, foot and sitz bath, shower bath; water closets, venting of water closets; low-down water closets, water closets operated by flush valves, water closet range; slop sink, urinals, the bidet; Hotel and restaurant sink, grease trap; refrigerators, safe wastes, laundry waste, lines of refrigerators, bar sinks, soda fountain sinks; hose stall, frost-proof water closets; connections for S traps, venting; connections for drum traps; soil-pipe connections; supporting of soil pipe; main trap and fresh-air inlet; floor drains and cellar drains, subsoil drainage; water closets and floor connections; local venting; connections for bath rooms; connections for bath rooms, continued; examples of poor practice; roughing work ready for test; testing of plumbing systems; method of continuous venting; continuous venting for two-floor work; continuous venting for two lines of fixtures on three or more floors; continuous venting of water closets; plumbing for cottage house; construction for cellar piping; plumbing for residence, use of special fittings; plumbing for two-story house; plumbing for apartment building; plumbing for double apartment building; plumbing for office building; plumbing for public toilet rooms; plumbing for public toilet rooms, continued; plumbing for bath establishment; plumbing for engine house, factory plumbing; automatic flushing for schools, factories, etc.; use of flushing valves; urinals for public toilet rooms; the Durham system, the destruction of pipes by electrolysis; construction of work

without use of lead; automatic sewage lift; automatic sump tank; country plumbing; construction of cesspools; septic tank and automatic sewage siphon; water supply for country house; thawing of water mains and service by electricity; double boilers; hot water supply of large buildings; automatic control of hot-water tank; suggestions for estimating plumbing construction. 407 octavo pages, fully illustrated by 57 full-page engravings. Third, revised and enlarged edition, just issued. Price \$2.00

**Standard Practical Plumbing, By R. M. STARBUCK.**

A complete practical treatise of 450 pages, covering the subject of Modern Plumbing in all its branches, a large amount of space being devoted to a very complete and practical treatment of the subject of Hot Water Supply and Circulation and Range Boiler Work. Its thirty chapters include about every phase of the subject one can think of, making it an indispensable work to the master plumber, the journeyman plumber, and the apprentice plumber, containing chapters on: the plumber's tools; wiping solder; composition and use; joint wiping; lead work; traps; siphonage of traps; venting; continuous venting; house sewer and sewer connections; house drain; soil piping, roughing; main trap and fresh air inlet; floor, yard, cellar drains, rain leaders, etc.; fixture wastes; water closets; ventilation; improved plumbing connections; residence plumbing; plumbing for hotels, schools, factories, stables, etc.; modern country plumbing; filtration of sewage and water supply; hot and cold supply; range boilers; circulation; circulating pipes; range boiler problems; hot water for large buildings; water lift and its use; multiple connections for hot water boilers; heating of radiation by supply system; theory for the plumber; drawing for the plumber. Fully illustrated by 347 engravings. Price \$3.00

**RECIPE BOOK**

**Henley's Twentieth Century Book of Recipes, Formulas and Processes.**  
 Edited by GARDNER D. HISCOX.

60.18 The most valuable Techno-chemical Formula Book published, including over 10,000 selected scientific, chemical, technological, and practical recipes and processes.

This is the most complete Book of Formulas ever published, giving thousands of recipes for the manufacture of valuable articles for everyday use. Hints, Helps, Practical Ideas, and Secret Processes are revealed. It covers a wide branch of the useful arts and tells thousands of ways of making money, and is just the book everyone should have at his command.

Modern in its treatment of every subject that properly falls within its scope, the book may truthfully be said to present the very latest formulas to be found in the arts and industries, and to retain those processes which long experience has proven worthy of a permanent record.

To present here even a limited number of the subjects which find a place in this valuable work would be difficult. Suffice to say that in its pages will be found matter of intense interest and immeasurably practical value to the scientific amateur and to him who wishes to obtain a full knowledge of the many processes used in the arts, trades, and manufacture, a knowledge which will render his pursuits more instructive and remunerative. Serving as a ready reference book to the small and large manufacturer and supplying intelligent seekers with the information necessary to conduct a process, the work will be found of inestimable worth to the Metallurgist, the Photographer, the Perfumer, the Painter, the Manufacturer of Glues, Pastes, Cements, and Mucilages, the Compounder of Alloys, the Cook, the Physician, the Druggist, the Electrician, the Brewer, the Engineer, the Foundryman, the Machinist, the Potter, the Tanner, the Confectioner, the Chiro-podist, the Manufacturer of Chemical Novelties and Toilet Preparations, the Dyer, the Electroplater, the Enameler, the Engraver, the Provisioner, the Glass Worker, the Goldbeater, the Watchmaker, the Jeweler, the Hat Maker, the Ink Manufacturer, the Optician, the Farmer, the Dairyman, the Paper Mill Maker, the Wood and Metal Worker, the Chandler and Soap Maker, the Veterinary Surgeon, and the Technologist in general.

A mine of information, and up-to-date in every respect. A book which will prove of value to EVERYONE, as it covers every branch of the Useful Arts. Every home needs this book; every office, every factory, every store, every public and private enterprise—EVERYWHERE 60.18—should have a copy. 800 pages. Price \$3.00

**WHAT IS SAID OF THIS BOOK:**

"Your Twentieth Century Book of Recipes, Formulas, and Processes duly received. I am glad to have a copy of it, and if I could not replace it, money couldn't buy it. It is the best thing of the sort I ever saw." (Signed) M. E. TRUX, Spartan, Wis.

There are few persons who would not be able to find in the book some single formula that would repay several times the cost of the book."—*Merchants' Record and Show Window.*

"I purchased your book, 'Henley's Twentieth Century Book of Recipes, Formulas and Processes,' about a year ago and it is worth its weight in gold."—WM. H. MURRAY, Bennington, Vt.

**"ONE OF THE WORLD'S MOST USEFUL BOOKS"**

Some time ago I got one of your 'Twentieth Century Books of Formulas,' and have made my living from it ever since. I am alone since my husband's death with two small children to care for and am trying so hard to support them. I have customers who take from me Toilet Articles I put up, following directions given in the book, and I have found everyone of them to be fine."—Mrs. J. H. McMAKEN, West Toledo, Ohio.

**RUBBER****Rubber Hand Stamps and the Manipulation of India Rubber.** By T. O'CONNOR SLOANE.

This book gives full details on all points, treating in a concise and simple manner the elements of nearly everything it is necessary to understand for a commencement in any branch of the India Rubber Manufacture. The making of all kinds of Rubber Hand Stamps, Small Articles of India Rubber, U. S. Government Composition, Dating Hand Stamps, the Manipulation of Sheet Rubber, Toy Balloons, India Rubber Solutions, Cements, Blackings, Renovating, Varnish, and Treatment for India Rubber Shoes, etc.; the Hektograph Stamp Inks, and Miscellaneous Notes, with a Short Account of the Discovery, Collection and Manufacture of India Rubber, are set forth in a manner designed to be readily understood, the explanations being plain and simple. Including a chapter on Rubber Tire Making and Vulcanizing; also a chapter on the uses of rubber in Surgery and Dentistry. 3rd Revised and Enlarged Edition. 175 pages. Illustrated . . . . . **\$1.00**

**SAWS****Saw Filing and Management of Saws.** By ROBERT GRIMSHAW.

A practical hand-book on filing, gumming, swaging, hammering, and the brasing of band saws, the speed, work, and power to run circular saws, etc. A handy book for those who have charge of saws, or for those mechanics who do their own filing, as it deals with the proper shape and pitches of saw teeth of all kinds and gives many useful hints and rules for gumming, setting, and filing, and is a practical aid to those who use saws for any purpose. Complete tables of proper shape, pitch, and saw teeth as well as sizes and number of teeth of various saws are included. 3rd Edition, Revised and Enlarged. Illustrated. Price. . . . . **\$1.00**

**STEAM ENGINEERING****American Stationary Engineering.** By W. E. CRANE.

This book begins at the boiler room and takes in the whole power plant. A plain talk on every-day work about engines, boilers, and their accessories. It is not intended to be scientific or mathematical. All formulas are in simple form so that any one understanding plain arithmetic can readily understand any of them. The author has made this the most practical book in print; has given the results of his years of experience, and has included about all that has to do with an engine room or a power plant. You are not left to guess at a single point. You are shown clearly what to expect under the various conditions; how to secure the best results; ways of preventing "shut downs" and repairs; in short, all that goes to make up the requirements of a good engineer, capable of taking charge of a plant. It's plain enough for practical men and yet of value to those high in the profession.

A partial list of contents is: The boiler room, cleaning boilers, firing, feeding; pumps, inspection and repair; chimneys, sizes and cost; piping; mason work; foundations; testing cement; pile driving; engines, slow and high speed; valves; valve setting; Corliss engines, setting valves, single and double eccentric; air pumps and condensers; different types of condensers; water needed; lining up; pounds; pins not square in crosshead or crank; engineers' tools; pistons and piston rings; bearing metal; hardened copper; drip pipes from cylinder jacket; belts, how made, care of; oils; greases; testing lubricants; rules and tables, including steam tables; areas of segments; squares and square roots; cubes and cube root; areas and circumferences of circles. Notes on: Brick work; explosions; pumps; pump valves; heaters, economizers; safety valves; lap, lead, and clearance. Has a complete examination for a license, etc., etc. 3rd Edition. 345 pages, illustrated. Price . . . . . **\$2.00**

**Engine Runner's Catechism.** By ROBERT GRIMSHAW.

A practical treatise for the stationary engineer, telling how to erect, adjust, and run the principal steam engines in use in the United States. Describing the principal features of various special and well-known makes of engines: Temper Cut-off, Shipping and Receiving Foundations, Erecting and Starting, Valve Setting, Care and Use, Emergencies, Erecting and Adjusting Special Engines.

The questions asked throughout the catechism are plain and to the point, and the answers are given in such simple language as to be readily understood by anyone. All the instructions given are complete and up-to-date; and they are written in a popular style, without any technicalities or mathematical formulae. The work is of a handy size for the pocket, clearly and well printed, nicely bound, and profusely illustrated.

To young engineers this catechism will be of great value, especially to those who may be preparing to go forward to be examined for certificates of competency; and to engineers generally it will be of no little service, as they will find in this volume more really practical and useful information than is to be found anywhere else within a like compass. 387 pages. 7th Edition. Price . . . . . **\$2.00**

**Modern Steam Engineering in Theory and Practice.** By GARDNER D. HISCOX.

This is a complete and practical work issued for Stationary Engineers and Firemen, dealing with the care and management of boilers, engines, pumps, superheated steam, refrigerating machinery, dynamos, motors, elevators, air compressors, and all other branches with which the modern engineer must be familiar. Nearly 200 questions with their answers on steam and electrical engineering, likely to be asked by the Examining Board, are included. Among the chapters are: Historical: steam and its properties; appliances for the generation of steam; types of boilers; chimney and its work; heat economy of the feed water; steam pumps and their work; incrustation and its work; steam above atmospheric pressure; flow of steam from nozzles; superheated steam and its work; adiabatic expansion of steam; indicator and its work; steam engine proportions; slide valve engines and valve motion; Corliss engine and its valve gear; compound engine and its theory; triple and multiple expansion engine; steam turbine; refrigeration; elevators and their management; cost of power; steam engine troubles; electric power and electric plants. 487 pages, 405 engravings. 3rd Edition. Price . . . . . **\$3.00**

**Steam Engine Catechism.** By ROBERT GRIMSHAW.

This unique volume of 413 pages is not only a catechism on the question and answer principle but it contains formulas and worked-out answers for all the Steam problems that appertain to operation and management of the Steam Engine. Illustrations of various valves and valve gear with their principles of operation are given. Thirty-four Tables that are indispensable to every engineer and fireman that wishes to be progressive and is ambitious to become master of his calling are within its pages. It is a most valuable instructor in the service of Steam Engineering. Leading engineers have recommended it as a valuable educator for the beginner as well as a reference book for the engineer. It is thoroughly indexed for every detail. Every essential question on the Steam Engine with its answer is contained in this valuable work. 16th Edition. Price . . . . . **\$2.00**

**Steam Engineer's Arithmetic.** By COLVIN-CHENEY.

A practical pocket-book for the steam engineer. Shows how to work the problems of the engine room and shows "why." Tells how to figure horsepower of engines and boilers; area of boilers; has tables of areas and circumferences; steam tables; has a dictionary of engineering terms. Puts you on to all of the little kinks in figuring whatever there is to figure around a power plant. Tells you about the heat unit; absolute zero; adiabatic expansion; duty of engines; factor of safety; and a thousand and one other things; and everything is plain and simple—not the hardest way to figure, but the easiest. 2nd Edition. Price . . **50 Cents**

**Engine Tests and Boiler Efficiencies.** By J. BUCHETTI.

This work fully describes and illustrates the method of testing the power of steam engines, turbines and explosive motors. The properties of steam and the evaporative power of fuels. Combustion of fuel and chimney draft; with formulas explained or practically computed. 255 pages, 179 illustrations. Price . . . . . **\$3.00**

**Horsepower Chart.**

Shows the horsepower of any stationary engine without calculation. No matter what the cylinder diameter of stroke, the steam pressure of cut-off, the revolutions, or whether condensing or non-condensing, it's all there. Easy to use, accurate, and saves time and calculations. Especially useful to engineers and designers. Price . . . . . **50 Cents**

**STEAM HEATING AND VENTILATION**

**Practical Steam, Hot-Water Heating and Ventilation.** By A. G. KING.

This book is the standard and latest work published on the subject and has been prepared for the use of all engaged in the business of steam, hot-water heating, and ventilation. It is an original and exhaustive work. Tells how to get heating contracts, how to install heating and ventilating apparatus, the best business methods to be used, with "Tricks of the Trade" for shop use. Rules and data for estimating radiation and cost and such tables and information as make it an indispensable work for everyone interested in steam, hot-water heating, and ventilation. It describes all the principal systems of steam, hot-water, vacuum, vapor, and vacuum-vapor heating, together with the new accelerated systems of hot-water circulation, including chapters on up-to-date methods of ventilation and the fan or blower system of heating and ventilation. Containing chapters on: I. Introduction. II. Heat. III. Evolution of artificial heating apparatus. IV. Boiler surface and settings. V. The chimney flue. VI. Pipe and fittings. VII. Valves, various kinds. VIII. Forms of radiating surfaces. IX.

Location of radiating surfaces. X. Estimating radiation. XI. Steam heating, apparatus. XII. Exhaust-steam heating. XIII. Hot-water heating. XIV. Pressure systems of hot-water work. XV. Hot-water appliances. XVI. Greenhouse heating. XVII. Vacuum vapor and vacuum exhaust heating. XVIII. Miscellaneous heating. XIX. Radiator and pipe connections. XX. Ventilation. XXI. Mechanical ventilation and hot-blast heating. XXII. Steam appliances. XXIII. District heating. XXIV. Pipe and boiler covering. XXV. Temperature regulation and heat control. XXVI. Business methods. XXVII. Miscellaneous. XXVIII. Rules, tables, and useful information. 367 pages, 300 detailed engravings. 2nd Edition—Revised. Price **\$3.00**

### Five Hundred Plain Answers to Direct Questions on Steam, Hot-Water, Vapor and Vacuum Heating Practice. By ALFRED G. KING.

This work, just off the press, is arranged in question and answer form; it is intended as a guide and text-book for the younger, inexperienced fitter and as a reference book for all fitters. This book tells "how" and also tells "why". No work of its kind has ever been published. It answers all the questions regarding each method or system that would be asked by the steam fitter or heating contractor, and may be used as a text or reference book, and for examination questions by Trade Schools or Steam Fitters' Associations. Rules, tables and descriptive methods are given, together with much other detailed information of daily practical use to those engaged in or interested in the various methods of heating. Valuable to those preparing for examinations. Answers every question asked relating to modern Steam, Hot-Water, Vapor and Vacuum Heating. Among the contents are: The Theory and Laws of Heat. Methods of Heating. Chimneys and Flues. Boilers for Heating. Boiler Trimmings and Settings. Radiation. Steam Heating. Boiler, Radiator and Pipe Connections for Steam Heating. Hot Water Heating. The Two-Pipe Gravity System of Hot Water Heating. The Circuit System of Hot Water Heating. The Overhead System of Hot Water Heating. Boiler, Radiator and Pipe Connections for Gravity Systems of Hot Water Heating. Accelerated Hot Water Heating. Expansion Tank Connections. Domestic Hot Water Heating. Valves and Air Valves. Vacuum Vapor and Vacuum Vapor Heating. Mechanical Systems of Vacuum Heating. Non-Mechanical Vacuum Systems. Vapor Systems. Atmospheric and Modulating Systems. Heating Greenhouses. Information, Rules and Tables. 200 pages, 127 illustrations. Octavo. Cloth. Price **\$1.50**

## STEEL

### Steel: Its Selection, Annealing, Hardening, and Tempering. By E. R. MARKHAM.

This work was formerly known as "The American Steel Worker," but on the publication of the new, revised edition, the publisher advised its change to this title, as more suitable one. It is the standard work on Hardening, Tempering, and Annealing Steel of all kinds. This book tells how to select and how to work; temper, harden, and anneal steel for everything on earth. It doesn't tell how to temper one class of tools and then leave the treatment of another kind of tool to your imagination and judgment, but it gives careful instructions for every detail of every tool, whether it be a tap, a reamer or just a screw-driver. It tells about the tempering of small watch springs, the hardening of cutlery, and the annealing of dies. In fact, there isn't a thing that a steel worker would want to know that isn't included. It is the standard book on selecting, hardening and tempering all grades of steel. Among the chapter headings might be mentioned the following subjects: Introduction; the workman; steel; methods of heating; heating tool steel; forging; annealing; hardening baths; baths for hardening; hardening steel; drawing the temper after hardening; examples of hardening; pack hardening; case hardening; spring tempering; making tools of machine steel; special steels; steel for various tools; causes of trouble; high-speed steels; etc. 400 pages. Very fully illustrated. Fourth edition. Price **\$2.50**

### Hardening, Tempering, Annealing, and Forging of Steel. By J. V. WOODWORTH.

A new work treating in a clear, concise manner all modern processes for the heating, annealing, forging, welding, hardening and tempering of steel, making it a book of great practical value to the metal-working mechanic in general, with special directions for the successful hardening and tempering of all steel tools used in the arts, including milling cutters, taps, thread dies, reamers, both solid and shell, hollow mills, punches and dies, and all kinds of sheet-metal working tools, shear blades, saws, fine cutlery, and metal-cutting tools of all description, as well as for all implements of steel both large and small. In this work the simplest and most satisfactory hardening and tempering processes are given. The uses to which the leading brands of steel may be adapted are concisely presented, and their treatment for working under different conditions explained, also the special methods for the hardening and tempering of special brands. A chapter devoted to the different processes for case-hardening is also included, and special reference made to the adaptation of machinery steel for tools of various kinds. Fourth edition. 288 pages. 201 illustrations. Price **\$2.50**

**TRACTORS**

**The Modern Gas Tractor.** By VICTOR W. PAGÉ, M.E.

A complete treatise describing all types and sizes of gasoline, kerosene and oil tractors. Considers design and construction exhaustively, gives complete instructions for care, operation and repair, outlines all practical applications on the road and in the field. The best and latest work on farm tractors and tractor power plants. A work needed by farmers, students, blacksmiths, mechanics, salesmen, implement dealers, designers, and engineers. Second edition, revised and enlarged. 504 pages. Nearly 300 illustrations and folding plates. Price **\$2.00**

**TURBINES**

**Marine Steam Turbines.** By DR. G. BAUER and O. LASCHE. Assisted by E. LUDWIG and H. VOGEL.

Translated from the German and edited by M. G. S. Swallow. The book is essentially practical and discusses turbines in which the full expansion of steam passes through a number of separate turbines arranged for driving two or more shafts, as in the Parsons system, and turbines in which the complete expansion of steam from inlet to exhaust pressure occurs in a turbine on one shaft, as in the case of the Curtis machines. It will enable a designer to carry out all the ordinary calculation necessary for the construction of steam turbines, hence it fills a want which is hardly met by larger and more theoretical works. Numerous tables, curves and diagrams will be found, which explain with remarkable lucidity the reason why turbine blades are designed as they are, the course which steam takes through turbines of various types, the thermodynamics of steam turbine calculation, the influence of vacuum on steam consumption of steam turbines, etc. In a word, the very information which a designer and builder of steam turbines most requires. Large octavo, 214 pages. Fully illustrated and containing eighteen tables, including an entropy chart. Price, net . . . . . **\$3.50**

**WATCH MAKING**

**Watchmaker's Handbook.** By CLAUDIUS SAUNIER.

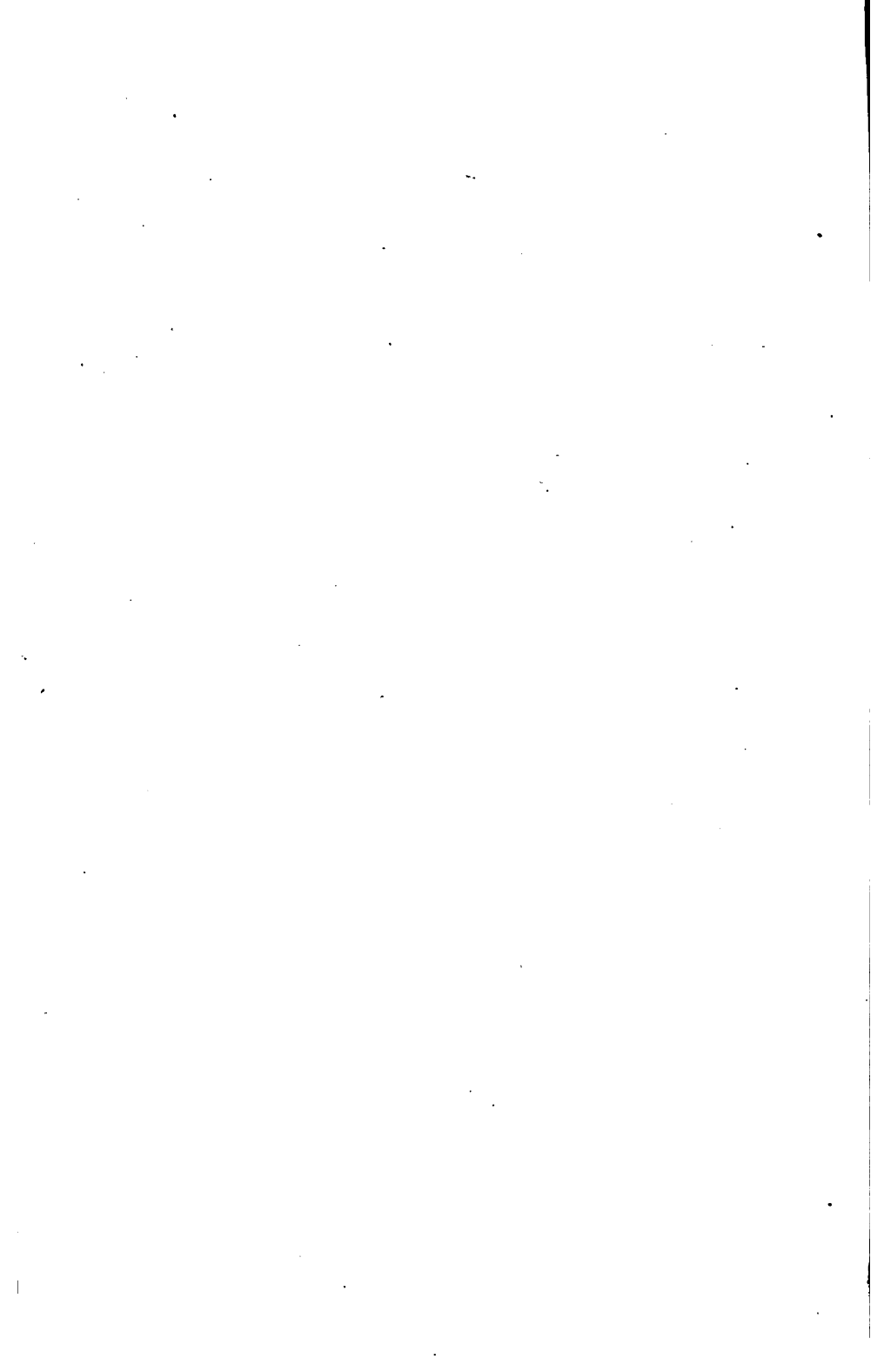
No work issued can compare with this book for clearness and completeness. It contains 498 pages and is intended as a workshop companion for those engaged in watch-making and allied mechanical arts. Nearly 250 engravings and fourteen plates are included. This is the standard work on watch-making. Price . . . . . **\$3.00**

**WELDING**

**Automobile Welding with the Oxy-Acetylene Flame.** By M. KEITH DUNHAM.

Explains in a simple manner apparatus to be used, its care, and how to construct necessary shop equipment. Proceeds then to the actual welding of all automobile parts, in a manner understandable by every one. *Gives principles never to be forgotten.* Aluminum, cast iron, steel, copper, brass, bronze, and malleable iron are fully treated, as well as a clear explanation of the proper manner to burn the carbon out of the combustion head. This book is of utmost value, since the perplexing problems arising when metal is heated to a melting point are fully explained and the proper methods to overcome them shown. 167 pages, fully illustrated. Price . . . . . **\$1.00**







**RETURN TO the circulation desk of any  
University of California Library  
or to the**

**NORTHERN REGIONAL LIBRARY FACILITY  
Bldg. 400, Richmond Field Station  
University of California  
Richmond, CA 94804-4698**

**ALL BOOKS MAY BE RECALLED AFTER 7 DAYS  
2-month loans may be renewed by calling  
(415) 642-6753  
1-year loans may be recharged by bringing books  
to NRLF  
Renewals and recharges may be made 4 days  
prior to due date**

**DUE AS STAMPED BELOW**

**JUL 22 1991**

**DEC 23 1999**

**890**

YL 19261

Jack  
256



